



Service Manual

Revision: September 24, 2012

Lexmark™ X46x series

**7014-431
7014-636
7014-637
7014-63d
7014-63w**

- ***Table of contents***
- ***Start diagnostics***
- ***Safety and notices***
- ***Trademarks***
- ***Index***

LEXMARK™

Lexmark and Lexmark with diamond design are trademarks of Lexmark International, Inc., registered in the United States and/or other countries.

Edition: September 24, 2012

The following paragraph does not apply to any country where such provisions are inconsistent with local law: LEXMARK INTERNATIONAL, INC. PROVIDES THIS PUBLICATION "AS IS" WITHOUT WARRANTY OF ANY KIND, EITHER EXPRESS OR IMPLIED, INCLUDING, BUT NOT LIMITED TO, THE IMPLIED WARRANTIES OF MERCHANTABILITY OR FITNESS FOR A PARTICULAR PURPOSE. Some states do not allow disclaimer of express or implied warranties in certain transactions; therefore, this statement may not apply to you.

This publication could include technical inaccuracies or typographical errors. Changes are periodically made to the information herein; these changes will be incorporated in later editions. Improvements or changes in the products or the programs described may be made at any time.

Comments may be addressed to Lexmark International, Inc., Department D22X/002-1, 740 West New Circle Road, Lexington, Kentucky 40550, U.S.A or e-mail at ServiceInfoAndTraining@Lexmark.com. Lexmark may use or distribute any of the information you supply in any way it believes appropriate without incurring any obligation to you.

References in this publication to products, programs, or services do not imply that the manufacturer intends to make these available in all countries in which it operates. Any reference to a product, program, or service is not intended to state or imply that only that product, program, or service may be used. Any functionally equivalent product, program, or service that does not infringe any existing intellectual property right may be used instead. Evaluation and verification of operation in conjunction with other products, programs, or services, except those expressly designated by the manufacturer, are the user's responsibility.

Lexmark, Lexmark with diamond design and MarkVision are trademarks of Lexmark International, Inc., registered in the United States and/or other countries.

PCL® is a registered trademark of the Hewlett-Packard Company.

All other trademarks are the property of their respective owners.

© 2009 Lexmark International, Inc.

All rights reserved.

UNITED STATES GOVERNMENT RIGHTS

This software and any accompanying documentation provided under this agreement are commercial computer software and documentation developed exclusively at private expense.

Table of contents

Table of contents	iii
Notices and safety information	xi
Laser notice	xi
Lithium warning	xvii
Safety information	xvii
Preface	XX
Change history	v-xx
Conventions	xxi
General information	1-1
Maintenance approach	1-1
Print engine specifications	1-2
Memory	1-2
Print quality settings	1-2
Environment	1-3
Specified operating environment	1-3
Dimensions	1-3
Connectivity and compatibility	1-3
Media trays and supply capacity	1-4
Types of print media	1-5
Media guidelines	1-6
Paper characteristics	1-6
Unacceptable paper	1-6
Selecting paper	1-7
Selecting preprinted forms and letterhead	1-7
Storing paper	1-7
Using recycled paper and other office papers	1-7
Digital imaging specifications	1-9
General specifications	1-9
ADF Scan speed	1-9
ADF Document handling	1-9
Resolution and color depth	1-9
Flatbed document specifications	1-9
Flatbed speed	1-9
Scanner operating environments	1-9
Scan Preview	1-9
Storage environments (packed)	1-9
Storage environments (unpacked)	1-10
Tilt	1-10
Scan and copy specific specifications	1-11
Scan Resolutions	1-11
Output resolutions	1-11
Duplex scan	1-11
Scan file output formats	1-11
Supported compressions	1-11
Supported scan destinations	1-11
Multiple copies	1-11
Reduce / Enlarge	1-11
Fax specifications	1-12
Phone network connectivity	1-12
Fax resolutions	1-12
Miscellaneous FAX specifications	1-12
Tools	1-13

Acronyms	1-14
Diagnostics information	2-1
Start	2-1
Symptom tables	2-1
Service errors (8xx.xx / 9xx.xx's)	2-1
User status and attendance messages	2-1
Symptom tables	2-2
POST symptom table	2-2
Printer symptom table	2-3
Scan / fax / copy symptom table	2-4
Overview of the operator panel and menus	2-5
Understanding the home screen	2-7
Using the touch-screen buttons	2-9
Sample touch screen	2-9
Other touch-screen buttons	2-10
Diagram of the printer menus	2-12
Messages and error codes	2-13
User attendance messages	2-13
Cartridge error messages	2-20
Paper jam error codes (200-series)	2-20
Service error codes	2-26
Fax error codes	2-31
Service checks	2-35
Controller board service check	2-35
Engine board service check	2-36
Cooling fan service check	2-37
Cover interlock switch service check	2-37
Dead machine service check	2-38
Fuser service check	2-39
LVPS/HVPS service check	2-39
Main motor service check	2-40
Media feed clutch service check	2-40
Networking service check	2-41
Operator panel service check	2-43
Paper feed service checks	2-43
Paper jam error indication during POST	2-43
Media picks but stops halfway through the printer	2-44
Media never picks	2-44
Media occasionally mispicks or picks multiple sheets at once	2-44
Media skews	2-45
Media "trees," wrinkles, stacks poorly, or curls	2-45
Option card service check	2-46
USB port service check	2-46
Print quality service checks	2-47
Blank page	2-47
Black page	2-48
Heavy background	2-48
Partial blank image/white spots (no repeating pattern)	2-49
Variation in image density horizontally across page	2-49
Poor fusing of image	2-49
Light print	2-50
White or black lines or bands	2-50
Toner on back of page	2-50
Solving print quality problems	2-51
Printhead service check	2-54
Transfer roll service check	2-54
Tray 2 service check	2-55
840.xx service check	2-55

Black or blank page copy service check	2-57
CCD service check	2-57
Flatbed motor service check	2-57
Flatbed home position service check	2-58
ADF cover open service check	2-59
ADF streak service check	2-59
ADF paper jam service check	2-60
ADF feed errors service check	2-60
ADF Duplex service check	2-62
Modem / fax card service check	2-63
Fax transmission service check	2-64
Fax reception service check	2-66
Escalating a fax issue to second-level support	2-68
Diagnostic aids	3-1
Accessing service menus	3-1
Configuration menu (CONFIG MENU)	3-2
Available menus	3-2
Maintenance Count Value (Maint Cnt Value)	3-3
Reset Maintenance Counter	3-3
Reset Photoconductor Maintenance Counter (Reset PC Cnt)	3-4
USB Scan to Local	3-4
Print Quality Pages	3-4
Menu Settings Page	3-4
Event Log	3-4
Panel Menus	3-4
PPDS Emulation	3-5
Download Emuls	3-5
Factory Defaults	3-6
Energy Conserve	3-6
Min Copy Memory	3-6
Num Pad Job Assist	3-7
Format Fax Storage	3-7
Fax Storage Location	3-7
ADF Edge Erase	3-7
FB Edge Erase	3-7
Scanner Manual Registration	3-8
Disable Scanner	3-9
Paper Prompts	3-9
Envelope Prompts	3-9
Action For Prompts	3-9
Jobs on Disk	3-10
Disk Encryptyion	3-10
Wipe Disk	3-13
Font Sharpening	3-14
Require Standby	3-14
LES Applications	3-15
Key Repeat Initial Delay	3-15
Key Repeat Rate	3-15
Wiper Message	3-15
Clear Custom Status	3-16
USB Speed	3-16
USB PnP	3-16
Exit Configuration Menu (Exit Config Menu)	3-16
Diagnostics menu	3-17
Entering Diagnostics menu	3-17
Registration (printer)	3-18
Quick Test page	3-19
Print Tests	3-20

Input sources	3-20
Print Quality Pages (Prt Quality Pgs)	3-20
Hardware Tests	3-21
Panel Test	3-21
Button Test	3-21
DRAM Test	3-22
Serial 1 Wrap	3-22
USB HS Test Mode	3-23
Duplex Tests	3-24
Quick Test (duplex)	3-24
Top Margin (duplex)	3-25
Sensor Test (duplex)	3-25
Motor Test (duplex)	3-25
Duplex Feed 1	3-26
Duplex Feed 2	3-26
Input Tray Tests	3-26
Feed Tests (input tray)	3-26
Sensor Test (input tray)	3-26
Output bin tests	3-27
Feed Tests (output bins)	3-27
Sensor Test (standard output bin)	3-27
.....	3-27
Base Sensor Test	3-28
DEVICE TESTS	3-28
Quick Disk Test	3-28
Disk Test/Clean	3-28
PRINTER SETUP	3-29
Defaults	3-29
Printed Page Count	3-29
Permanent Page Count	3-29
Serial Number	3-29
Engine Settings 1 through 4	3-29
Model Name	3-29
Configuration ID	3-30
Edge to Edge	3-30
Enable Edge to Edge Copy	3-30
EP SETUP	3-31
.....	3-31
EP Defaults	3-31
Fuser Temperature (Fuser Temp)	3-31
Fuser Page Count	3-31
Warm Up Time	3-31
Transfer	3-32
Print Contrast	3-32
Charge Roll	3-32
Gap Adjust	3-32
Auto Dark Adjust	3-32
Reports	3-32
Menu Settings Page	3-32
EVENT LOG	3-32
Display Log	3-32
Print Log	3-33
Clear Log	3-33
Scanner Tests	3-34
ASIC Test	3-34
Feed Test	3-34
Sensor Tests	3-34
Exit Diagnostics	3-37
Printhead assembly electronic adjustment	3-38

Printhead assembly mechanical adjustment	3-39
SE Menu	3-41
Print SE Menus	3-41
General	3-41
Code Revision Info	3-41
History	3-41
MAC	3-41
NVRAM	3-41
NPAP	3-41
TCP/IP	3-41
Paper jams	3-42
Avoiding jams	3-42
Understanding jam numbers and locations	3-43
Jam messages and their locations	3-44
200 and 201 paper jams	3-44
202 paper jam	3-46
231 paper jam	3-46
233 paper jam	3-48
234 paper jam	3-48
235 paper jam	3-49
240 - 249 paper jams	3-49
250 paper jam	3-50
251 paper jam	3-51
290-294 paper jams	3-52
Repair information	4-1
Handling ESD-sensitive parts	4-1
Removal procedures	4-2
ACM pick tire roller removal	4-3
Card reader removal	4-5
Upper and lower card reader cover removal	4-6
Card reader cable removal	4-7
Controller board removal	4-8
Controller board shield	4-11
Controller board cage	4-14
Controller board fan	4-14
Engine board removal	4-15
Cover open sensor	4-16
Door mount removal	4-17
Duplex removal	4-19
Duplex/main motor gear drive interface removal	4-21
Fan removal	4-24
Front access door removal	4-25
Fuser removal	4-28
Scanner front cover removal	4-31
Left side cover removal	4-33
Front door access cover removal	4-34
Lower front cover removal	4-35
LVPS/HVPS removal	4-37
Main motor gear drive removal	4-40
Manual feed clutch removal	4-42
Manual feed solenoid removal	4-44
Media ACM ASM feeder removal	4-47
Media feed clutch removal	4-50
Media manual input sensor	4-54
Multipurpose feeder removal	4-57
Multipurpose feeder (MPF) feed clutch removal	4-60
Nameplate cover removal	4-63
Operator panel keypad removal	4-64

Operator panel display removal	4-65
Display bezel	4-66
UICC cable removal	4-67
USB cable mount bracket removal	4-68
Operator panel support removal	4-68
Display rotation support removal	4-69
Left rear frame assembly removal	4-70
Right rear frame assembly removal	4-71
Tub assembly removal	4-72
Paper input and duplex sensor assembly removal	4-73
Printhead removal	4-74
Mid rear cover removal	4-76
Rear door and lower rear cover removal	4-77
Rear exit guide assembly with sensor and reversing solenoid removal	4-78
Right side cover removal	4-80
Toner level sensor removal	4-82
Top cover assembly removal	4-83
Transfer roll removal	4-84
Upper front guide assembly removal	4-85
Wear strip (tray 1 and 250-sheet tray 2) removal	4-86
Wear strip (550-sheet tray 2) removal	4-87
Imaging component removals	4-88
ADF unit removal	4-88
Flatbed removal	4-89
Scanner assembly removal	4-91
ADF separator pad	4-98
ADF separator roll assembly	4-99
Kickstand removal	4-100
Output bin LED and lens removal	4-101
ADF cable removal	4-102
Left scanner cover removal	4-103
Right scanner cover removal	4-104
Option board installs and removals	4-105
Lifting the Scanner to the up position	4-105
Installing an Internal Solutions Port (ISP)	4-106
Printer hard disk removal	4-109
Printer hard disk installation on an ISP	4-110
Printer hard disk installation directly on the controller board	4-112
Fax card installation	4-113
Locations and connections	5-1
Locations	5-1
Front view	5-1
Rear view	5-2
Print engine paperpath	5-3
Main boards	5-4
Lexmark X46x series controller board	5-4
Lexmark X46x series engine board	5-5
Lexmark X46x controller and engine board connector pin values	5-6
Preventive maintenance	6-1
Safety inspection guide	6-1
Lubrication specifications	6-1
Scanner glass cleaning	6-1
Maintenance kits	6-1
Parts Catalog	7-1

How to use this parts catalog	7-1
Assembly 1: Covers	7-2
Assembly 2: Imaging	7-4
Assembly 3: Tray assemblies	7-6
Assembly 4: Electronics 2	7-8
Assembly 5: Frame	7-10
Assembly 6: Options	7-12
Assembly 7: Power cords	7-13
Index	I-1
Part number index	I-5

7014-xxx

Notices and safety information

The following laser notice labels may be affixed to this printer.

Laser notice

The printer is certified in the U.S. to conform to the requirements of DHHS 21 CFR Subchapter J for Class I (1) laser products, and elsewhere is certified as a Class I laser product conforming to the requirements of IEC 60825-1.

Class I laser products are not considered to be hazardous. The printer contains internally a Class IIIb (3b) laser that is nominally a 7 milliwatt gallium arsenide laser operating in the wavelength region of 655-675 nanometers. The laser system and printer are designed so there is never any human access to laser radiation above a Class I level during normal operation, user maintenance, or prescribed service condition.

Laser

Der Drucker erfüllt gemäß amtlicher Bestätigung der USA die Anforderungen der Bestimmung DHHS (Department of Health and Human Services) 21 CFR Teil J für Laserprodukte der Klasse I (1). In anderen Ländern gilt der Drucker als Laserprodukt der Klasse I, der die Anforderungen der IEC (International Electrotechnical Commission) 60825-1 gemäß amtlicher Bestätigung erfüllt.

Laserprodukte der Klasse I gelten als unschädlich. Im Inneren des Druckers befindet sich ein Laser der Klasse IIIb (3b), bei dem es sich um einen Galliumarsenlaser mit 7 Milliwatt handelt, der Wellen der Länge 655-675 Nanometer ausstrahlt. Das Lasersystem und der Drucker sind so konzipiert, daß im Normalbetrieb, bei der Wartung durch den Benutzer oder bei ordnungsgemäßer Wartung durch den Kundendienst Laserbestrahlung, die Klasse I übersteigen würde, Menschen keinesfalls erreicht.

Avis relatif à l'utilisation de laser

Pour les Etats-Unis : cette imprimante est certifiée conforme aux provisions DHHS 21 CFR alinéa J concernant les produits laser de Classe I (1). Pour les autres pays : cette imprimante répond aux normes IEC 60825-1 relatives aux produits laser de Classe I.

Les produits laser de Classe I sont considérés comme des produits non dangereux. Cette imprimante est équipée d'un laser de Classe IIIb (3b) (arséniure de gallium d'une puissance nominale de 7 milliwatts) émettant sur des longueurs d'onde comprises entre 655 et 675 nanomètres. L'imprimante et son système laser sont conçus pour impossible, dans des conditions normales d'utilisation, d'entretien par l'utilisateur ou de révision, l'exposition à des rayonnements laser supérieurs à des rayonnements de Classe I.

Avvertenze sui prodotti laser

Questa stampante è certificata negli Stati Uniti per essere conforme ai requisiti del DHHS 21 CFR Sottocapitolo J per i prodotti laser di classe 1 ed è certificata negli altri Paesi come prodotto laser di classe 1 conforme ai requisiti della norma CEI 60825-1.

I prodotti laser di classe non sono considerati pericolosi. La stampante contiene al suo interno un laser di classe IIIb (3b) all'arseniuro di gallio della potenza di 7mW che opera sulla lunghezza d'onda compresa tra 655 e 675 nanometri. Il sistema laser e la stampante sono stati progettati in modo tale che le persone a contatto con la stampante, durante il normale funzionamento, le operazioni di servizio o quelle di assistenza tecnica, non ricevano radiazioni laser superiori al livello della classe 1.

Avisos sobre el láser

Se certifica que, en los EE.UU., esta impresora cumple los requisitos para los productos láser de Clase I (1) establecidos en el subcapítulo J de la norma CFR 21 del DHHS (Departamento de Sanidad y Servicios) y, en los demás países, reúne todas las condiciones expuestas en la norma IEC 60825-1 para productos láser de Clase I (1).

Los productos láser de Clase I no se consideran peligrosos. La impresora contiene en su interior un láser de Clase IIIb (3b) de arseniuro de galio de funcionamiento nominal a 7 milivatios en una longitud de onda de 655 a 675 nanómetros. El sistema láser y la impresora están diseñados de forma que ninguna persona pueda verse afectada por ningún tipo de radiación láser superior al nivel de la Clase I durante su uso normal, el mantenimiento realizado por el usuario o cualquier otra situación de servicio técnico.

Declaração sobre Laser

A impressora está certificada nos E.U.A. em conformidade com os requisitos da regulamentação DHHS 21 CFR Subcapítulo J para a Classe I (1) de produtos laser. Em outros locais, está certificada como um produto laser da Classe I, em conformidade com os requisitos da norma IEC 60825-1.

Os produtos laser da Classe I não são considerados perigosos. Internamente, a impressora contém um produto laser da Classe IIIb (3b), designado laser de arseneto de potássio, de 7 milliwatts, operando numa faixa de comprimento de onda entre 655 e 675 nanómetros. O sistema e a impressora laser foram concebidos de forma a nunca existir qualquer possibilidade de acesso humano a radiação laser superior a um nível de Classe I durante a operação normal, a manutenção feita pelo utilizador ou condições de assistência prescritas.

Laserinformatie

De printer voldoet aan de eisen die gesteld worden aan een laserprodukt van klasse I. Voor de Verenigde Staten zijn deze eisen vastgelegd in DHHS 21 CFR Subchapter J, voor andere landen in IEC 60825-1.

Laserprodukten van klasse I worden niet als ongevaarlijk aangemerkt. De printer is voorzien van een laser van klasse IIIb (3b), dat wil zeggen een gallium arsenide-laser van 7 milliwatt met een golflengte van 655-675 nanometer. Het lasergedeelte en de printer zijn zo ontworpen dat bij normaal gebruik, bij onderhoud of reparatie conform de voorschriften, nooit blootstelling mogelijk is aan laserstraling boven een niveau zoals voorgeschreven is voor klasse 1.

Lasermeddelelse

Printeren er godkendt som et Klasse I-laserprodukt, i overensstemmelse med kravene i IEC 60825-1.

Klasse I-laserprodukter betragtes ikke som farlige. Printeren indeholder internt en Klasse IIIB (3b)-laser, der nominelt er en 7 milliwatt galliumarsenid laser, som arbejder på bølgelængdeområdet 655-675 nanometer. Lasersystemet og printeren er udformet således, at mennesker aldrig udsættes for en laserstråling over Klasse I-niveau ved normal drift, brugervedligeholdelse eller obligatoriske servicebetingelser.

Laserilmoitus

Tämä tulostin on sertifioitu Yhdysvalloissa DHHS 21 CFR Subchapter J -standardin mukaiseksi luokan I (1) - lasertuotteeksi ja muualla IEC 60825-1 -standardin mukaiseksi luokan I lasertuotteeksi.

Luokan I lasertuotteita ei pidetä haitallisina. Tulostimen sisällä on luokan IIIb (3b) laser, joka on nimellisteholtaan 7 mW:n galliumarsenidilaser ja toimii 655 - 675 nanometrin aallonpituuksilla. Laserjärjestelmä ja tulostin ovat rakenteeltaan sellaisia, että käyttäjä ei joudu alttiiksi luokkaa 1 suuremmalle säteilylle normaalin käytön, ylläpidon tai huollon aikana.

Huomautus laserlaitteesta

Tämä kirjoitin on Yhdysvalloissa luokan I (1) laserlaitteiden DHHS 21 CFR Subchapter J -määrityksen mukainen ja muualla luokan I laserlaitteiden IEC 60825-1 -määrityksen mukainen.

Luokan I laserlaitteiden ei katsota olevan vaarallisia käyttäjälle. Kirjoittimessa on sisäinen luokan IIIb (3b) 7 milliwatin galliumarsenidilaser, joka toimii aaltoalueella 655 - 675 nanometriä. Laserjärjestelmä ja kirjoitin on suunniteltu siten, että käyttäjä ei altistu luokan I määräytyksiä voimakkaammalle säteilylle kirjoittimen normaalin toiminnan, käyttäjän tekemien huoltotoimien tai muiden huoltotoimien yhteydessä.

VARO! Avattaessa ja suojalukitus ohitettaessa olet alttiina näkymättömälle lasersäteilylle. Älä katso säteeseen.

WARNING! Osynlig laserstrålning när denna del är öppnad och spärren är urkopplad. Betrakta ej strålen.

Laser-notis

Denna skrivare är i USA certifierad att motsvara kraven i DHHS 21 CFR, underparagraf J för laserprodukter av Klass I (1). I andra länder uppfyller skrivaren kraven för laserprodukter av Klass I enligt kraven i IEC 60825-1.

Laserprodukter i Klass I anses ej hälsovådliga. Skrivaren har en inbyggd laser av Klass IIIb (3b) som består av en laserenhet av gallium-arsenid på 7 milliwatt som arbetar i våglängdsområdet 655-675 nanometer. Lasersystemet och skrivaren är utformade så att det aldrig finns risk för att någon person utsätts för laserstrålning över Klass I-nivå vid normal användning, underhåll som utförs av användaren eller annan föreskriven serviceåtgärd.

Laser-melding

Skriveren er godkjent i USA etter kravene i DHHS 21 CFR, underkapittel J, for klasse I (1) laserprodukter, og er i andre land godkjent som et Klasse I-laserprodukt i samsvar med kravene i IEC 60825-1.

Klasse I-laserprodukter er ikke å betrakte som farlige. Skriveren inneholder internt en klasse IIIb (3b)-laser, som består av en gallium-arsenlaserenhet som avgir stråling i bølgelengdeområdet 655-675 nanometer. Lasersystemet og skriveren er utformet slik at personer aldri utsettes for laserstråling ut over klasse I-nivå under vanlig bruk, vedlikehold som utføres av brukeren, eller foreskrevne serviceoperasjoner.

Avís sobre el Làser

Segons ha estat certificat als Estats Units, aquesta impressora compleix els requisits de DHHS 21 CFR, apartat J, pels productes làser de classe I (1), i segons ha estat certificat en altres llocs, és un producte làser de classe I que compleix els requisits d'IEC 60825-1.

Els productes làser de classe I no es consideren perillosos. Aquesta impressora conté un làser de classe IIIb (3b) d'arseniür de gal.li, nominalment de 7 mil.liwats, i funciona a la regió de longitud d'ona de 655-675 nanòmetres. El sistema làser i la impressora han sigut concebuts de manera que mai hi hagi exposició a la radiació làser per sobre d'un nivell de classe I durant una operació normal, durant les tasques de manteniment d'usuari ni durant els serveis que satisfacin les condicions prescrites.

レーザーに関するお知らせ

このプリンターは、米国ではDHHS 21 CFRサブチャプターJのクラスI (1)の基準を満たしたレーザー製品であることが証明されています。また米国以外ではIEC 825の基準を満たしたクラスIのレーザー製品であることが証明されています。

クラスIのレーザー製品には危険性はないと考えられています。このプリンターはクラスIII b (3 b)のレーザーを内蔵しています。このレーザーは、波長が770 ~ 795ナノメートルの範囲で、通常5ミリワットのガリウム砒化物を放射するレーザーです。このレーザーシステムとプリンターは、通常の操作、ユーザのメンテナンス、規定された修理においては、人体がクラスIのレベル以上のレーザー放射に晒されることのないよう設計されています。

注意：

本打印机被美国认证合乎 DHHS 21 CFR Subchapter I 对分类 I (1) 激光产品的标准，而在其他地区则被认证合乎 IEC 825 的标准。

分类 I 激光产品一般认为不具危险性，本打印机内部含有分类 IIIb (3b) 的激光，在操作过程中会产生 5 毫瓦含镓及砷的微量激光，其波长范围在 770-795 nm 之间。本激光系统及打印机的设计，在一般操作、使用者维护或规定内的维修情况下，不会使人体接触分类 I 以上等级的辐射。

본프린터는 1등급 레이저 제품들에 대한 DHHS 21 CFR Subchapter 3의 규정을 준수하고 있음을 미국에서 인증받았으며, 그외의 나라에서도 IEC 825 규정을 준수하는 1등급 레이저 제품으로서 인증을 받았습니다.

1등급 레이저 제품들은 안전한 것으로 간주됩니다. 본 프린터는 5 밀리와트 갈륨 아르세나이드 레이저로서 770-795 나노미터의 파장대에서 활동하는 Class III (3b) 레이저를 내부에 갖고 있습니다. 본 레이저 시스템과 프린터는 정상 작동 중이나 유지 보수 중 또는 규정된 서비스 상태에서 상기의 Class I 수준의 레이저 방출에 사람이 절대 접근할 수 없도록 설계되어 있습니다.

Lithium warning

	<p>CAUTION</p> <p>This product contains a lithium battery. THERE IS A RISK OF EXPLOSION IF THE BATTERY IS REPLACED BY AN INCORRECT TYPE. Discard used batteries according to the battery manufacturer's instructions and local regulations.</p>
---	--

Safety information

- The safety of this product is based on testing and approvals of the original design and specific components. The manufacturer is not responsible for safety in the event of use of unauthorized replacement parts.
- The maintenance information for this product has been prepared for use by a professional service person and is not intended to be used by others.
- There may be an increased risk of electric shock and personal injury during disassembly and servicing of this product. Professional service personnel should understand this and take necessary precautions.
-  **CAUTION:** When you see this symbol, there is a danger from hazardous voltage in the area of the product where you are working. Unplug the product before you begin, or use caution if the product must receive power in order to perform the task.

Consignes de sécurité

- La sécurité de ce produit repose sur des tests et des agréments portant sur sa conception d'origine et sur des composants particuliers. Le fabricant n'assume aucune responsabilité concernant la sécurité en cas d'utilisation de pièces de rechange non agréées.
- Les consignes d'entretien et de réparation de ce produit s'adressent uniquement à un personnel de maintenance qualifié.
- Le démontage et l'entretien de ce produit pouvant présenter certains risques électriques, le personnel d'entretien qualifié devra prendre toutes les précautions nécessaires.
-  **ATTENTION :** Ce symbole indique la présence d'une tension dangereuse dans la partie du produit sur laquelle vous travaillez. Débranchez le produit avant de commencer ou faites preuve de vigilance si l'exécution de la tâche exige que le produit reste sous tension.

Norme di sicurezza

- La sicurezza del prodotto si basa sui test e sull'approvazione del progetto originale e dei componenti specifici. Il produttore non è responsabile per la sicurezza in caso di sostituzione non autorizzata delle parti.
- Le informazioni riguardanti la manutenzione di questo prodotto sono indirizzate soltanto al personale di assistenza autorizzato.
- Durante lo smontaggio e la manutenzione di questo prodotto, il rischio di subire scosse elettriche e danni alla persona è più elevato. Il personale di assistenza autorizzato deve, quindi, adottare le precauzioni necessarie.
-  **ATTENZIONE:** Questo simbolo indica la presenza di tensione pericolosa nell'area del prodotto. Scollegare il prodotto prima di iniziare o usare cautela se il prodotto deve essere alimentato per eseguire l'intervento.

Sicherheitshinweise

- Die Sicherheit dieses Produkts basiert auf Tests und Zulassungen des ursprünglichen Modells und bestimmter Bauteile. Bei Verwendung nicht genehmigter Ersatzteile wird vom Hersteller keine Verantwortung oder Haftung für die Sicherheit übernommen.
- Die Wartungsinformationen für dieses Produkt sind ausschließlich für die Verwendung durch einen Wartungsfachmann bestimmt.
- Während des Auseinandernehmens und der Wartung des Geräts besteht ein zusätzliches Risiko eines elektrischen Schlags und körperlicher Verletzung. Das zuständige Fachpersonal sollte entsprechende Vorsichtsmaßnahmen treffen.
-  **ACHTUNG:** Dieses Symbol weist auf eine gefährliche elektrische Spannung hin, die in diesem Bereich des Produkts auftreten kann. Ziehen Sie vor den Arbeiten am Gerät den Netzstecker des Geräts, bzw. arbeiten Sie mit großer Vorsicht, wenn das Produkt für die Ausführung der Arbeiten an den Strom angeschlossen sein muß.

Pautas de Seguridad

- La seguridad de este producto se basa en pruebas y aprobaciones del diseño original y componentes específicos. El fabricante no es responsable de la seguridad en caso de uso de piezas de repuesto no autorizadas.
- La información sobre el mantenimiento de este producto está dirigida exclusivamente al personal cualificado de mantenimiento.
- Existe mayor riesgo de descarga eléctrica y de daños personales durante el desmontaje y la reparación de la máquina. El personal cualificado debe ser consciente de este peligro y tomar las precauciones necesarias.
-  **PRECAUCIÓN:** este símbolo indica que el voltaje de la parte del equipo con la que está trabajando es peligroso. Antes de empezar, desenchufe el equipo o tenga cuidado si, para trabajar con él, debe conectarlo.

Informações de Segurança

- A segurança deste produto baseia-se em testes e aprovações do modelo original e de componentes específicos. O fabricante não é responsável pela segurança, no caso de uso de peças de substituição não autorizadas.
- As informações de segurança relativas a este produto destinam-se a profissionais destes serviços e não devem ser utilizadas por outras pessoas.
- Risco de choques eléctricos e ferimentos graves durante a desmontagem e manutenção deste produto. Os profissionais destes serviços devem estar avisados deste facto e tomar os cuidados necessários.
-  **CUIDADO:** Quando vir este símbolo, existe a possível presença de uma potencial tensão perigosa na zona do produto em que está a trabalhar. Antes de começar, desligue o produto da tomada eléctrica ou seja cuidadoso caso o produto tenha de estar ligado à corrente eléctrica para realizar a tarefa necessária.

Informació de Seguretat

- La seguretat d'aquest producte es basa en l'avaluació i aprovació del disseny original i els components específics.
El fabricant no es fa responsable de les qüestions de seguretat si s'utilitzen peces de recanvi no autoritzades.
- La informació pel manteniment d'aquest producte està orientada exclusivament a professionals i no està destinada a ningú que no ho sigui.
- El risc de xoc elèctric i de danys personals pot augmentar durant el procés de desmuntatge i de servei d'aquest producte. El personal professional ha d'estar-ne assabentat i prendre les mesures convenients.
-  **PRECAUCIÓ:** aquest símbol indica que el voltatge de la part de l'equip amb la qual esteu treballant és perillós. Abans de començar, desendolieu l'equip o extremeu les precaucions si, per treballar amb l'equip, l'heu de connectar.

안전 사항

- 본 제품은 원래 설계 및 특정 구성품에 대한 테스트 결과로 안정성이 입증된 것입니다. 따라서 무허가 교체부품을 사용하는 경우에는 제조업체에서 안전에 대한 책임을 지지 않습니다.
- 본 제품에 관한 유지 보수 설명서는 전문 서비스 기술자용으로 작성된 것이므로, 비전문가는 사용할 수 없습니다.
- 본 제품을 해체하거나 정비할 경우, 전기적인 충격을 받거나 상처를 입을 위험이 커집니다. 전문 서비스 기술자는 이 사실을 숙지하고, 필요한 예방 조치를 취하도록 하십시오.
-  **주의:** 이 표시는 해당영역에서 고압전류가 흐른다는 위험 표시입니다. 시작전에 플러그를 뽑으시거나, 주의를 기울여 주시기 바랍니다.

安全信息

- 本产品的安全性以原来设计和特定产品的测试结果和认证为基础。万一使用未经许可的替换部件，制造商不对安全性负责。
- 本产品的维护信息仅供专业服务人员使用，并不打算让其他人使用。
- 本产品在拆卸、维修时，遭受电击或人员受伤的危险性会增高，专业服务人员对这点必须有所了解，并采取必要的预防措施。
-  **切记:** 当您看到此符号时，说明在您工作的产品区域有危险电压的存在。请在开始操作前拔掉产品的电源线，或者在产品必须使用电源来执行任务时，小心从事。

Preface

This manual contains maintenance procedures for service personnel. It is divided into the following chapters:

1. **General information** contains a general description of the printer and the maintenance approach used to repair it. Special tools and test equipment, as well as general environmental and safety instructions, are discussed.
2. **Diagnostic information** contains an error indicator table, symptom tables, and service checks used to isolate failing field replaceable units (FRUs).
3. **Diagnostic aids** contains tests and checks used to locate or repeat symptoms of printer problems.
4. **Repair information** provides instructions for making printer adjustments and removing and installing FRUs.
5. **Connector locations** uses illustrations to identify the connector locations and test points on the printer.
6. **Preventive maintenance** contains the lubrication specifications and recommendations to prevent problems.
7. **Parts catalog** contains illustrations and part numbers for individual FRUs.

Change history

Revision date	Updates
2012/09/24	Deleted reference to wiring diagram on page 5-6.
2012/09/19	Changed ADF separator pad PN from 40X5472 to 40X8419.
2012/07/10	Updated the description for the "80 Routine Maintenance" on page 2-18.
2012/05/02	Replaced all references to 40X5471 to 40X7545 for the ADF separator roll in "Imaging" on page 7-5 and in "Maintenance kits" on page 6-1.
2012/02/08	Added the following part numbers in "Imaging" on page 7-5: <ul style="list-style-type: none"> • 40X7546 for the ADF hinge, right • 40X7547 for the ADF hinge, left
2011/10/28	Added this warning: "Warning: Do not strip the insulation off the red and black wires. The connectors will not work if the insulation is removed," in step 8 of "Media feed clutch removal" on page 4-50.
2011/9/14	Revised the media feed clutch assembly removal procedure in "Media feed clutch removal" on page 4-50.
2011/07/28	<ul style="list-style-type: none"> • Updated the "Printhead removal" on page 4-74. • Updated the "Scanner assembly removal" on page 4-91.

Conventions

Note: A note provides additional information.

Warning: A warning identifies something that might damage the product hardware or software.

There are several types of caution statements:

	<p>CAUTION</p> <p>A caution identifies something that might cause a servicer harm.</p>
---	---

	<p>CAUTION</p> <p>This type of caution indicates there is a danger from hazardous voltage in the area of the product where you are working. Unplug the product before you begin, or use caution if the product must receive power in order to perform the task.</p>
---	--

	<p>CAUTION</p> <p>This type of caution indicates a hot surface.</p>
---	--

	<p>CAUTION</p> <p>This type of caution indicates a tipping hazard.</p>
---	---

1. General information

The Lexmark™ X46x series MFPs are monochrome multifunction laser printers designed for single users or small workgroups. The X46x MFPs allow users to print, copy, scan, and fax documents. This book contains information on X46x series MFPs.



Maintenance approach

The diagnostic information in this manual leads to the correct field replaceable unit (FRU) or part. Use the error code charts, symptom index, and service checks to determine the symptom and repair the failure. See **“Diagnostics information” on page 2-1** for more information. See **“Repair information” on page 4-1** to help identify parts. After completing the repair, perform tests as needed to verify the repair.

Print engine specifications

Memory

Item	Lexmark X463, X464	Lexmark X466
Standard memory	128MB	128MB
Maximum memory	640MB	640MB
Optional memory		
128MB DDR SDRAM unbuffered DIMMS	✓	✓
256MB DDR SDRAM unbuffered DIMMS	✓	✓
512MB DDR SDRAM unbuffered DIMMS	✓	✓
Optional flash memory		
256 MB via flash memory card	✓	✓
Optional font cards (DBCS)	✓	✓
Option slots		
ISP (INA) slot	1	1
Memory slots	1	1
Flash memory/option card	2 ¹	2 ¹
¹ Both slots are active for either a 256MB Flash memory card, a font card, or a DLE. Multiple Flash, font, or DLE cards are not supported.		

Print quality settings

Item	Lexmark X463, X464	LexmarkX466
Print resolution		
1200 Image quality ¹	✓	✓
2400 Image quality ²	✓	✓
600 X 600 dpi	✓	✓
1200 X 1200 dpi ³	✓	✓
¹ 1200 Image quality is defined as 600 dpi with 2 bit IET (Image Technology) default mode for all models.		
² 2400 Image quality is defined as 600 dpi with 4 bit IET.		
³ True 1200 dpi at 1/2 the rated speed		

Environment

Specified operating environment

Operating temperature range - 16 to 32 degrees C (60 to 90 degrees F)

Humidity - 8 to 80% Relative humidity

Altitude 0 to 3048 meters (10,000 ft)

Dimensions

Height - 23.3 in (297mm)

Width - 20.87 in (530 mm)

Depth - 15.5 in (394 mm) w/ input tray set to letter, 16.14 in (410 mm) w/ input tray set to legal.

Connectivity and compatibility

Item	Lexmark X463, X464	LexmarkX466
Data stream emulations		
Host based printing	✓	✓
PCL 5e and PCL 6	✓	✓
PostScript 3	✓	✓
PPDS migration tool	✓	✓
PDF v1.6	✓	✓
XPS ¹	✓	✓
HTML (including DBCS)	✓	✓
Direct image	✓	✓
Compatibility	Windows/Macintosh/Linux	Windows/Macintosh/Linux
Standard local connections		
USB*	✓	✓
Standard network connections		
Ethernet (10/100 Base Tx)	✓	✓
Wireless ethernet 802.11b/g/n	x	✓
Optional local connections		
Optional network connections: external print server support	✓	✓
*All models are USB 2.0 Certified devices supporting Hi-Speed data transfer.		
¹ Includes the HD photo image format		
² Includes support for the following graphics formats: TIFF, TIF, JPG, GIF, PNG, BMP, PCX, AND DCX		

Media trays and supply capacity

Item	Lexmark X463, X464	Lexmark X466
Available input trays		
Integrated 250-sheet tray	✓	✓
50-sheet MP feeder	✓	✓
1-sheet manual feed slot	x	x
Optional input sources		
250-sheet drawer	✓	✓
550-sheet drawer	✓	✓
Maximum input sheet capacity	850 (excluding envelopes)	850 (excluding envelopes)
Manual/integrated print duplex	Integrated	Integrated
Envelope conditioning	x	x
Available output trays		
Standard 150-sheet sensing bin	✓	✓
Toner and photoconductor		
Toner cartridge	1,500 standard pages SWE ¹ 3,500 standard pages SWE ¹	7,000 standard pages SWE ¹
High toner cartridge	9,000 standard pages ¹	9,000 standard pages ¹ 15,000 standard pages ¹
Photoconductor kit	Up to 30,000 ²	Up to 30,000 ²
¹ Declared value in accordance with ISO/IEC 19752		
² Up to 30,000 pages, based on an average of 3 pages per job and approximately 5% coverage per page. Yields may vary based on customer usage.		

Types of print media

Note: Ensure trays are properly loaded. Never mix media types within a tray.

Source	Sizes	Types	Weight	Input capacity* (sheets)
Input tray 1 (250-sheet tray)	A4, A5, A6, JIS ¹ -B5, letter, legal, executive, oficio (Mexico) ² , folio ² , statement	Plain paper, recycled, labels, bond, letterhead, preprinted, colored paper, light paper, heavy paper, rough/cotton, custom type [x]	60-90 g/m ² (16-24 lb)	<ul style="list-style-type: none"> • 250 paper • 50 labels**
2nd Drawer option (250/550-sheet drawer)	A4, A5, JIS ¹ -B5, letter, legal, executive, oficio (Mexico) ² , folio ² , statement	Plain paper, recycled, labels, bond, letterhead, preprinted, colored paper, light paper, heavy paper, rough/cotton, custom type [x]	60-90 g/m ² (16-24 lb)	<ul style="list-style-type: none"> • 250 paper • 550 paper • 50 labels**
Multipurpose feeder	A4, A5, A6, JIS ¹ -B5, letter, legal, executive, oficio (Mexico) ² , folio ² , statement	Plain paper, transparency, recycled, labels, bond, letterhead, preprinted, colored paper, light paper, heavy paper, rough/cotton, custom type [x]	60-163 g/m ² (16-43 lb)	<ul style="list-style-type: none"> • 50 paper • 15 lables** • 10 transparencies
		Card stock***	<ul style="list-style-type: none"> • 120-163 g/m² (16-43 lb) Index Bristol • 75-163 g/m² (46-100 lb) Tag 	20
	7 ¾, 9, 10, DL, C5, B5, other	Envelopes Rough envelopes	75 g/m ² (20 lb)	7
Duplex	A4, letter, legal, oficio (Mexico) ² , folio ²	Plain paper, recycled, bond, letterhead, preprinted, colored paper, light paper, heavy paper, custom type [x]	60-90 g/m ² (16-24 lb)	

* Capacity for 20 lb print media, unless otherwise noted.

** Use for occasional printing only.

¹Japanese Industry Standard

² If a source supports size sensing and is activated, then neither the "oficio" value nor the "folio" value appears in that source's list of supported media sizes. These values only appear in a source's list of supported media sizes either when the source is non-size sensing or when the source's size sensing hardware is deactivated and then the device is power cycled.

Media guidelines

Paper characteristics

The following paper characteristics affect print quality and reliability. Consider these characteristics when evaluating new paper stock.

- **Weight**—The printer can automatically feed paper weights from 60 to 176 g/m² (16 to 47 lb bond) grain long. Paper lighter than 75 g/m² (20 lb) might not be stiff enough to feed properly, causing jams. For best performance, use 80 g/m² (21 lb bond) grain long paper. For paper smaller than 182 x 257 mm (7.2 x 10.1 in.), we recommend 90 g/m² or heavier paper.
- **Curl**—Curl is the tendency for paper to curl at its edges. Excessive curl can cause paper feeding problems. Curl can occur after the paper passes through the printer, where it is exposed to high temperatures. Storing paper unwrapped in hot, humid, cold, or dry conditions, even in the trays, can contribute to paper curling prior to printing and can cause feeding problems.
- **Smoothness**—Paper smoothness directly affects print quality. If paper is too rough, toner cannot fuse to it properly. If paper is too smooth, it can cause paper feeding or print quality issues. Always use paper between 100 and 300 Sheffield points; however, smoothness between 150 and 200 Sheffield points produces the best print quality.
- **Moisture content**—The amount of moisture in paper affects both print quality and the ability of the printer to feed the paper correctly. Leave paper in its original wrapper until it is time to use it. This limits the exposure of paper to moisture changes that can degrade its performance. Condition paper before printing by storing it in its original wrapper in the same environment as the printer for 24 to 48 hours before printing. Extend the time several days if the storage or transportation environment is very different from the printer environment. Thick paper may also require a longer conditioning period.
- **Grain direction**—Grain refers to the alignment of the paper fibers in a sheet of paper. Grain is either grain long, running the length of the paper, or grain short, running the width of the paper. For 60 to 176 g/m² (16 to 47 lb bond) paper, use grain long fibers.
- **Fiber content**—Most high-quality xerographic paper is made from 100% chemically treated pulped wood. This content provides the paper with a high degree of stability resulting in fewer paper feeding problems and better print quality. Paper containing fibers such as cotton possesses characteristics that can negatively affect paper handling.

Unacceptable paper

The following paper types are not recommended for use with the printer:

- Preprinted papers with chemicals that may contaminate the printer
- Preprinted papers that can be affected by the temperature in the printer fuser
- Coated papers (erasable bond), synthetic papers, thermal papers
- Rough-edged, rough or heavily textured surface papers, or curled papers
- Recycled papers containing more than 25% post-consumer waste, and weighing more than 80 g/m²
- Paper weighing less than 60 g/m² (16 lb)
- Multiple-part forms or documents

Selecting paper

Using appropriate paper prevents jams and helps ensure trouble-free printing. To help avoid jams and poor print quality:

- Always use new, undamaged paper.
- Before loading paper, know the recommended print side of the paper. This information is usually indicated on the paper package.
- Do not use paper that has been cut or trimmed by hand.
- Do not mix paper sizes, types, or weights in the same source; mixing results in jams.
- Do not use coated papers unless they are specifically designed for electrophotographic printing.

Selecting preprinted forms and letterhead

Use these guidelines when selecting preprinted forms and letterhead:

- Use grain long for 60 to 176 g/m² weight paper.
- Use only forms and letterhead printed using an offset lithographic or engraved printing process.
- Avoid papers with rough or heavily textured surfaces.

Use papers printed with heat-resistant inks designed for use in xerographic copiers. The ink must be able to withstand temperatures up to 200°C (392°F) without melting or releasing hazardous emissions. Use inks that are not affected by the resin in toner. Inks that are oxidation-set or oil-based generally meet these requirements; latex inks might not. When in doubt, contact the paper supplier.

Preprinted papers such as letterhead must be able to withstand temperatures up to 200°C (392°F) without melting or releasing hazardous emissions.

Storing paper

Use these paper storage guidelines to help avoid jams and uneven print quality:

- For best results, store paper where the temperature is 21°C (70°F) and the relative humidity is 40%. Most label manufacturers recommend printing in a temperature range of 18 to 24°C (65 to 75°F) with relative humidity between 40 and 60%.
- Store paper in cartons when possible, on a pallet or shelf, rather than on the floor.
- Store individual packages on a flat surface.
- Do not store anything on top of individual paper packages.

Using recycled paper and other office papers

As an environmentally conscious company, Lexmark supports the use of recycled office paper produced specifically for use in laser (electrophotographic) printers. In 1998, Lexmark presented to the US government a study demonstrating that recycled paper produced by major mills in the US fed as well as non-recycled paper. However, no blanket statement can be made that all recycled paper will feed well. Lexmark consistently tests its printers with recycled paper (20–100% post-consumer waste) and a variety of test paper from around the world, using chamber tests for different temperature and humidity conditions. Lexmark has found no reason to discourage the use of today's recycled office papers, but generally the following property guidelines apply to recycled paper.

- Low moisture content (4–5%)
- Suitable smoothness (100–200 Sheffield units, or 140–350 Bendtsen units, European)
 - Note:** Some much smoother papers (such as premium 24 lb laser papers, 50–90 Sheffield units) and much rougher papers (such as premium cotton papers, 200–300 Sheffield units) have been engineered to work very well in laser printers, despite surface texture. Before using these types of paper, consult your paper supplier.
- Suitable sheet-to-sheet coefficient of friction (0.4–0.6)
- Sufficient bending resistance in the direction of feed

Recycled paper, paper of lower weight (<60 g/m² [16 lb bond]) and/or lower caliper (<3.8 mils [0.1 mm]), and paper that is cut grain-short for portrait (or short-edge) fed printers may have lower bending resistance than is required for reliable paper feeding. Before using these types of paper for laser (electrophotographic) printing, consult your paper supplier. Remember that these are general guidelines only and that paper meeting these guidelines may still cause paper feeding problems in any laser printer (for example, if the paper curls excessively under normal printing conditions).

Digital imaging specifications

General specifications

ADF Scan speed

Simplex ADF - Up to 25 ppm

Duplex ADF - Up to 35 ppm (page sides)

ADF Document handling

ADF input capacity - 50 sheets.

ADF output capacity - 50 sheets.

ADF document width - 4.9" (125mm) to 8.5" (216mm)

ADF document length - 5" (127mm) to 14.0" (356mm)

Resolution and color depth

- Flatbed maximum optical resolution - 600 x 600 dpi (Mono), 600 x 300 dpi (Color), with final resolution of 300 x 300 dpi
- CDD 1200 dpi, and 600 dpi. Selectable through electronics
- Color depth - 48 bit RGB output. 16 bit / channel
- Mono ADF optical resolution - Max 600 x 600 dpi
- Color ADF resolution - Max. 600 x 300 dpi (final resolution of 300 x 300 dpi)

Flatbed document specifications

- Flatbed scan area - Max. 8.5" x 14" (216mm x 355.6mm)
- Document size- Up to A4 and legal
- 4.5" x 5.5" to 8.5"x14" (SEF)

Flatbed speed

3 seconds to scan, 3 seconds to return.

Scanner operating environments

- Temperature - 16°C to 32°C (60° to 90° fahrenheit)
- Humidity - 8% RH to 80% RH
- Altitude 0 to 3048M (10000 feet)

Scan Preview

- Available on disk equipped models.

Storage environments (packed)

- Temperature - -40°C to 43.3°C (-40° to 110° fahrenheit)
- Humidity - 5% RH to 95% RH
- Altitude max - .25 atmosheric pressure

Storage environments (unpacked)

- Temperature - 0° to 40°C
- Humidity - 5 to 80% relative humidity

Tilt

This device should operate within the stated parameters when it is level within 10mm from front to back and 10mm side to side.

Scan and copy specific specifications

Scan Resolutions

- Optical - 600 dpi (Local Twain only)
- Enhanced (vial Lexmark Scan Center) - 1200 X 1200 dpi, 2400 X 2400 dpi, 4800 X 4800 dpi, 9600 X 9600 dpi, 19200 X 19200 dpi

Output resolutions

- Mono - 600 X 600 dpi
- Color - 300 X 300 dpi

Duplex scan

Duplex and copy is available on all X46x series models.

Scan file output formats

- TIFF
- JPEG
- PDF and secure PDF
- XPS

Supported compressions

- PDF - (1 bit,- JBIG2 CCIT G4, Flate), (8/24 bit - Flate JPEG)
- TIFF - (1 bit - CCITT G4), (8/24 bit - Packbits, LZW)
- JPG - (8/24 bit-JPG)

Supported scan destinations

- Temporary profile from a user's PC
- FTP
- Scan to PC via network TWAIN
- Scan to PC using Web applet
- Scan to E-Mail
- Scan to USB
- Windows network folder (requires installing embedded scan to folder application)

Multiple copies

999 copies maximum

Reduce / Enlarge

-25% to 400%

Fax specifications

Phone network connectivity

Phone networks types supported	PSTN or analog PABX (RJ-11)
ITU COMPATIBILITY Standard Resolution Fine Superfine Ultrafine Coding	Group 3/ECM 8 x 3.85 pels/mm (200X100dpi) (204x98) 8 x 7.7 pels/mm (200X200dpi) (204x196) 11.8 x 11.8 pels/mm (300x300 dpi) (204x391) 15.7 x 15.7 pels/mm (600x600 dpi) (612x587) ITU T.4 and T.6 (MH, MR, MMR, JPEG)
Modem speed	V.34 2,400-33,600 BPS, V.17 7,200-14,400 BPS, V.27 2,400-4,800 BPS, V.29 7,200-9,600 BPS
Compression	MH, MR, MMR, JPEG
Error correction	ITU T.30
Line interface selection	
Modular Plug Out Band Signal Level	Dual RJ-11C Guaranteed North American and Europe PTT standard
Input Level Range Ring Detection	-16dBm ~ -59dBm Complies with all regulatory requirements

Fax resolutions

Receive	200x100 dpi, 200x200 dpi, 300x300 dpi, 400x400 dpi, 204x98 dpi, 204x196 dpi, 204x391 dpi, 408x391 dpi
Send	200x100dpi, 200x200 dpi, 300x300 dpi

Miscellaneous FAX specifications

Fax memory	4 MB Flash (More than 320 pages based on ITU chart #1) User selectable parameters are stored in NVRAM.
Speed dial	Non hard drive model - 500 Hard drive - >1800
Transmission	Approximately 3 seconds per page
Fax Storage	X464e-12mb (.5mb Fax logs + 11.5mb Fax Storage) 900 pgs X466e-80GB Hard disk space 4096 fax jobs
Color fax	Yes
Fax from PC	Yes. Supported using PostScript driver for both local and network attach modes.
Caller ID	Yes
Junk FAX blocking	Yes - based on caller ID and remote station ID
Tone/Pulse	Tone: Default, Pulse: Yes
Fax forward	Yes
Broadcasting	Yes. 46 destinations
External phone interface	Yes
Manual mode	Yes
Fax shortcuts	Yes.
Fax content	Text, text/photo, photo
Fax perseveration	Yes
Halftoning	Yes

Tools

The removal and adjustment procedures require the following tools and equipment:

- Spring hook
- Needle nose pliers
- Volt-ohmmeter
- #1 and #2 Phillips screwdriver
- Slotted screwdriver

Acronyms

ac	Alternating Current
ACM	Autocompensator Mechanism (or paper feed)
ADF	Automatic document feeder
AFE	Analog front end
AIO	All-In-One
APS	Automatic Paper Size
ASIC	Application Specific Integrated Circuit
BLDC	Brushless DC Motor
BOR	Black Only Retract
CCD	Charge-Couple Device
CCFL	Cold Cathode Fluorescent Lamp
CCW	Counter clockwise
CDB	Command Descriptor Blocks
CMYK	Cyan yellow magenta black
CPU	Central processing unit
CRC	Cyclic redundancy check
CRU	Customer Replaceable Unit
CSU	Customer Setup
CW	Clockwise
DBCS	Double byte character set
dc	Direct Current
DIMM	Dual Inline Memory Module
DLE	Downloadable emulator
DRAM	Dynamic random access memory
DVM	Digital multimeter
ECC	Error correcting code
ECM	Error correction mode
EDO	Enhanced Data Out
EEPROM	Electrical Erasable Programmable Read-Only Memory
ENA	External Network Adapter
EOL	End of line
EP	Electrophotographic process
EPROM	Erasable programmable read-only memory
ESD	Electrostatic Discharge
FB	Flatbed
FD	Facedown
FRU	Field replaceable unit
FU	Face up
GB	Gigabyte
GFI	Ground Fault Interrupter
GHz	Gigahertz
HBP	Host Based Printing
HCF	High-capacity feeder
HCIT	High-capacity Input Tray
HCOF	High-Capacity Output Finisher
HCPF	High-capacity feeder
HTML	Hypertext markup language
HV	High Voltage
HVPS	High voltage power supply
HVU	High voltage unit
Hz	Hertz

INTL	International
ITC	Internal Tray Card
ITU	Image Transfer Unit
K	Black (Key)
LAN	Local area network
LASER	Light amplification by stimulated emission of radiation
LCD	Liquid crystal display
LCM	Liquid Crystal Module
LD	Laser Diode
LED	Light emitting diode
LEF	Long edge feed
LES	Lexmark Embedded Solution (applications)
LSU	Laser Scanning Unit
LV	Low Voltage
LVPS	Low voltage power supply
MB	Megabyte
MDC	Motor Driver Control
MFD	Multifunction Device
MFP	Multifunction Printer
MH	Message handling
MIF	Motor interface
mm	millimeter
MMR	Modified modified read
MPF	Multipurpose feeder
MR	Modem ready
MROM	Masked Read Only Memory
MS	Microswitch
NAND	NAND (usage: NAND gate)
NVM	Nonvolatile Memory
NVRAM	Nonvolatile Random Access Memory
OCF	Operator correctable failure
OEM	Original Equipment Manufacturer
OHP	Overhead projector
OPC	Optical photo conductor
OPT	Optical Sensor
PC	Photoconductor
PDF	Portable Document Format
PICS	Problem isolation charts
PIN	Personal identification number
PIXEL	Picture element
PJL	Printer Job Language
POR	Power-on reset
POST	Power-on self test
PPDS	Personal Printer Data Stream
ppm	Pages per minute
PQET	Print Quality Enhancement Technology
PRC	Peoples' Republic of China
PSC	Parallel Synchronous Communications
PSD	Position Sensing Device
PSO	Participating Standards Organization
PWM	Pulse Width Modulation
RAM	Random access memory
RFID	Radio frequency identification
RH	Relative humidity

RIP	Raster image processor
ROM	Read-only memory
ROS	Read-only storage
RPM	Revolutions Per Minute
SCC	Scanner Control Card
SDRAM	Synchronous Dynamic Random Access Memory
SEF	Short edge feed
SIMM	Single Inline Memory Module
SOL	Solenoid
SOS	Start of scan
SRAM	Static random access memory
TAR	Toner Add Roll
TPS	Toner Patch Sensing
TTM	Tandem Tray Module
TVOC	Total Volatile Organic Compound
UAT	Universally Adjustable Tray
UPR	Used Parts Return
USB	Universal Serial Bus
V	Volts
V ac	Volts alternating current
V dc	Volts direct current
VOIP	Voice over internet protocol
VOM	Volt Ohmmeter
VTB	Vacuum Transport Belt
XPS	XML Paper Specification

2. Diagnostics information

Start



CAUTION: Unplug power from the printer before connecting or disconnecting any cable, assembly, or electronic card. This is a precaution for personal safety and to prevent damage to the printer.

Use the service error code, user status message, user error message, symptom table, service checks, and diagnostic aids in this chapter to determine the corrective action necessary to repair a malfunctioning printer. They will lead you to solutions or service checks, including use of various tests.

Symptom tables

If your machine completes the **“Power-On Self Test (POST) sequence”** on page 2-1 without an error and you have a symptom, then go to **“Service error codes”** on page 2-26. Locate your symptom, and take the appropriate action.

Service errors (8xx.xx / 9xx.xx’s)

If a service error code appears while you are working on the machine, then go to **“Service error codes”** on page 2-26, and take the indicated action for that error.

Service error codes are indicated by a three-digit error code followed by a period and additional numbers in the format XXX.YY. In most cases, five digits are shown.

User status and attendance messages

- User status messages provide the user with information on the current status of the printer. Ready displays on the first line of the display unless invoked, and then Power Saver displays. If a user status message is displayed, then go to **“Service error codes”** on page 2-26.
- User attendance messages are indicated by a two- or three-digit error code that provides the user with information that explains a problem with a print cartridge, paper jam, option, port, and so on. If a user error message displays, then go to **“User attendance messages”** on page 2-13 and **“Paper jam error codes (200-series)”** on page 2-20.

Power-On Self Test (POST) sequence

The following is an example of the events that occur during the POR sequence when the printer is turned on.

1. Display screen illuminates and the memory test is initiated.
2. The Lexmark splash screen is displayed with a progress bar. The firmware revision is displayed in the lower left of the screen.
3. Scanner calibration and testing initiates when the progress bar is two thirds finished.
4. Not Ready will be displayed if the cover is open.
5. Any cartridge errors, such as Defective Cartridge, are displayed in the message area at the bottom of the screen.
6. Applicable maintenance messages are displayed.
7. Applicable toner low messages are displayed.
8. The red indicator light will flash if there are errors.
9. The printer displays Ready.

Symptom tables

POST symptom table

Symptom	Action
The main motor, cooling fan, and fuser do not come on.	See “Cover interlock switch service check” on page 2-37.
POST completes, but the display does not come on.	See “Operator panel service check” on page 2-43.
Main motor does not come on.	See “Main motor service check” on page 2-40.
Fan does not come on.	See “Cooling fan service check” on page 2-37.
Fuser does not cycle.	See “Fuser service check” on page 2-39.
Fuser does not turn on and off.	See “Fuser service check” on page 2-39.
The paper feed picks and tries to feed media.	See “Paper feed service checks” on page 2-43.

Note: Investigate any displayed codes before proceeding with these symptoms. For example, a missing toner cartridge will prevent POST from completing.

Printer symptom table

Symptom	Action
Touchscreen displays upside down	
Fan noisy or fan not working.	See “Cooling fan service check” on page 2-37.
Fuser parts melted.	See “LVPS/HVPS service check” on page 2-39.
Toner not fused to the media.	See “Fuser service check” on page 2-39 or “Solving print quality problems” on page 2-51.
Paper jams.	See “Paper feed service checks” on page 2-43.
Main motor noisy or not moving.	See “Main motor service check” on page 2-40.
Media skew.	See “Paper feed service checks” on page 2-43.
Printer not communicating with host.	See “USB port service check” on page 2-46.
Front access door will not close.	See “Cover interlock switch service check” on page 2-37.
Operator panel button not responding.	See “Operator panel service check” on page 2-43.
Operator panel lights are off or very dim.	See “Operator panel service check” on page 2-43.
Blank page.	See “Blank page” on page 2-47.
Black page.	See “Black page” on page 2-48.
Heavy background.	See “Heavy background” on page 2-48.
Light print.	See “Light print” on page 2-50.
White or black lines or bands.	See “White or black lines or bands” on page 2-50.
Toner on back of page.	See “Toner on back of page” on page 2-50.
Media never picks.	See “Media never picks” on page 2-44.
Media feeds continuously.	See “Media occasionally mispicks or picks multiple sheets at once” on page 2-44.
Media wrinkled or bent.	See “Media “trees,” wrinkles, stacks poorly, or curls” on page 2-45.
Dead machine (no power).	See “Dead machine service check” on page 2-38.
Print quality problems <ul style="list-style-type: none"> • Light print • Blurred characters • Toner on both sides of media • Toner not fused • Streaks • Blank pages 	See “Solving print quality problems” on page 2-51.

Scan / fax / copy symptom table





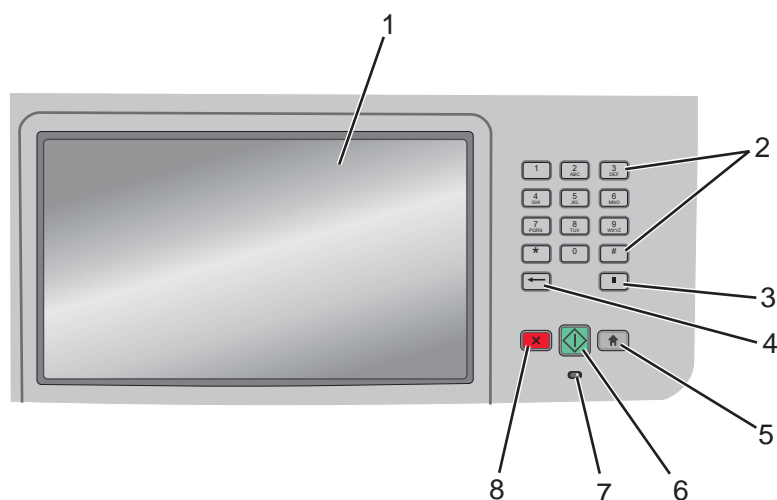

Symptom	Action
840.xx scanner error	Go to "840.xx service check" on page 2-55.
ADF won't duplex (Duplex ADF only)	Go to "ADF Duplex service check" on page 2-62.
ADF skew	Go to "ADF feed errors service check" on page 2-60.
Multiple pages feed into ADF	
Documents wont feed into ADF	
Printer picks letter size paper on a legal size scan	This is a symptom of a failed paper legnth sensor.
Scanner makes buzzing noise on startup or during a scan.	Go to "Flatbed home position service check" on page 2-58.
Document feeds, but jams in ADF.	Go to "ADF paper jam service check" on page 2-60.
Black streaks on scans	Go to "ADF streak service check" on page 2-59.
Blank page	Go to "Black or blank page copy service check" on page 2-57.
Black page	
No dial tone	Go to "Modem / fax card service check" on page 2-63.
Machine dials a number but fails to make a connection with another fax machine.	The other fax machine may be turned off. Ask the fax recipient to check their machine.
Incoming fax has blank spaces or poor quality.	<ol style="list-style-type: none"> 1. The sending fax machine may be faulty. 2. The sending fax machine may have a dirty document glass. 3. A noisy phone line can cause errors. 4. Check the MFP print quality by making a copy. 5. The print cartridge may be empty. Replace as necessary.
Invalid fax partition, or fax partition too small.	See Go to "Format Fax Storage" on page 3-7.
Some words on an incoming fax are stretched.	The sending fax machine had a temporary jam.
Faxes fail to transmit.	Go to "Fax transmission service check" on page 2-64.
Fax reception fails.	Go to "Fax reception service check" on page 2-66.

Overview of the operator panel and menus



The use of the buttons and the layout of the display panel are described in the following table.

Item		Description
1	Display	View scanning, copying, faxing, and printing options as well as status and error messages.
2	Keypad	Enter numbers or symbols on the display.
3	Dial Pause	<ul style="list-style-type: none"> Press to cause a two- or three-second dial pause in a fax number. In the Fax To field, a Dial Pause is represented by a comma (,). From the home screen, press to redial a fax number. The button functions only within the Fax menu or with fax functions. When outside of the Fax menu, fax function, or home screen, pressing causes an error beep.
4	Back	<p>In the Copy menu, press to delete the right-most digit of the value in the Copy Count. The default value of 1 appears if the entire number is deleted by pressing numerous times.</p> <p>In the Fax Destination List, press to delete the right-most digit of a number entered manually. You can also press to delete an entire shortcut entry. Once an entire line is deleted, another press of causes the cursor to move up one line.</p> <p>In the E-mail Destination List, press to delete the character to the left of the cursor. If the character is in a shortcut, then the shortcut is deleted.</p>

Item		Description
5	Home 	Press  to return to the home screen.
6	Start 	<ul style="list-style-type: none"> • Press  to initiate the current job indicated on the display. • From the home screen, press  to start a copy job with the default settings. • If pressed while a job is scanning, the button has no effect.
7	Indicator light	<p>Indicates the printer status:</p> <ul style="list-style-type: none"> • Off—The power is off. • Blinking green—The printer is warming up, processing data, or printing. • Solid green—The printer is on, but idle. • Blinking red—Operator intervention is needed.
8	Stop 	<p>Stops all printer activity</p> <p>A list of options is offered once Stopped appears on the display.</p>

Understanding the home screen

After the printer is turned on and a short warm-up period occurs, the display shows the following basic screen which is referred to as the home screen. Use the home screen buttons to initiate an action such as copying, faxing, or scanning; to open the menu screen; or to respond to messages.

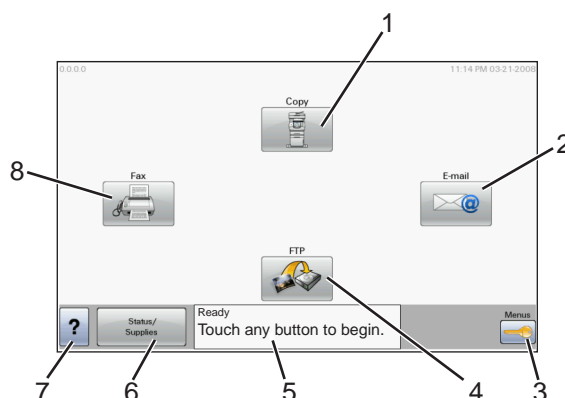

Display item		Description
1	Copy	Opens the Copy menu Note: From the home screen, you can also access the Copy menu by pressing a number on the keypad.
2	E-mail	Opens the E-mail menu
3	Menus	Opens the menus These menus are available only when the printer is in the Ready state.
4	FTP	Opens the File Transfer Protocol (FTP) menu Note: This function must be set up by your system support person. Once it is set up, it appears as a display item.
5	Status message bar	<ul style="list-style-type: none"> Shows the current printer status such as Ready or Busy. Shows printer conditions such as Toner Low. Shows intervention messages to give instructions on what you should do so the printer can continue processing, such as Close door or Insert print cartridge.
6	Status/Supplies	Appears on the display whenever the printer status includes a message requiring intervention. Touch it to access the messages screen for more information on the message, including how to clear it.
7	Tips	All menus have a Tips button. Tips is a context-sensitive Help feature within the display touch screens.
8	Fax	Opens the Fax menu

Other buttons that may appear on the home screen:

Display item	Description
Release Held Faxes	If this button is shown, then there are held faxes with a scheduled hold time previously set. To access the list of held faxes, touch this button.
Search Held Jobs	Searches on any of the following items and returns search results: <ul style="list-style-type: none"> User names for held or confidential print jobs Job names for held jobs, excluding confidential print jobs Profile names Bookmark container or job names USB container or job names for supported extensions only





Display item	Description
<p>Held Jobs</p> <p>Lock Device</p> <p>Unlock Device</p> <p>Cancel Jobs</p>	<p>Opens a screen containing all the held jobs</p> <p>This button appears on the screen when the printer is unlocked and Device Lock-out Personal Identification Number (PIN) has been set. Touching this button opens a PIN entry screen. Entering the correct PIN locks the printer control panel (touch screen and hard buttons).</p> <p>This button appears on the screen when the printer is locked. The printer control panel buttons and shortcuts cannot be used while it appears. Touching this button opens a PIN entry screen. Entering the correct PIN unlocks the printer control panel (touch screen and hard buttons).</p> <p>Opens the Cancel Jobs screen. The Cancel Jobs screen shows three headings: Print, Fax, and Network.</p> <p>The following items are available under the Print, Fax, and Network headings:</p> <ul style="list-style-type: none"> • Print job • Copy job • Fax profile • FTP • E-mail send <p>Each heading has a list of jobs shown in a column under it which can show only three jobs per screen. Each job appears as a button which you can touch to access information about the job. If more than three jobs exist in a column, then an arrow appears enabling you to scroll through the jobs.</p>

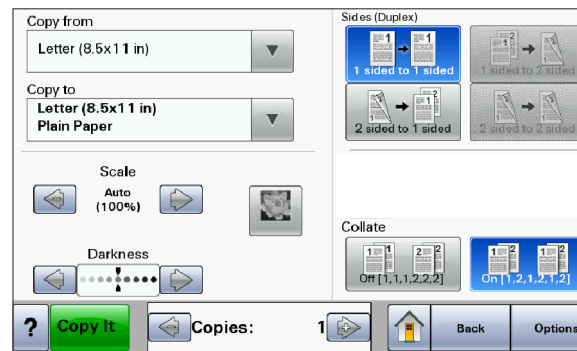

Using the touch-screen buttons

Note: Depending on your options and administrative setup, your screens and buttons may vary from those shown.



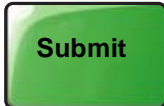

Sample touch screen



Button	Function
Home 	Returns to the home screen
Scroll down 	Opens a drop-down list
Left scroll decrease 	Scrolls to another value in decreasing order
Right scroll increase 	Scrolls to another value in increasing order
Left arrow 	Scrolls left

Button	Function
Right arrow 	Scrolls right
Submit 	Saves a value as the new user default setting
Back 	Navigates back to the previous screen

Other touch-screen buttons

Button	Function
Down arrow 	Moves down to the next screen
Up arrow 	Moves up to the next screen
Unselected radio button 	This is an unselected radio button. The radio button is gray to show it is unselected.
Selected radio button 	This is a selected radio button. The radio button is blue to show it is selected.





Button	Function
<p>Cancel Jobs</p> 	<p>Opens the Cancel Jobs screen. The Cancel Jobs screen shows three headings: Print, Fax, and Network.</p> <p>The following items are available under the Print, Fax, and Network headings:</p> <ul style="list-style-type: none"> • Print job • Copy job • Fax profile • FTP • E-mail send <p>Each heading has a list of jobs shown in a column under it which can show only three jobs per screen. Each job appears as a button which you can touch to access information about the job. If more than three jobs exist in a column, then an arrow appears enabling you to scroll through the jobs.</p>
<p>Continue</p> 	<p>Touch this button when more changes need to be made for a job or after clearing a paper jam.</p>
<p>Cancel</p> 	<ul style="list-style-type: none"> • Cancels an action or a selection • Cancels out of a screen and returns to the previous screen
<p>Select</p> 	<p>Selects a menu or menu item</p>

Diagram of the printer menus

The diagram shows the menu index on the operator panel and the menus and items available under each menu. Not all menus or selections will be available in all situations. These are accessed through the driver.

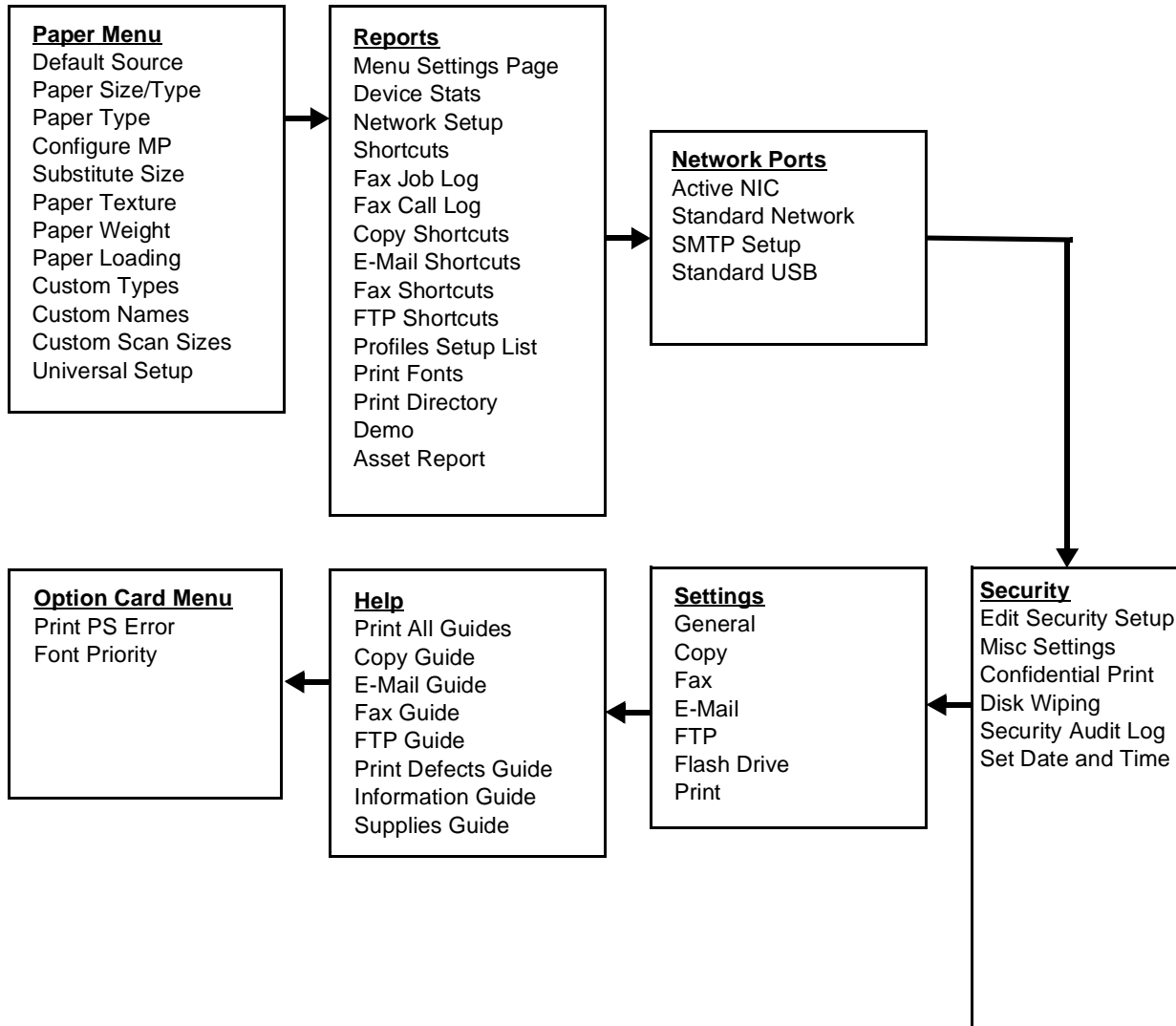

Messages and error codes

User attendance messages

The printer control panel displays messages describing the current state of the printer and indicates possible printer problems that must be resolved. This topic provides a list of all printer messages, explains what they mean, and tells how to clear the messages.

The following table lists the messages in alphanumerical order. A message can also be located using the index.

User status and attendance messages

User primary message	Explanation
Change <src><Custom type name>	<p>This IR allows a user to override the source for the remainder of a job. The page will be printed as it is formatted on the paper installed in the tray. This may cause clipping. No further Change prompts will be posted for the remainder of the current job.</p> <p>The following actions can be taken:</p> <ul style="list-style-type: none"> • Change the paper source to a custom type / custome string /source and size/ source, type, size. • Continue the print job. • Request more information. • Use the current source. • Reset the active. • Wait fir supplies.
Change <src><Custom String>	
Change <src><size>	
Change <src><type><size>	
Close Door	Message clears when front doors is closed.
Disk Corrupted. Reformat?	This message appears if there is a corrupted hard disk. Reformat the drive. If the message remains, replace the disk.
Weblink server not setup. Contact system administrator	<p>Web Link is being used for e-mail, and either the 'Server' or 'Web Link' fields are NULL in the Web Link Setup.</p> <ul style="list-style-type: none"> • The system administrator needs to configure the server.
SMTP server not setup. Contact system administrator	The devices primary and secondary SMTP fields are blank. This needs to be configured by the system administrator.
No Analog Phone Line	An analog line is not detected as being plugged into the modem. If the device is in Analog mode, this has a source of Fax. If the device is in Fax Server mode, and the 'Enable analog receive' Fax Server setting is set to 'On', this has a source of Fax Receive. If the device is in Fax Server mode and the 'Enable analog receive' Fax Server setting is set to 'Off', then this IR is not generated.
Memory Full, cannot print faxes	Attempted print is automatically canceled. The Fax code will recognize that the print job has been canceled and will not delete pages in the fax job that have not printed. Fax will not attempt to reprint the fax that generated the out of memory error until a POR is performed.
Memory Full, cannot send faxes	After a start, there is no memory to do the fax job. Attempted fax is cancelled.
Fax server 'To Format' not set up	Device is in Fax Server mode. The To format for the Fax Server setup is null. Analog receive still possible.
Fax Station number not set up.	
Held jobs may not be restored	This message is only posted once after the firmware has tried to restore all of the jobs on disk, regardless of the number of held jobs that were not restored. There are three versions of this IR, depending upon cause. IRHeldA occurs when any other condition occurs which stops the printer from restoring jobs from disk. These might include disk failure, user abort, etc.







User status and attendance messages (Continued)

User primary message	Explanation
Held jobs may not be restored (Insufficient Memory 37)	This message is only posted once after the firmware has tried to restore all of the jobs on disk, regardless of the number of held jobs that were not restored. There are three versions of this IR, depending upon cause. IRHeldB occurs when the printer runs out of memory while attempting to restore jobs from disk.
Held jobs may not be restored (Config Change 57)	This message is only posted once after the firmware has tried to restore all of the jobs on disk, regardless of the number of held jobs that were not restored. There are three versions of this IR, depending upon cause. IRHeldC occurs when the printer could not restore jobs from the disk because the configuration of the printer has changed. Some of these said configuration changes are code version changes, paper handling option(s) removed, or the disk was moved from a different model or speed of printer.
Load <source> <custom string>	Printer does not detect media meeting the description <custom string> in <source>, where <source> is Tray 1, Tray 2, Multi-Page Feeder (MP feeder), or Envelope Feeder. <ul style="list-style-type: none"> • Load the input source with the correct type and size media. • Cancel the current job.
Load <source> <custom type>	Printer does not detect media meeting the description <custom type> in <source>, where <source> is Tray 1 or Tray 2. <ul style="list-style-type: none"> • Load the input source with the correct type and size media. • Cancel the current job.
Load <source> <size>	Printer does not detect media meeting the size requested in the source indicated. <ul style="list-style-type: none"> • Load the input source with the correct type and size media. • Cancel the current job.
Load <source> <type> <size>	Printer does not detect media meeting the size or type requested in the source indicated. <ul style="list-style-type: none"> • Load the input source with the correct type and size media. • Cancel the current job.
Load Manual <custom type>	Printer does not detect media meeting the description <custom type> in the single sheet feeder (manual feeder). The following actions can be taken: <ul style="list-style-type: none"> • Load paper, and the job continues. • press Select (<input checked="" type="checkbox"/>), and choose an alternate source for media. • Cancel the current job.
Load Manual <custom string>	Printer does not detect media meeting the description <custom string> in the single sheet feeder (manual feeder). The following actions can be taken: <ul style="list-style-type: none"> • Load paper and the job continues. • press Select (<input checked="" type="checkbox"/>), and choose an alternate source for media. • Cancel the current job.
Load Manual <size>	Printer does not detect media meeting the description <size> in the single sheet feeder (manual feeder). The following actions can be taken: <ul style="list-style-type: none"> • Load paper and the job continues. • press Select (<input checked="" type="checkbox"/>), and choose an alternate source for media. • Cancel the current job.









User status and attendance messages (Continued)

User primary message	Explanation
Load Manual <type> <size>	Printer does not detect media meeting the description <type> and <size> in the single sheet feeder (manual feeder). The following actions can be taken: <ul style="list-style-type: none"> • Load paper and the job continues. • press Select (<input type="checkbox"/>), and choose an alternate source for media. • Cancel the current job.
Paper Changes Needed	Change or load new media.
PJL OP Message	
PJL Seed Message	
PJL ST Message	Try one or more of the following: <ul style="list-style-type: none"> • press Select (<input type="checkbox"/>) to clear the message, and continue printing. • Wait for the message to clear.
Remove Paper ADF	This posts when there is paper detected in the ADF upon POR or when the cover is closed (or any other situation that re-inits the scanner). Message clears when paper is removed.
Remove Paper Standard Bin	The standard output bin is full or nearly full. Remove the media from the bin.
Restore Held Jobs. Go/ Stop?	Held jobs were found on disk after a power on/off reset. Restoring will make these jobs available. Jobs may also be restored at a later time by turning off and restarting the printer. The following actions can be taken: <ul style="list-style-type: none"> • Restore • Do not restore • More information
Securely Clearing Disk Space	This message appears when all blocks of the disk are cleared.
Unsupported USB Device, Please Remove	Remove the unrecognized device from the USB port on the front of the printer.
Unsupported USB Hub, please remove	Remove the unrecognized USB hub/device from the USB port on the front of the printer.
Unsupported Disk	Remove the unsupported disk before continuing.
34 Short Paper	<ul style="list-style-type: none"> • press Select (<input type="checkbox"/>) to clear the message and continue printing. The printer does not automatically reprint the page that prompted the message. • Check tray length and width guides to ensure paper is properly fitted in the tray. • Make sure the print job is requesting the correct size of paper. • Adjust the Paper Size setting for the size paper you are using. If MP Feeder Size is set to Universal, make sure the paper is large enough for the formatted data. • Cancel the current job.

User status and attendance messages (Continued)

User primary message	Explanation
35 RES Save Off Deficient Memory	<p>This message displays when the printer lacks sufficient memory to enable Resource Save. This message usually indicates the user has allocated too much memory for one or more of the printer link buffers; however, modification of other printer settings which affect the amount of available memory may also create this condition. If restoration of Resource Save is required after this message is received, the customer should install additional memory or set each link buffer to Auto. Once all link buffers are returned to Auto, you should exit the menu to activate the link buffer changes. Once the printer returns to the Ready state, you can enable Resource Save and go back and modify the link buffers again. Note the reduction of available memory to the link buffers when Resource Save has been enabled, and compare it to the memory available when Resource Save is disabled.</p> <ul style="list-style-type: none"> • press Select () to disable Resource Save and continue printing. To enable Resource Save after you get this message: <ul style="list-style-type: none"> - Make sure the link buffers are set to Auto, then exit the menus to activate the link buffer changes. - When Ready is displayed, enable Resource Save. • Install additional memory.
37 Insufficient Collation Area	<p>This message is displayed when the printer memory used to store pages is too full to collate the print job.</p> <p>The following actions can be taken:</p> <ul style="list-style-type: none"> • press Select () to print the portion of the job already stored, and begin collating the rest of the job. • press Menus () to access the Busy/Waiting Menu. The following functions are available. <ul style="list-style-type: none"> - Cancel Job <p>Note: Menu Lockout does NOT prevent access to the Busy/Waiting Menu.</p>
37 Insufficient memory for flash defragment operation	<p>This message is displayed when insufficient printer memory is available to perform Flash Memory Defragment operation.</p> <p>This message appears prior to the actual start of the defragment operation.</p> <p>press Select () to stop the defragment operation.</p> <p>To perform the defragment operation, you can:</p> <ul style="list-style-type: none"> • Delete fonts, macros, and other data in RAM. • Install additional printer memory. • press Menus () to access the Busy/Waiting Menu. The following functions are available using the Busy/Waiting Menu: <ul style="list-style-type: none"> - Cancel Job - Reset Printer <p>Note: Menu Lockout does NOT prevent access to the Busy/Waiting Menu.</p>
38 Memory Full	<p>This message is displayed when the printer is processing an incoming job and there is not enough memory available to continue processing the job.</p> <p>The following actions can be taken:</p> <ul style="list-style-type: none"> • Determine how to make more memory available to your print job by: <ul style="list-style-type: none"> - Deleting fonts, macros and other data in RAM. - Simplify your print job. - Install additional memory • press Select () to clear the message and continue printing. The job may not print correctly. • press Menus () to access the Busy/Waiting Menu. The following functions may be available: <ul style="list-style-type: none"> - Cancel Job

User status and attendance messages (Continued)

User primary message	Explanation
39 Complex Page	<p>This message is displayed when a page is too complex to print.</p> <p>The following actions can be taken:</p> <ul style="list-style-type: none"> • press Select () to clear the message and continue printing. The job may not print correctly. • Simplify the print job. • press Menus () to access the Busy/Waiting Menu. The following functions may be available: <ul style="list-style-type: none"> - Cancel Job - Reset Printer <p>Note: Menu Lockout does NOT prevent access to the Busy/Waiting Menu.</p>
50 PPDS Font Error	<p>This error only occurs when a printer is formatting PPDS print data.</p> <p>The PPDS interpreter has detected a font error. When a specific font, which is not installed, is requested based on a PPDS mode Set Font Global command, a Select Code Page command, or a Comprehensive Font Selection command, and the printer Best Fit setting is off. If Best Fit is on, the printer performs a best fit search to find a similar font, and this error does not occur.</p> <p>This error also displays when the printer receives invalid PPDS download font data.</p> <p>The following actions can be taken while this message is displayed:</p> <ul style="list-style-type: none"> • press Select () to clear the message and continue printing. The job may not print correctly. • press Menus () to access the Busy/Waiting Menu. The following functions may be available: <ul style="list-style-type: none"> - Cancel Job
51 Defective Flash Detected	<p>press Select () to clear the message and continue printing.</p> <p>You must install different flash memory before you can download any resources to flash.</p>
52 Flash Full	<ul style="list-style-type: none"> • press Select () to clear the message and continue printing. • Delete fonts, macros, and other data stored on the flash memory. • Install a larger capacity flash memory card.
53 Unformatted Flash	<p>press Select () to clear the message and continue printing.</p> <p>You must format the flash memory before you can store any resources on it. If the error message remains, the flash memory may be defective and require replacing.</p>
54 Standard Network Software Error	<p>This message is displayed when the RIP software detects that a network port is installed but cannot establish communications with it.</p> <ul style="list-style-type: none"> • press Select () to clear the message and continue printing. The job may not print correctly. • Program new firmware for the network interface. • Turn the printer power off and then back on to reset the printer.
54 Network <x> Software Error	<p>The printer disables all communications to the associated network interface. No data may be received or sent from or to the associated interface. The user can program new firmware in the network using the parallel port after this message clears.</p> <ul style="list-style-type: none"> • press Select () to clear the message and continue printing. The job may not print correctly. • Program new firmware for the network interface. • Turn the printer power off and then back on to reset the printer.
55 Unsupported Option in Slot <x>	<p>An unsupported option is installed in the specified solutions port. Power off the printer and remove the unsupported option in the specified slot.</p> <p>Remove the unsupported option.</p>
56 Parallel Port <x> disabled	<p>This error displays when data is sent to the printer across an optional parallel port, but the port has been disabled. Once this message displays, reporting of further errors is suppressed until the menus are entered, or the printer is reset.</p>

User status and attendance messages (Continued)

User primary message	Explanation
56 Serial Port <x> disabled	This error displays when data is sent to the printer across an serial port, but the port has been disabled. Once this message displays, reporting of further errors is suppressed until the menus are entered, or the printer is reset.
56 Standard USB Port Disabled	<p>This message may appear when data is sent to the printer across a USB port, but the port is disabled.</p> <p>Note: Once the error is displayed the first time, reporting of further errors is suppressed until the printer is reset or menus are entered.</p> <p>The following actions can be taken:</p> <ul style="list-style-type: none"> • press Select (✓) to clear the message. Any data received on the USB port is discarded. • press Menus (ⓘ) to access the Busy/Waiting Menu. The following functions may be available: <ul style="list-style-type: none"> - Turn the printer power off and then back on to reset the printer. - Reset Active Bin - Check Supply Levels <p>Make sure the USB Buffer menu item is not set to Disabled. (press Menus ⓘ to access the Administrative Menus, select Network/Ports, USB Menu, and USB Buffer.)</p>
58 Too many Flash Options Installed	<ol style="list-style-type: none"> 1. Turn off and unplug the printer. 2. Remove the excess flash memory. 3. Plug in the printer, and turn it on.
58 Too Many Trays Attached	<ol style="list-style-type: none"> 1. Turn off and unplug the printer. 2. Remove the additional trays. 3. Plug in the printer, and turn it on.
59 Incompatible Tray <x>	<p>An incompatible tray is installed. For Tray x, x= 2, 3, 4, or 5.</p> <p>Remove the incompatible tray and press (✓) to clear the message.</p> <p>If the user installed the incompatible device to satisfy a Check Device Connections/reattach message, the user should reinstall an associated compatible option or hot unplug the option.</p> <ol style="list-style-type: none"> 1. Turn off and unplug the printer. 2. Remove the incompatible trays. 3. Plug in the printer, and turn it on.
61 Defective Disk	<p>This error code displays when the printer detects a defective disk. This error may occur at power on or during disk format and write operations. While this message displays.</p> <p>Press (✓) to clear the message. The disk is marked defective and normal printer operations continue. Disk operations are not allowed with a defective disk. The Format Disk menu is not shown.</p>
62 Disk Full	This error code displays when there is not enough free space on the disk to hold the resources that have been requested to be written to the disk. This message displays for both resource and PostScript Disk operators when the disk is full.
63 Unformatted Disk	<p>The optional disk is not formatted.</p> <p>Format the disk. If the error remains after formatting, the disk may be defective.</p>
80 Routine Maintenance	The operator panel displays this message at each 300K page count interval. It is necessary to replace the fuser assembly, transfer roller, charge roll, and pick rolls at this interval to maintain the print quality and reliability of the printer. The parts are available as a maintenance kit. See “Maintenance kits” on page 6-1 .
84 PC Kit Life Warning	Replace the PC kit to ensure print quality.
84 Replace PC Kit	
88 Cartridge Low	This warning is displayed when the cartridge is low. Press Check to continue.
88 Cartridge Early Life Warning	

User status and attendance messages (Continued)

User primary message	Explanation
1565 Emul Error Load Emul Option	<p>This message is displayed when the DLE's version contained in the firmware card will not function with the printer code. The message will automatically clear in 30 seconds, and the DLE will be disabled. Other printer functions are not affected.</p> <p>The correct version of the DLE must be downloaded. Contact the second level support for the correct DLE version.</p>
Scanner ADF cover open	<p>The cover to the ADF is open.</p> <ul style="list-style-type: none"> • Close the ADF cover. If this doesn't remedy the problem, Go to “ADF cover open service check” on page 2-59.
Scan job too long	<p>The scan job exceeds the maximum number of pages</p> <ul style="list-style-type: none"> • Break the scan job into multiple small jobs. • Cancel the scan job.
Scan Paper cleared	<p>Paper is cleared from ADF</p> <ul style="list-style-type: none"> • Cancel job • Restart job - This can only be performed if job recovery is enabled and the job can be restarted. A new job with the same parameters is started.

Cartridge error messages

Error	Description	Action
30	Invalid refill	Replace the cartridge.
31	Missing or defective cartridge	
32	Unsupported print cartridge	

Paper jam error codes (200-series)

Note: The Event log (See **“EVENT LOG”** on page 3-32) will list any of these errors that have occurred.

Repeating jams or jam messages can be caused by any of the following:

- Faulty/contaminated pick solenoids or worn cams of the solenoids.
- Faulty/contaminated flags or springs.
- Debris in the paper path.
- Media not of the specified length.
- Faulty media feed clutch. See **“Media feed clutch service check”** on page 2-40.

Error	Description	Action
200.00	Paper jam around input sensor.	Remove the PC kit and paper or debris at the input sensor.
200.01	Classic input jam. The media is too long over the input sensor. Possible causes include multi-sheet feed, tray size sensing problem, and media slippage.	First, remove the PC kit and paper or debris at the input sensor. Then, inspect the flag on the input sensor. It should rotate freely. Replace the sensor if necessary. Finally, check the paper size settings in the printer and the driver.
200.02	The main input sensor never became uncovered from the sheet ahead.	
200.03	The video never started on the page at the input sensor within two inches after hitting the input sensor	Check the printhead. See “Printhead service check” on page 2-54.
200.04	The media at the input sensor before interrupt occurred—not enough time elapsed since the printhead started to expect the printhead mirror motor lock. Possible causes include bouncy sensor or exceptionally fast pick—perhaps due to media pre-staged in the source tray.	Carefully remove the tray and notice if the leading edge of the media is pointed upward and out of the tray. If so, then inspect the tray wear strips and replace if necessary. Inspect the input sensor flag and replace it if it does not rotate freely or is too loose.
200.06	Imaged page not expected page (bouncy passthru sensor)	Remove the toner cartridge/PC kit. At the front, remove the upper front guide, and inspect the flag on the manual input sensor. If the flag is loose, then replace it. See “Media manual input sensor” on page 2-54.
200.08	Media reached the input sensor before the EP was ready	Inspect the tray for prestaging. Verify the proper media and inspect the tray wear strips. Replace the wear strips if necessary.
200.09	Transfer servo never started	Inspect the LVPS/HVPS. See “Engine board service check” on page 2-36.

Error	Description	Action
200.12	Media detected at manual feeder sensor when not expected. Possible causes include user insert of media when motor is running or pre-staged media in the tray.	Carefully remove the tray and notice if the leading edge of the media is pointed upward and out of the tray. If so, then inspect the tray wear strips and replace if necessary. Inspect the input sensor flag and replace it if it does not rotate freely or is too loose.
200.13	The input sensor is covered when the media is not expected (media in machine during warm-up)	Remove the toner cartridge/PC kit and inspect the input sensor flag. Replace the flag if necessary.
200.14	Trailing edge cleared manual feed, but did not successfully debounce the sensor. Potential causes are a small gap or a bouncy manual feed sensor.	Remove the toner cartridge/PC kit. At the front, remove the upper front guide, and inspect the flag on the manual input sensor. If the flag is loose, then replace it. See “Media manual input sensor” on page 2-54.
200.15	UNRECOVERABLE NO GAP JAM. Engine detected no gap at the manual feeder sensor, attempted to open the gap by stopping the feed rolls, but no trailing edge was ever seen at the input sensor.	Remove the toner cartridge/PC kit. At the front, remove the upper front guide, and inspect the flag on the manual input sensor. If the flag is loose, then replace it. See “Media manual input sensor” on page 2-54. Verify that the media is approved. Inspect the wear strips in the input tray, and replace if necessary.
200.16	Transport motor error detected	Inspect the main motor. See “Main motor service check” on page 2-40.
200.17	Took too long to ramp up transport motor	
200.18	Manual feeder sensor never became uncovered from the sheet ahead.	Remove the toner cartridge/PC kit. At the front, remove the upper front guide, and inspect the flag on the manual input sensor. If the flag is loose, then replace it. See “Media manual input sensor” on page 2-54.
200.19	The media never reached the input sensor, but was detected at manual feeder sensor.	Remove the toner cartridge/PC kit, and inspect for debris in the paper path. Check the bottom of the PC kit for any obstructions. Remove the upper front guide, and inspect the pinch rollers.
200.20	The media is too long over the manual feeder sensor. Possible causes include multi-sheet feed, media size (length) problem, pre-staged media in the tray.	Verify that the media is approved. Inspect the wear strips in the tray, and replace if they are worn.
200.22	FAILED SMALL GAP OR NO GAP JAM RECOVERY. Engine detected small gap or no gap at the manual feeder sensor, opened the gap by stopping the feed rolls, but never saw the leading edge of the second page at the input sensor.	
200.23	Laser Servo never started due to potential conflict with the transfer servo. Possible causes: slow or missing transport motor positional feedback, or the media is transferred too quickly to the input sensor.	Verify that the media is approved. Inspect the wear strips in the tray, and replace if they are worn. Check the main motor. See “Main motor service check” on page 2-40.
200.24	The measured gap at the input sensor is too small to meet the video delivery requirements. (There is not enough time since prior image finished to start new image)	Verify that the media is approved. Inspect the wear strips in the tray, and replace if they are worn.
200.26	The trailing edge never cleared the input sensor when feeding out the media that was detected during warm-up.	

Error	Description	Action
200.27	<p>Printhead Driver: Mirror motor fell out of lock condition after the media at the input sensor—more time elapsed since the printhead than the expected stable lock time, but less than the printhead jitter-stable specification.</p> <p>Mirror motor fell out of lock condition after media at the input sensor—more time elapsed since the printhead than expected stable lock time, but less than the printhead jitter-stable specification.</p>	Check the printhead. See “Printhead service check” on page 2-54.
200.28	First writing line of a page at the developer nip, but laser servo cleanup is not complete. Likely pre staged media or a fast paper feed.	Verify that the media is approved. Inspect the wear strips in the tray, and replace if they are worn.
200.29	Printhead drive control out of range due to an external event beyond what the control is designed to handle. Probable causes: ESD or noise on hsync signal.	Check the cable routing for the printhead. See “Printhead service check” on page 2-54.
200.30	Narrow media sensor covered during warm-up.	Check that the narrow media flag rotates freely and securely. If it is dislodged or broken, then repalce the rear exit guide. See “Rear exit guide assembly with sensor and reversing solenoid removal” on page 4-78.
200.32	Media more than 14 inches too long over the manual feeder sensor. Possible causes include multi-sheet feed or pre-staged media in the tray.	Verify that the media is approved. Inspect the wear strips in the tray, and replace if they are worn.
200.33	Page from tray 1 did not reach the input sensor after multiple attempts. Page did make it out of the tray at least as far as the manual feeder sensor. Possible cause is that the page stalled at the alignment gate.	Verify that the pick tires are clean, not worn, or filled with paper dust. Replace the pick tires if necessary. See “ACM pick tire roller removal” on page 4-3.
200.34	Timed out waiting for page from tray 1 to reach the input sensor after multiple pick attempts, but the page was later detected at the input sensor while waiting for any page(s) ahead to clear the paper path. Possible cause is that the page is delayed at the alignment gate.	The alignment roller may be binding. Call the next level of support.
200.35	Failed to create hsync during auto alignment	Check the printhead. See “Printhead service check” on page 2-54.
200.36	Lost hsyncs during auto alignment	
200.37	Timeout on data collection during auto alignment	
200.38	Interpage servo gap is smaller than expected for printhead offset target evaluation	
200.42	Rogue sheet is at the manual feed sensor while flushing the paper path prior to declaring MPF source empty.	Retry alignment.
200.43	The media is at the input sensor before interruption occurs. Possible causes include bouncy sensor or an exceptionally small gap, perhaps due to the media being pre-staged in the source tray.	Remove the media, realign the stock, and re-insert. Do not let the top sheets to go beyond the wear strips.
201.00	Paper jam between input and exit sensor	Remove the toner cartridge/PC kit and check for obstructions between the input sensor and the fuser. if the media continues to stop at the entrance or in the fuser, then replace the fuser. See “Fuser removal” on page 4-28.
201.01	Transport motor identification failed to identify either motor after two tries.	Check the main motor. See “Main motor service check” on page 2-40.

Error	Description	Action
201.02	Exit sensor never made by leading edge of page. Also known as internal jam.	Remove the PC kit and paper or debris at the input sensor.
201.03	Video never started on the page at the input sensor within two inches after hitting the input sensor	Check the printhead. See “Printhead service check” on page 2-54.
201.05	Restart attempted after an internal jam without the cover open/close event. It is likely that the jam was never cleared.	Check the paper path and remove any media in the path.
201.25	Exit sensor never made by leading edge of media when feeding out the media that was detected during warm-up.	Remove the toner cartridge/PC kit and check for obstructions between the input sensor and the fuser. If the media continues to stop at the entrance or in the fuser, then replace the fuser. See “Fuser removal” on page 4-28.
201.26	Page at fuser nip before fuser started ramping toward desired temperature. Indicates code may be receiving more interrupts than intended	
201.27	Page at fuser nip before fuser reached acceptable operating temperature. Page arrived at fuser earlier than expected, so it was probably staged prematurely.	
202.00	Paper jam around exit sensor.	Open the rear cover and look for obstructions in the path way. If there are none, then inspect for damage at the fuser, rear door, exit guide, and top cover. Often, the leading edge of the media will indicate the vicinity of damage. If damage is found, then replace the damaged part. Note: Print a page with the rear door open to isolate the fuser from the other parts.
202.01	Exit sensor never broke on the trailing edge of the sheet at the exit sensor.	Open the rear door, and inspect the flag on the exit sensor. The flag is located behind the fuser exit rollers, about mid printer. If the flag does not rotate freely or has no spring action, then replace the fuser. See “Fuser removal” on page 4-28.
202.02	Exit sensor never broke from sheet ahead of page heading toward the exit sensor.	
202.06	Exit sensor bounced	
202.13	Exit sensor covered, media not expected (media not in machine during warm-up)	
202.25	Exit sensor never broke from the sheet ahead of the page heading toward the exit sensor when feeding out the media detected during warm-up.	
202.26	Trailing edge never cleared exit sensor when feeding out media that was detected during warm-up.	Open the rear door, and inspect the flag on the exit sensor. The flag is located behind the fuser exit rollers, about mid printer. If the flag does not rotate freely or has no spring action, then replace the fuser. See “Fuser removal” on page 4-28.
202.32	Long media or shingled multi feed stopped before sending to duplex.	Check the paper setting and correct if needed. While feeding along the media, and immediately after it enters the output bin, open the rear door and obscure the trailing edge and the sensor flag. If there is slippage in the exit guide, then replace the exit guide. See Go to “Rear exit guide assembly with sensor and reversing solenoid removal” on page 4-78.

Error	Description	Action
231.00	Duplex jam while reversing into the device	<p>Open the rear cover and look for obstructions between the rear cover ribs, the fuser exit rollers, and below. The media entering the duplex passes outside the exit roller while the media exiting the fuser passes above and inside the exit rollers. Remove the tray, open the duplex door, and remove the obstructions. If there are no obstructions and the problem persists, then disconnect all of the cables, tilt the printer onto its back (be sure to protect the antenna on a wireless unit), and inspect the flag of the duplex sensor. If the flag does not rotate freely, then replace the paper input and duplex sensor. See “Paper input and duplex sensor assembly removal” on page 4-73.</p> <p>Check the belt and drive of the duplex unit. Replace it if necessary.</p>
231.01	Duplex sensor never made by leading edge reversing into the duplex.	
231.02	Bouncy duplex sensor never made.	
233.00	Duplex jam while picking from the device	
233.01	Page in duplex never picked.	
233.02	Feed error picking from the duplex.	
233.03	Paper never reached the input sensor, but was detected at the manual feed sensor.	
234.01	Duplex sensor covered during warm-up.	<p>Check the media. Duplex supports A4, letter, legal, oficio, and folio media sizes.</p>
235.01	Invalid duplex media (Unsupported size)	
241.00	Paper jam near tray 1.	<p>Remove the tray and inspect the media path for obstructions. Check the pick rollers. Replace the pick rollers if they are worn or clogged with dust. See “ACM pick tire roller removal” on page 4-3. Also check the wear strips, and replace if necessary.</p> <p>Remove the tray and inspect the media path for obstructions. Check the pick rollers. Replace the pick rollers if they are worn or clogged with dust. See “ACM pick tire roller removal” on page 4-3. Also check the wear strips and the manual feeder, and replace if necessary.</p>
241.10	Second pick attempt failed from Tray 1	
241.12	Second pick from manual feeder, tray 1, or feeder failed when the media was in the source while other sheets were committed to the paper path.	
241.16	Failed to feed from tray 1. Pages in the paper path have been flushed to the output bin.	
241.17	MISIDENTIFIED SMALL GAP JAM. Engine detected small gap at the manual feeder sensor, attempted to open the gap by stopping the feed rolls, trailing edge was seen at the input sensor, manual feeder sensor is no longer covered.	
241.19	Second pick attempted failed from Tray 1, no pages printed since calling a 241.10 or a prior 241.19.	
242.00	Paper jam near tray 2.	
242.01	Took too long to ramp up dc feed motor	<p>Check the connection with Tray 2. (Lift the printer and re-set it on Tray 2.) If the error persists, then replace Tray 2.</p>
242.08	Received lots of dc feed interrupts before losing them	
242.10	Second pick attempt failed from Tray 2	<p>Remove Tray 2 and inspect for obstruction in the paper path. Check the pick tires for wear or paper dust. Replace if necessary. Check the wear strips and replace if necessary.</p> <p>Check the wear strips and replace them if worn.</p> <p>Remove Tray 2 and inspect for obstruction in the paper path. Check the pick tires for wear or paper dust. Replace if necessary. Check the wear strips and replace if necessary.</p>
242.12	Second pick from manual feeder, tray 1, or feeder failed when media was in the source, other sheets were committed to the paper path.	
242.16	Failed to feed from tray 2. Pages in the paper path have been flushed to the output bin.	

Error	Description	Action
251.00	Paper jam near the manual feeder.	Inspect the pick roller on the MPF or the rollers on the manual feed. If the MPF pick roller is damaged or worn, then replace the MPF. For a printer with a manual feed only (no MPF), clean the roller.
251.10	Second pick attempt failed from manual feeder.	
251.11	Failed to feed from manual feeder. Pages in the paper path have been flushed to the output bin.	
251.12	Second pick from manual feeder, tray 1, or feeder failed when media was in the source while the other sheets were committed to the paper path.	
251.19	Media never reached the input sensor from the manual feeder.	
251.20	The media in the MPF has been pushed in too far.	Remove the media, realign the stock, and re-insert. Do not let the top sheets to go beyond the wear strips.
251.21	The media in the MPF has been pushed in too far.	
290.02	Scanner ADF Feed Jam. The scanner ADF has failed to feed a page to the ADF interval sensor.	Remove the sheet of paper from the ADF. Retry the job. If the error recurs, Go to “ADF paper jam service check” on page 2-60.
290.10	Scanner Static Jam - 1st scanner sensor. Scanner ADF detects paper at the first scanner sensor while the ADF is in an idle state.	Remove all paper from the ADF. Retry the job. If the error recurs, Go to “ADF paper jam service check” on page 2-60.
291.00	Scanner Static Jam - 2nd scanner sensor. Scanner ADF detects paper at thesecond scanner sensor while the ADF is in an idle state.	
292	Scanner jam, remove all originals from the scanner. This message appears if the ADF cover is open while paper is fed through the ADF.	Remove the paper from the ADF, and close the ADF cover. If the error recurs, Go to “ADF cover open service check” on page 2-59.
293.02	Flatbed cover open. The MFP senses that the flatbed cover is open.	Close the flatbed cover. See “ADF cover open service check” on page 2-59.
294.04	Scanner jam, remove all originals from the scanner. Jam at the ADF exit sensor.	294.06Remove all paper from the ADF. If the error recurs, “ADF paper jam service check” on page 2-60.
294.05	Scanner jam, remove all originals from the scanner. A jam is detected at the ADF exit sensor.	
294.06	ADF Backfeed Jam. A jam is detected at the ADF exit sensor.	
295.01	Scanner Disable Page at CCD	ADF page gap is too small. Not enough to re initialize the image processing unit. Remove paper from the ADF.
295.02	Scanner Disable Page at CCD	The ADF page gap is too small, not enough room to accelerate after pausing. Remove paper from the ADF.

Service error codes

Service error codes are generally non-recoverable except in an intermittent condition when the printer can be put into POR to temporarily recover from the error condition.

Error	Description	Action
8XX Scanner service errors		
840.01 Scanner disabled	The scanner is disabled and can't be used.	Enter the configuration menu, and re-enable the scanner module. Go to "840.xx service check" on page 2-55
840.02 Scanner auto disabled	The scanner is disabled and can't be used.	This message is posted when the MFP PORs. Enter the configuration menu, and re-enable the scanner module. Go to "840.xx service check" on page 2-55
841	Image Pipeline	Image pipeline ASIC. Go to "CCD service check" on page 2-57 . Also, Go to "Flatbed home position service check" on page 2-58 .
841.96	SIZAR out of band interrupt	
842	Communication Failure	Communication failure. Go to "CCD service check" on page 2-57
843	Scanner Failure - Carriage failed to move to Home of desired position	Carriage mechanical failure. Go to "Flatbed motor service check" on page 2-57
843.01	Scanner Failure	ADF mechanical failure. Go to "ADF paper jam service check" on page 2-60
843.02	Scanner Failure	General mechanical failure
843.03	Scanner Failure	Pick Roller engage failure
843.04	Scanner Failure	Pick roller disengage failure
844.yy	Scanner Failure	Lamp failure. Go to "CCD service check" on page 2-57
844	Front scan module output level error	Go to "CCD service check" on page 2-57
844.01	Rear scan module output level error	
844.02	Front scan module lamp level too low	Front Mono channel, Front Color channels, Front Red channel, Front Green channel, and/or Front Blue channel is detected to have low lamp level. Go to "CCD service check" on page 2-57
844.03	Rear scan module lamp level too low	Rear Mono channel, Rear Color channels, Rear Red channel, Rear Green channel, and/or Rear Blue channel is detected to have low lamp level. Go to "CCD service check" on page 2-57
845.yy	Scanner Failure	CCD failure Go to "CCD service check" on page 2-57
845	Front scan module cable failure or SCC card failure	CCD channel failure. Check each channel(mono, R, G, B) for identical values indicating bad cable and/or SCC card. Excessive noise test for the dark data indicating some sort of CCD or analog electronics issue on that channel or channels. Go to "CCD service check" on page 2-57

Error	Description	Action
845.01	Rear scan module cable failure or SCC card failure	<p>CCD channel failure. Check each channel(mono, R, G, B) for identical values indicating bad cable and/or SCC card. Excessive noise test for the dark data indicating some sort of CCD or analog electronics issue on that channel or channels.</p> <p>Go to “CCD service check” on page 2-57</p>
845.02	Cable / SCC Failure	<p>Front scan module connector or cable failure</p> <p>Go to “CCD service check” on page 2-57</p>
845.03	Cable / SCC Failure	<p>Rear scan module connector or cable failure</p> <p>Go to “CCD service check” on page 2-57</p>
845.yy	CCD Failure	<p>The CCD is defective.</p> <p>Go to “CCD service check” on page 2-57.</p>
846	Front calibration strip unusable	Go to “CCD service check” on page 2-57
846.01	Rear calibration strip unusable	
846.02	Front calibration strip too far left	The font calibration strip is placed to high or to low. Go to “CCD service check” on page 2-57
846.03	Front calibration strip too far right	Go to “CCD service check” on page 2-57.
846.04	Front calibration strip has excessive skew	
846.05	Front calibration strip has excessive bow	
846.06	Front calibration strip has excessive dark area	Front excessive variability for Mono, Red, Green, or Blue. Go to “CCD service check” on page 2-57
846.07	Front magnification exceeds limits	Rear excessive variability for Mono, Red, Green, or Blue. Go to “CCD service check” on page 2-57
847	Modem Failure	The Configuration ID bit that describes the device’s modem doesn’t match the actual modem installed in the device.
847.01	Fax Storage	The amount of flash storage available on the device is too small. Note: The NAND Flash partition can shrink as bit failures cause blocks to be invalidated. Go to “Format Fax Storage” on page 3-7 . If the issue is not fixed, replace the controller board. Go to “Controller board removal” on page 4-8 .
847.02	Fax Storage	The devices’ flash partition is invalid or unavailable. Go to “Format Fax Storage” on page 3-7 . If the issue is not fixed, replace the controller board. Go to “Controller board removal” on page 4-8 .
848.01	Modem/Config ID Mismatch	A device has a modem installed, but its Configuration ID indicates that a modem shouldn’t be present.
849	HD/Config ID Mismatch	A device doesn’t have a hard drive installed, even though its Configuration ID indicates that a hard drive should be present.

Error	Description	Action
849.01	HD/Config ID Mismatch	A device has a hard drive installed, but its Configuration ID indicates that a hard drive shouldn't be present.
Engine software service errors		
900.xx	RIP software error	Turn off MFP for 10 seconds and restart. If error re-occurs, replace controller board.
902.xx	Engine software error	Replace the controller board. See Go to “Controller board removal” on page 4-8
903.xx	Paperport link driver error	
904.xx	Interface violation by RIP	
905.xx	Interface violation by paperport device	
906.xx	RIP interface drive error	
DC pick motor errors		
910.xx	DC pick motor stall	
911.xx	DC pick motor excessive PWM	
912.xx	DC pick motor below speed	
913.xx	DC pick motor over speed	
914.00	DC pick motor error	
914.01	Lost encoder feedback	
Transfer service errors		
917.xx	Transfer service error	Replace the transfer roll. See “Transfer roll service check” on page 2-54.
Fuser service errors		
920.00	Under temperature during steady state control.	Replace the fuser. See “Fuser service check” on page 2-39.
921.00	Under temperature during standby control.	
922.00	Fuser failed to ramp to target temperature	
923.00	Fuser is over temperature.	
924.00	Open thermistor check.	
925.xx	Wrong fuser installed. The fuser type stored in the cartridge ID does not match the actual fuser installed in the printer.	
Fan service errors		
927.00	Service fan error	Replace the fan. See “Cooling fan service check” on page 2-37.
Toner service errors		

Error	Description	Action
929.00	Toner sensor error	Remove the toner cartridge, and shake it Try a different toner cartridge, if possible. If the error persists, then replace the toner level sensor. See “Toner level sensor removal” on page 4-82.
929.01	No home window	
929.02	No sensor transition (closed)	
929.03	No sensor transition (open)	
Printhead service errors		
930.xx	Wrong printhead installed	Replace the printhead. See “Printhead service check” on page 2-54.
931.xx	No first hsync	
		Replace the printhead. See “Printhead service check” on page 2-54.
932.xx	Lost hsyncs	
933.xx	Mirror motor locked: No hsync received	
935.xx	Motor unable to reach operating speed	
Transport motor service errors		
936.xx	Transport motor initial lock failure	Replace the main motor gear drive. See “Main motor service check” on page 2-40
937.00	Main transport motor lost lock	Replace the main motor gear drive. See “Main motor service check” on page 2-40
Power supply service errors		
940.00	LVPS service error	Replace the LVPS/HVPS. See “LVPS/HVPS service check” on page 2-39.
Controller board and operator panel service errors		
948.xx	Failed engine board	Replace the controller board. See “Engine board service check” on page 2-36.
949.xx		
950.xx	Mismatch between EEPROM and mirror memory Note: A new controller board or operator panel has been installed, and has not been properly prepared for this use. Install a new note. Do not install both the controller board and the operator panel at the same time without a POR in between.	Install a new controller board or operator panel. See “Engine board service check” on page 2-36 or “Operator panel service check” on page 2-43.
951.xx	Error with secure NVRAM on the controller board	Replace the controller board. See “Engine board service check” on page 2-36.
952.xx	A recoverable MVRAM Cyclic Redundancy Check error occurred.	Performing POR will clear this error.
953.xx	NVRAM chip failure with mirror	Replace the engine board. See “Engine board service check” on page 2-36.

Error	Description	Action
954.xx	NVRAM chip failure with system part.	Replace the controller board. See “Controller board service check” on page 2-35.
955.xx	The code ROM or NAND flash failed the Cyclic Redundancy Check or the NAND experienced an uncorrectible multi-bit failure.	
956.00	RIP card failure: processor failure	
956.01	Processor overtemp	
957.xx	RIP card failure: ASIC failure	
958.xx	Printer has performed more than 100 “shift and reflash” operations as a result of ECC bit corrections	
Firmware or controller board errors		
959.01	Controller verification failure of pensive boot code	Call the next level of support to update the firmware, or replace the controller board. See “Controller board service check” on page 2-35.
959.02	Failure to authenticate Signature Verification Code	
959.03	Signature Verification Code failed to authenticate a code partition.	Update firmware and call the next level of support, or replace the controller board. See “Controller board service check” on page 2-35.
959.04	Jump to unverified address	
959.05	Unknown boot failure	Update firmware and call the next level of support, or replace the controller board. See “Controller board service check” on page 2-35
959.20	Controller hardware failure	Replace the controller board. See “Controller board service check” on page 2-35.
959.21	Code did not respond to command request.	
959.22	Challenge secret failure	
959.23	Self test failed during initialization.	Replace the controller board. See “Controller board service check” on page 2-35.
959.24	EEPROM retention error	
959.25	Insufficient device space during HW prog	
959.26	Incremental counter reset exceeds maximum value	
959.27	Increment count failed due to max value limit	
959.28	Invalid SP memory configuration	
Memory and emulation errors		
960.xx	RAM memory error: RAM soldered on the controller board is bad	Replace the controller board. See “Controller board service check” on page 2-35.
961.xx	RAM memory error: memory card in slot is bad.	Replace the memory card.
964.xx	Download Emulation Cyclic Redundancy Check Error: checksum failure detected in the emulation header or emulation file.	Disable the Download Emulation. Program the download emulation into the firmware card again. If this does not resolve the problem, then replace the firmware card and download the emulation again.
Network errors		

Error	Description	Action
975.xx	Unrecognizable network	Call the next level of support.
976.xx	Unrecoverable software error in network port	
978.xx	Bad checksum while programming network port	
979.xx	Flash parts failed while programing network port	
Other errors		
980.xx	Engine experiencing unreliable communication with the specified device	Call the next level of support.
981.xx	Engine protocol violation detected by the specified device	
982.xx	Communications error detected by the specified device	
983.xx	Invalid command received by the specified device	
984.xx	Invalid command parameter received by the specified device	Call the next level of support.
990.xx	An equipment check condition has occurred in the specified device, but the device is unable to identify the exact component failure.	
991.xx	The specified device has detected an equipment check in its system card.	

Fax error codes

Fax error log codes

Error code	Description	Action
000	No error occurred during fax transmission	No action needed
200	Error occurred when transmitting training.	<ul style="list-style-type: none"> • Check line quality. • Select a lower 'Max Speed' value under Fax Send settings • Adjust the transmit level.
3XX	Error occurred when receiving image data.	<ul style="list-style-type: none"> • Check line quality. • Adjust 'Receive Threshold'. • Select a lower 'Max Speed' value under Fax Receive settings.
4XX	Error occurred when sending image data.	<ul style="list-style-type: none"> • Check line quality. • Adjust 'Transmit Level'. • Select a lower 'Max Speed' value under Fax Receive settings.
5XX	Received unknown response from remote fax device.	No action needed. Issue is with the other device.
6XX	Error occurred when receiving a frame.	<ul style="list-style-type: none"> • Check line quality. • Adjust 'Receive Threshold'.

Fax error log codes (Continued)

Error code	Description	Action
7XX	Error occurred when sending a frame.	<ul style="list-style-type: none"> • Check line quality. • Adjust 'Transmit Level'. • Select a lower 'Max Speed' value under Fax Send settings.
800	Received EOT unexpectedly from the modem in V34 mode.	<ul style="list-style-type: none"> • If error persists disable V34 modulation scheme.
802	Too many timeouts occurred during ECM reception.	<ul style="list-style-type: none"> • If error persists disable ECM mode.
803	Fax cancelled by user	No action needed.
804	Unexpectedly received a disconnect command from the remote end.	<ul style="list-style-type: none"> • Check line quality. • Adjust Transmit Level/Receive Threshold values. • Remote device could be requesting an unsupported feature.
805	Remote fax device failed to respond to the DCS command.	<ul style="list-style-type: none"> • Adjust Transmit Level/Receive Threshold values. • Remote device could be malfunctioning.
808	T1 timeout occurred when trying to establish a connection with a remote fax device.	<ul style="list-style-type: none"> • Adjust Transmit Level/Receive Threshold values.
809	T2 Timeout occurred due to loss of command/response synchronization.	<ul style="list-style-type: none"> • Adjust Transmit Level/Receive Threshold values.
80A	T5 Timeout occurred when transmitting image data to remote fax device.	<ul style="list-style-type: none"> • Check line quality. • Adjust 'Transmit Level'. • Select a lower 'Max Speed' value under Fax Send settings.
80B	Too many errors when transmitting in ECM mode.	<ul style="list-style-type: none"> • Check line quality. • Adjust 'Transmit Level'. • Select a lower 'Max Speed' value under Fax Send settings.
80C	Remote device failed to respond to the CTC command.	<ul style="list-style-type: none"> • Select a lower 'Max Speed' value under Fax Send settings. • Adjust 'Transmit Level'.
80D	Received too many requests from remote end to repeat the previous command sent.	<ul style="list-style-type: none"> • Check line quality. • Adjust 'Transmit Level'. • Check if line conditions on remote end will facilitate a good connection.
80E	Functional limitation- Remote fax device does not support G3 receive capability.	No action needed. Issue with the remote device.
811	Failed to detect a fax device at the remote end.	<ul style="list-style-type: none"> • Verify MFD is answering to fax call and not a voice call. • Decrease value of 'Rings To Answer' setting.
812	No more data rates available in V34 modulation scheme.	<ul style="list-style-type: none"> • Adjust to a lower modulation scheme.

Fax error log codes (Continued)

Error code	Description	Action
813	Timeout occurred after waiting too long to receive a good frame.	<ul style="list-style-type: none"> Adjust "Receive Threshold".
814	Tried too many times at selected speed using V34 modulation scheme.	<ul style="list-style-type: none"> Adjust 'Transmit Level'. Adjust to a lower modulation scheme.
815	Fax transmission was interrupted due to power failure.	<ul style="list-style-type: none"> Troubleshoot MFP if error persists. See "Modem / fax card service check" on page 2-63.
818	Fax transmission failed due to insufficient memory to store scanned image.	Adjust 'Memory Use' setting to allocate more memory for send jobs.
819	Fax transmission failed due to insufficient memory to store received image.	Adjust 'Memory Use' setting to allocate more memory for receive jobs.
81A	A timeout occurred during transmission of a page in ECM mode.	Select a lower 'Max Speed' value under Fax Send settings.
880	Failure to transmit training successfully in V17, V29, V27 terminal modulation schemes.	<ul style="list-style-type: none"> Select a lower "Max Speed" under Fax Send settings. Adjust the "Transmit Level". Check line quality.
881	Failure to transmit training successfully in V33, V29, V27 terminal modulation schemes.	<ul style="list-style-type: none"> Select a lower "Max Speed" under Fax Send settings. Adjust the "Transmit Level". Check line quality.
882	Failure to transmit training successfully in V17, V29 terminal modulation schemes.	<ul style="list-style-type: none"> Select a lower "Max Speed" under Fax Send settings. Adjust the "Transmit Level". Check line quality.
883	Failure to transmit training successfully in V17, V27 terminal modulation schemes.	<ul style="list-style-type: none"> Select a lower "Max Speed" under Fax Send settings. Adjust the "Transmit Level". Check line quality.
884	Failure to transmit training successfully in V29, V27 terminal modulation schemes.	<ul style="list-style-type: none"> Select a lower "Max Speed" under Fax Send settings. Adjust the "Transmit Level". Check line quality.
885	Failure to transmit training successfully in V17 terminal modulation scheme.	<ul style="list-style-type: none"> Select a lower "Max Speed" under Fax Send settings. Adjust the "Transmit Level". Check line quality.
886	Failure to transmit training successfully in V29 terminal modulation scheme.	<ul style="list-style-type: none"> Select a lower "Max Speed" under Fax Send settings. Adjust the "Transmit Level". Check line quality.
887	Failure to transmit training successfully in V27 terminal modulation scheme.	<ul style="list-style-type: none"> Select a lower "Max Speed" under Fax Send settings. Adjust the "Transmit Level". Check line quality.

Fax error log codes (Continued)

Error code	Description	Action
888	Failure to transmit training successfully at 2400 bps in V27 terminal modulation scheme.	<ul style="list-style-type: none"> Adjust "Transmit Level". Check line quality.
889	Failed to connect at the minimum speed supported by the MFP.	<ul style="list-style-type: none"> Adjust "Transmit Level". Incompatible connection.
88A	Failed to connect using V.34 modulation scheme.	<ul style="list-style-type: none"> Check line quality. Adjust to a lower modulation scheme. Adjust Transmit Level Receive Threshold values.
901	No fax tones detected from remote end.	<ul style="list-style-type: none"> Verify destination phone number. Verify that the remote fax is authorized to receive faxes.
902	No dial tone detected.	<ul style="list-style-type: none"> Check by enabling 'Behind a PABX' setting. Check phone line. Check MFD modem hardware.
903	Busy tone detected.	Check with remote end if successive attempts fail.
904	Hardware error detected.	See "Modem / fax card service check" on page 2-63.
905	A timeout occurred after dialing the number and waiting for a response.	Check with remote end if successive attempts fail.
906	Fax cancelled by user.	No action needed.
907	Modem detected a digital line connection.	Verify the MFP is connected to an analog line. See "Fax transmission service check" on page 2-64.
908	Phone line was disconnected	Restore phone line connection.
A00	Received request for unsupported function from remote fax device.	No action needed.
A01	Received request for unsupported image width from remote fax device.	No action needed.
A02	Received request for unsupported image resolution from remote fax device.	No action needed.
A03	Received request for unsupported compression type from remote fax device.	No action needed.
A04	Received request for unsupported image length from remote fax device.	No action needed.
F00	Unknown error occurred.	No action needed.

Service checks



Service checks which involve measuring voltages on the LVPS/HVPS (low voltage power supply/high voltage power supply board) should be performed with the printer positioned on its back side.

Note: When making voltage readings, always use frame ground unless another ground is specified. See the wiring diagram in the back of the book for more information.

Note: The controller board is located beneath the flatbed. To access the controller board, see **“ADF unit removal” on page 4-88.**

Controller board service check

Controller board service check

FRU	Action
Controller board assembly	<p>POST (Power-On Self Test)</p> <p>Note: The printer should complete POST in approximately 45 seconds.</p> <p>If the printer fails to display lights or activate the drive motor, fuser, or fan, then check the following order:</p> <ol style="list-style-type: none"> 1. Power to the LVPS/HVPS. 2. Power from the LVPS/HVPS to the engine board. See “Engine board service check” on page 2-36. 3. Power from the engine board to the controller board. 4. Cables are plugged in correctly, especially for the operator panel. The printer will not power-up without a functioning operator panel. 5. The operator panel. See “Operator panel service check” on page 2-43.
	<p>Verify +24 V dc and +5V dc input from the engine board.</p> <ol style="list-style-type: none"> 1. Turn the printer off. 2. Disconnect the controller board power cable from the engine board at J503. 3. Turn the printer on. 4. Verify +24 V dc on positions 17, and 19 of the cable connector (J503). 5. Verify +5 V dc on positions 11, 13, 15 on J503. 6. If voltages are correct on the engine board, then check the continuity in the other conductors of the cable. If the cable is good, then turn the printer off, and check the connectors on the controller board. If the cable isn't good, replace the controller board cable. 7. Verify that pins 10, 12, 14, 16, and 18 on both the cable and the engine board connector are grounded. 8. If grounds are not correct on the cable, but the cable passes continuity otherwise, then check the controller board. 9. If the grounds are not correct on the controller board, then replace the controller board. (Check with one probe on the connector pin and the other on the card's ground plane found at each screw head.)

Engine board service check

Engine board service check

FRU	Action						
Engine board assembly	<p>POST (Power-On Self Test)</p> <p>Note: The printer should complete POST in approximately 45 seconds.</p> <p>If the printer fails to display lights or activate the drive motor, fuser, or fan, then check the following order:</p> <ol style="list-style-type: none"> 1. Power to the LVPS/HVPS 2. Power from the LVPS/HVPS to the engine board. 3. Cables are plugged in correctly, especially for the operator panel. The printer will not power-up without a functioning operator panel. 4. The operator panel. See “Operator panel service check” on page 2-43. <hr/> <p>Verify +24 V dc input from the LVPS/HVPS.</p> <ol style="list-style-type: none"> 1. Turn the printer off. 2. Disconnect the LVPS/HVPS cable from the engine board at J502. 3. Turn the printer on. 4. Verify +24 V dc on positions 6, 17, and 19 of the cable connector (LVPS/HVPS). 5. If voltage is correct, then check the continuity in the other conductors of the cable. If the cable is good, then turn the printer off, and check the connectors to the controller board. 6. Verify that pins 10, 12, 14, 16, and 18 on both the cable and the card connector are grounded. 7. If grounds are not correct on the cable, but the cable passes continuity otherwise, then check the LVPS/HVPS. 8. If the grounds are not correct on the engine board, then replace the engine board. (Check with one probe on the connector pin and the other on the card's ground plane found at each screw head.) <hr/> <p>Engine board voltage outputs</p> <p>Turn the printer off, and plug the LVPS/HVPS cable into J502 of the engine board. See the wiring diagram at the end of the manual which identifies the output voltages and grounds for a good engine board.</p> <p>Turn the printer off before plugging or unplugging any connectors.</p>						
LVPS/HVPS	<p>Verify main power to engine board</p> <p>With the printer off, unplug the LPS/HVPS cable at J502 on the controller board. Verify grounds on pins 10, 12, 14, 16 and 18 for both the cable and the engine board. If any of these grounds are incorrect, then check the cable for continuity. If the cable fails continuity, then call the next level of support.</p> <p>Turn the printer on with the cable still unplugged, and verify the following on the cable (engine board will not be powered):</p> <table border="1" data-bbox="740 1451 1117 1604"> <thead> <tr> <th>Pins</th> <th>Voltage</th> </tr> </thead> <tbody> <tr> <td>6, 17, 19</td> <td>+24 V dc</td> </tr> <tr> <td>1, 3-5, 7, 11, 13, 15</td> <td>+5 V dc</td> </tr> </tbody> </table> <p>If any of the voltages are incorrect, then replace the LVPS/HVPS. See “Dead machine service check” on page 2-38.</p>	Pins	Voltage	6, 17, 19	+24 V dc	1, 3-5, 7, 11, 13, 15	+5 V dc
Pins	Voltage						
6, 17, 19	+24 V dc						
1, 3-5, 7, 11, 13, 15	+5 V dc						

Cooling fan service check

FRU	Action
Cooling fan	<p>Make sure the fan cable plug is properly seated at J36 (engine board).</p> <p>Turn the printer on. Within a few seconds, the engine board assembly should apply +24 V dc to pin 2.</p> <ul style="list-style-type: none"> • If voltage is not present, then check or replace the engine board. See “Engine board removal” on page 2-15. • If voltage is present, then check pin 1 for 24 V dc as well. If it is close to 24 V dc while the fan is still idle, then replace the fan. See “Fan removal” on page 2-24.

Cover interlock switch service check

Note: Make sure a print cartridge assembly is installed and the cover closes all the way, engaging the cover open switch lever.

FRU	Action
Cover interlock switch	<p>Disconnect the cover interlock cable from the controller board at J11.</p> <p>With the printer turned off:</p> <ol style="list-style-type: none"> 1. Verify continuity between cable pin 1 and pin 2 with the door closed and discontinuity with the door open. 2. Verify continuity between cable pin 1 and pin 3 with the door open and discontinuity with the door closed. 3. Verify discontinuity between cable pins 2 and 3 whether the door is open or closed. <ul style="list-style-type: none"> • If any fail, then replace the cover interlock switch. • If both pass continuity, then turn the printer on, and measure +5 V dc on pin 2 at J11 on the controller board. • Verify pin 3 at J6 is ground. • If voltage or ground is not present, then see “Engine board service check” on page 2-36 for more information.

Dead machine service check



CAUTION: Check the AC line voltage. The voltage should be within the following limits:

- 100 V ac (volts alternating current)-127 V ac for the 110 V printer
- 200 V ac-240 V ac for the 220 V printer

FRU	Action								
 LVPS/HVPS	<p>Unplug the printer. Remove the LVPS/HVPS, and check the fuses for continuity.</p> <ul style="list-style-type: none"> • If open, then replace the LVPS/HVPS. • If not open, then check the switch continuity across its conductors with the switch on. Turn the switch off. Plug the AC line into the LVPS/HVPS and switch unit on. <p>Note: Voltages are exposed at several places on the board. Do these verifications, and then unplug the AC cord from the power supply:</p> <table border="1" data-bbox="740 653 1117 894"> <thead> <tr> <th>Pins</th> <th>Voltage</th> </tr> </thead> <tbody> <tr> <td>CN201-6, 17, 19</td> <td>+24 V dc</td> </tr> <tr> <td>CN201-10, 12, 14, 16, 18</td> <td>Ground</td> </tr> <tr> <td>CN201-1,3, 5, 11,13, 15</td> <td>+5 V dc</td> </tr> </tbody> </table> <ul style="list-style-type: none"> • If voltages are not correct, then replace the LVPS/HVPS. • If voltages are correct, then check the engine board. See “Engine board service check” on page 2-36. • If the engine board checks out ok, perform the controller board service check. 	Pins	Voltage	CN201-6, 17, 19	+24 V dc	CN201-10, 12, 14, 16, 18	Ground	CN201-1,3, 5, 11,13, 15	+5 V dc
Pins	Voltage								
CN201-6, 17, 19	+24 V dc								
CN201-10, 12, 14, 16, 18	Ground								
CN201-1,3, 5, 11,13, 15	+5 V dc								

Fuser service check

When toner is partially fused to the media, it is usually caused by low fuser temperature.



The line voltage to the printer must be within the following limits:

- 100 V ac-127 V ac for the 110 V model printer
- 200 V ac-240 V ac for the 220 V model printer



This printer uses a belt fuser and therefore does not have a lamp.

Fuser service check

FRU	Action
 <p>Fuser power cable LVPS/HVPS Fuser</p>	<p>Unplug the printer, and disconnect the fuser cable plug from the LVPS/HVPS board connector at CN102.</p> <p>Check for continuity across the fuser by checking across the connector pins.</p> <ul style="list-style-type: none"> • If there is continuity, then check the LVPS/HVPS. See “LVPS/HVPS service check” on page 2-39. • If there is no continuity, then disconnect the fuser power cable at both ends and check each conductor for continuity. Replace cable if necessary. • If the cable tests good, then replace the fuser. <p>Reconnect the cables, turn the printer on, and at &12, check for approximately +5 V dc on pin 1 and ground on pin 2. If line voltage is incorrect on pin 1, then see “Engine board service check” on page 2-36 for more information.</p>
 <p>Fuser</p>	<p>Disconnect the thermistor cable from J12 on the engine board.</p> <p>Measure the resistance across the ends of the thermistor cable.</p> <p>Replace the fuser assembly if the resistance is lower than 1K ohm or shorted.</p> <p>Note: Resistance measures approximately 400K ohms when cool and 1K ohms hot.</p>

LVPS/HVPS service check

FRU	Action
 <p>LVPS/HVPS</p>	<p>LVPS portion of board Fuses that open typically indicate a faulty LVPS/HVPS.</p> <p>Disconnect the power cable, and open the LVPS/HVPS enough to test the switch. The switch will show continuity across the conductors with a meter when the switch is on. If the switch is good, then see “Dead machine service check” on page 2-38 for more diagnostics.</p> <p>HVPS portion of board Problems with the HVPS are exhibited in the print quality. See “Print quality service checks” on page 2-47 for more information.</p>

Main motor service check

FRU	Action						
 <p>Main motor gear drive Main motor cable LVPS/HVPS Engine board</p> <p>Warning: Do not replace the engine board and controller board at the same time. Each board contains the printer settings. When either of these boards is new, it obtains the settings from the other board. Settings are lost when both are new and replaced at the same time.</p>	<p>Turn off the printer, and unplug the main motor cable at J17 on the engine board. Turn on the printer, and check for the following voltages at J17:</p> <table border="1" data-bbox="721 394 1133 520"> <thead> <tr> <th>J17 pins</th> <th>Voltages</th> </tr> </thead> <tbody> <tr> <td>Pins 1-4, 6</td> <td>Approx. 5 V dc</td> </tr> <tr> <td>Pins 7-9</td> <td>18 V dc-24 V dc</td> </tr> </tbody> </table> <p>Verify ground at pin 5 for both the card and cable.</p> <ul style="list-style-type: none"> If these voltages are correct, then check the main motor cable for continuity. <ul style="list-style-type: none"> Remove the left side cover to access the connector on the motor. If continuity exists on each wire, then replace the main motor gear drive which includes the motor. If continuity does not exist on one or more of the wires, then call the next level of support. If these voltages are not correct, then see “Lexmark X46x controller and engine board connector pin values” on page 2-6, or replace the engine board. See “Engine board removal” on page 2-15. 	J17 pins	Voltages	Pins 1-4, 6	Approx. 5 V dc	Pins 7-9	18 V dc-24 V dc
J17 pins	Voltages						
Pins 1-4, 6	Approx. 5 V dc						
Pins 7-9	18 V dc-24 V dc						

Media feed clutch service check

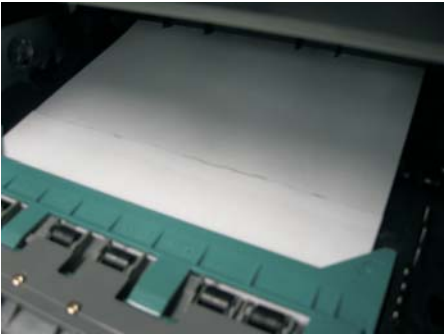
Step	Action and questions	Yes	No
1	<p>Clear the paper path of all sheets of paper. Turn on the printer. Open the front door of the printer.</p>  <p>Is the paper overlapping with no space between the trailing edge of the first sheet and leading edge of the second?</p>	Go to step 3.	Go to step 2.
2	<p>Check the paper path sensors for any dirt, dust or paper that might be obstructing the sensors.</p> <p>Does this solve the problem?</p>	Problem resolved	Go to step 3.
3	<p>Replace the media feed clutch. See “Media feed clutch removal” on page 4-50.</p> <p>Does this solve the problem?</p>	Problem resolved	Contact your next level of support.

Networking service check

Note: Before starting this service check, print out the network setup page. This page is found under Menu - Reports - Network Setup Page. Consult the network administrator to verify that the physical and wireless network settings displayed on the network settings page for the device are properly configured. If a wireless network is used, verify that the printer is in range of the host computer or wireless access point, and there is no electronic interference. Have the network administrator verify that the device is using the correct SSID, and wireless security protocols. For more network troubleshooting information, consult the Lexmark Network Setup Guide.

Step	Questions / actions	Yes	No
1	If the device is physically connected to the network, verify that the ethernet cable is properly connected on both ends. Is the cable properly connected?	Go to step 3. If the network is wireless, got to step 3.	Go to step 2.
2	Connect the ethernet cable. Did this fix the problem?	Problem resolved	Go to step 3.
3	Check the printer's online status under Printers and Faxes on the host computer. Delete all print jobs in the print queue. Is the printer online and in a Ready state.	Go to step 5.	Go to step 4.
4	Change the printer status to online. Did this fix the issue?	Problem resolved.	Go to step 5.
5	Does the IP address displayed on the network settings page match the IP address in the port of the drivers using the printer?	Go to step 10.	Go to step 6.
6	Does the LAN use DHCP? Note: A printer should use a static IP address on a network.	Go to step 7.	Go to step 9.
7	Are the first two segments if the IP address 169.254?	Go to step 8.	Go to step 9
8	POR the printer. Is the problem resolved	Problem resolved	Go to step 10.
9	Reset the address on the printer to match the IP address on the driver. Did this resolve the issue?	Problem fixed.	Go to step 10.
10	Have the network admin verify that the printer and PC's IP address have identical subnet addresses. Are the subnet addresses the same?	Go to step 12.	Go to step 11.
11	Using the subnet address supplied by the network admin, assign a unique IP address to the printer. Note: The printer IP address should match the IP address on the printer driver. Did this fix the problem?	Problem resolved.	Go to step 12.
12	Is the device physically connected (ethernet cable) to the network?	Go to step 13.	Go to step15.

Step	Questions / actions	Yes	No
13	Try using a different ethernet cable. Did this remedy the situation?	Problem resolved	Go to step 14.
14	Have the network administrator check the network drop for activity. Is the drop functioning properly?	Replace the controller board. Go to "Controller board removal" on page 4-8	Contact the network administrator.
15	Is the printer on the same wireless network as the other devices?	Go to step 17.	Go to step 16.
16	Assign the correct wireless network to the printer. Did this fix the problem?	Problem resolved	Go to step 17.
17	Are the other devices on the wireless network communicating properly?	Go to step 18.	Contact the network administrator.
18	Verify that the ISP wireless card cable and any other ISP cables are properly seated in their connectors. Are the cables connected correctly?	Go to step 20.	Go to step 19.
19	Properly reseal the ISP cables. Did this fix the problem?	Problem resolved.	Go to step 20.
20	Perform the option card service check. See "Option card service check" on page 2-46. Was there another faulty ISP option?	Replace the faulty ISP option. See "Installing an Internal Solutions Port (ISP)" on page 2-106.	Go to step 21.
21	Replace the ISP wireless card? See "Installing an Internal Solutions Port (ISP)" on page 2-106. Did this fix the problem	Problem resolved.	Replace the controller board. Go to "Controller board removal" on page 4-8.

Operator panel service check

Inspect the operator panel cable for damage. Make sure the cable is plugged in securely. Run POST, and check each light for proper operation. See **“Power-On Self Test (POST) sequence” on page 2-1.**

Touch screen operator panel service check

FRU	Action
Operator panel Display Operator panel keyboard Controller board Warning: Do not replace the engine board and controller board at the same time. Each board contains the printer settings. When either of these boards is new, it obtains the settings from the other board. Settings are lost when both are new and replaced at the same time.	<p>Touchscreen display</p> <p>If the touchscreen display does not come on or indicator LED on the keyboard doesn't illuminate, then open the controller board cage and locate the operator panel connector at J34. Make sure the cable is properly connected to the controller board and the controller board has input voltage to it.</p> <p>With the printer on, verify the following on connector J34:</p> <ul style="list-style-type: none"> • Pins 1, 3, 5, and 6: 3.3 v • Pin 10, 16, 17, and 18: 5 v • Pins 2, 9, and 15: GND <p>If any are incorrect, then see “Controller board service check” on page 2-35.</p> <p>If these are approximately correct and the operator panel is not functioning:</p> <ol style="list-style-type: none"> 1. Turn the printer off. 2. Remove the left and right covers, 3. Tilt the operator panel keyboard and verify the UICC cable is properly connected to the keyboard at connector J10. 4. If the cable is properly connected at both ends, check the cable for continuity. If the cable fails, replace the UICC cable. 5. Reconnect the UICC cable, and verify the display ribbon cables are properly connected to J3 and J12 on the keyboard. 6. Restart the printer. If the eight LEDs on the bottom of the keyboard card illuminate, but the display fails to illuminate, replace the touchscreen display. 7. If the eight LEDs fail to illuminate, replace the keyboard.
	<p>Button keypad</p> <p>If the touchscreen is ok, POR into Diagnostic mode, and perform the Button test under the Hardware tests. If the buttons do not respond, then replace the keyboard .</p>

Paper feed service checks

Paper jam error indication during POST

FRU	Action
Fuser (exit sensor)	If the exit sensor flag, which is visible at the back of the fuser, is in any position other than vertical, then the printer will display a paper jam. Make sure the flag is operating freely. Replace the fuser if the sensor is damaged.
Input/duplex sensor Manual feed sensor	Make sure the input paper feed sensors are working properly. A stuck or incorrectly installed sensor causes a paper jam indication.

Media picks but stops halfway through the printer

FRU	Action
Input/duplex sensors (under print cartridge assembly) Input sensor (manual) Stairway cables	<p>Check the stairway cables to verify they are properly connected to the engine board at connectors J500 and J501, and on the controller board at connectors J26 and J27.</p> <p>If they are properly connected verify continuity on both cables. If this fails replace the cables.</p> <p>Make sure the input sensors are working properly.</p> <p>Check for a broken or stuck flag on the input sensors. Clear anything that keeps the flags from rotating freely.</p> <p>Make sure the cables are seated on the engine board at J27 (input/duplex sensor) and J23 (manual input).</p> <p>Check for +5 V dc on pin 2 and 5 at J27 on the engine board (input/duplex sensors) and pin 2 at J23 on the engine board (Input sensor). Voltages on pins 1 and 4 at J27, and pin 1 at J23 should change as the flags intersect with the sensor.</p> <ul style="list-style-type: none"> • If correct, then replace the input paper feed sensor. • If these voltages are not correct, then replace the controller board. • Check the pick tires. Clean or replace as necessary.

Media never picks

FRU	Action
Paper feed (pick tires) tray 1 Paper feed (pick tires) tray 2 Media drive ASM Media feed clutch ASM Manual feed clutch ASM P/U and manual feed solenoid ACM drive shaft	<p>Open the left cover, and verify that the solenoids and clutches are functioning when an attempt is made to feed the media.</p> <p>Make sure the rubber tires on the ACM are installed and clean.</p> <p>Replace the tires, ACM drive, clutch assemblies, solenoids, or drive shaft as necessary.</p>

Media occasionally mispicks or picks multiple sheets at once

FRU	Action
Tray 1 Tray 2 (option)	<p>Check tray for media catch points.</p> <p>If the sheet being fed stops momentarily, then the ACM applies additional vertical force, causing additional sheets to feed.</p> <p>Do not mix media types in one tray.</p>
Paper pick tires (Tray 1 or tray 2)	<p>Check the tires in the ACM assembly for signs of wear or damage.</p> <p>Replace the tires as necessary.</p>
ACM clutch Manual feed clutch Media feed clutch ASM (tray 1 only) Manual feed clutch solenoid	<p>Open left cover, and observe the solenoid and clutch actions at the ACM and manual feed shafts as a print job is attempted.</p> <p>Replace the faulty part.</p>

FRU	Action
Engine board P/U and manual feed solenoid ASM	<p>Check the stairway cables to verify they are properly connected to the engine board at connectors J500 and J501, and on the controller board at connectors J26 and J27.</p> <p>If they are properly connected verify continuity on both cables. If this fails replace the cables.</p> <p>Disconnect the solenoid cable at J25 on the engine board and measure the resistance across cable pins 1 and 2.</p> <ul style="list-style-type: none"> • The resistance should be approximately 70 ohms. • If it is not, then replace the solenoid. • If the resistance is approximately 70 ohms, then check the controller board. Pin 1 at J25 on the engine board should be +24 V dc. See Engine Board SVC Check for more information. <p>Replace engine board as necessary.</p>

Media skews

FRU	Action
Paper feed (pick tires) tray 1 Paper feed (pick tires) tray 2 Tray 1 Tray 2 (option)	<p>Check tires for debris. If tires are new, then try reversing each on its hub.</p> <p>Check side guides on Tray 1 and Tray 2. Guides set for a full stack of media may be too wide when the stack is short.</p>

Media “trees,” wrinkles, stacks poorly, or curls

FRU	Action
Fuser	<p>This problem is most likely due to a worn backup roll. It causes the printer to run hotter than required for the media being printed. Excessive heat can cause media treeing problems, poor stacking, or curl.</p> <p>Print the menu sheet found under Utilities.</p> <p>Look at the media settings. Some, such as card stock or rough texture, may require a higher fuser temperature, which leads to more of these problems (except stacking) in plain paper.</p> <ul style="list-style-type: none"> • Change settings using the printer driver. • Use the local printer setup utility (included on the CD) to change the NVRAM settings. <p>Try a different ream of paper. Moist media has a higher tendency to crease (treeing) and curl.</p>

Option card service check

Option card service check

FRU	Action
Option cards Controller board Option card connection cable Warning: Do not replace the engine board and controller board at the same time. Each board contains the printer settings. When either of these boards is new, it obtains the settings from the other board. Settings are lost when both are new and replaced at the same time.	<p>Card</p> <p>Remove all the option cards from the device.</p> <p>Install each card individually. Restart the MFP after each card is installed.</p> <p>Remove the card and repeat the previous step with a different card till all cards are checked.</p> <p>When a faulty card is found, replace the card. See “Option board installs and removals” on page 4-105. If the error persists after replacing the option card, replace the controller board. See “Controller board removal” on page 4-8.</p> <p>If there are no errors found testing the cards individually, install the cards on at a time. Restart the MFP after each card is installed.</p> <p>Cables</p> <p>If the cards do not trigger an error, check the option card connection cables for continuity.</p>

USB port service check

1. Perform a print test to make sure the printer prints correctly. Verify that the indicator light is on, then print the menu settings by **Menu Settings Page** from the **Reports Menu** in the menus.
2. Be sure the printer usb cable is designed for bidirectional printing.
3. Be sure the user's application is set up correctly.
4. If the internal print test page prints correctly, the user's application/printer driver is set up correctly, and the USB cable is installed, but the printer still fails to print on command from the host computer, then replace the controller board.
5. Check the USB cable for continuity.

Print quality service checks

Note: Ensure the cover closes tightly. A gap in the opening may allow light to expose the photoconductor, resulting in a 'dirty' print. Extreme environmental conditions, temperatures, and humidity will affect the print quality.

Using print quality test pages

To help isolate print quality problems, like streaking, print test pages using the print quality test pages. To print the print quality test pages:

1. Enter Configuration Menu.
 - a. Turn off the printer.
 - b. Turn on the printer while pressing and holding 2 and 6.
 - c. Release the buttons after 10 seconds.
 - d. Touch **Print Quality Pages** to print out the quality pages.
Four pages print to help evaluate print quality. The first page has various fonts and a graphic, the second page is gray with graphics, the third page is black, and the last page is blank.
2. Use the test pages to isolate problems such as light or toner streaks. See **“POST symptom table” on page 2-2** for solutions to these problems.
3. Scroll down to Exit Config Menu and touch the menu item on the screen. The machine will POR.

Note: Refer to the print defects guide at the end of the manual for repeating defects.

Blank page

FRU	Action
Toner cartridge (not a FRU)	Remove the toner cartridge, and gently shake it to evenly distribute the toner. Check for cartridge damage.
 Printhead LVPS/HVPS Controller board	Blank pages can be caused by a defective printhead assembly, LVPS/HVPS, or controller board. <ul style="list-style-type: none"> • Printhead errors typically result in printer service errors unless there is blockage of the beam or dust on the lens. Check the lens and opening for blockage. • Blank pages typically are caused by the PC roll not being properly charged. Try a different PC kit. • With the cartridge out, check the spring loaded contacts on the right side for free motion. None should be ground except for #4 contact from the front. Unplug the printer, and check the cable continuity between the LVPS/HVPS connector marked OPC (at CN202) and the corresponding wire form (spring) found about 14 mm above and to the right of the transfer roll gear. <ul style="list-style-type: none"> • If there is not continuity, then call the next level of service. Try a different toner cartridge and PC kit. <ul style="list-style-type: none"> • If those fail, then replace the LVPS/HVPS, controller board, or the printhead in that order. Also, see “Solving print quality problems” on page 2-51 .

Black page

Note: Incorrect laser exposure or incorrect charging of the photoconductor causes an all black page. Always verify the same results from a different print cartridge assembly and developer before proceeding.

FRU	Action
Toner electrodes (not a FRU)	<p>Check the three rearward electrodes below the toner cartridge assembly for contamination, damage, or a short to ground. Correct as necessary.</p> <p>Check continuity between the cable (DEV, TAR, and doctor blade) connection PCN3 and on the contact tips below the toner cartridge assembly.</p> <ul style="list-style-type: none"> • If continuity fails, then call the next level of service.
 <p>LVPS/HVPS board Controller board Miscellaneous cables</p>	<p>With the printer off, disconnect the LVPS/HVPS cable from J502 on the engine board.</p> <p>Turn the printer on, and verify +24 V dc on pins 17 and 19 of the cable.</p> <p>Verify +5 V dc on pins 1, 3-5, 11, 13, and 15.</p> <p>Verify ground on pins 10, 12, 14, 16, and 18.</p> <ul style="list-style-type: none"> • If any of the values are incorrect, then replace LVPS/HVPS board. • If the grounds are incorrect, then check ground paths. • Check continuity in the cable. If the cable is bad, then call the next level of support. • If the values are correct and the toner electrodes are good, then replace the controller board. • See the “LVPS/HVPS service check” on page 2-39 and the “Engine board service check” on page 2-36, if necessary.

Heavy background

Poor development or poorly charged toner particles cause excessive background. This is more noticeable as the toner cartridge nears end-of-life.

FRU	Action
Toner cartridge (not a FRU) PC Kit (not a FRU)	<p>Check the toner darkness setting in the driver. Try a lower setting.</p> <p>Make sure the toner cartridge and PC Kit are correctly installed and the high voltage contacts are clean.</p> <p>If the toner cartridge and PC Kit are installed correctly, then try a new PC Kit first and then toner cartridge.</p>
 <p>LVPS/HVPS Engine board</p>	<p>Check the contacts for correct installation and contamination where contact is made between the print cartridge assembly and spring contacts which connect to the LVPS/HVPS board at CN203. Clean as necessary.</p> <p>If this does not correct the problem, then replace the following FRUs one at a time in the order shown:</p> <ul style="list-style-type: none"> • LVPS/HVPS board (See “Black page” on page 2-48 for pin values.) • Engine board

Partial blank image/white spots (no repeating pattern)

FRU	Action
Toner cartridge (not a FRU)	Remove the toner cartridge assembly, and gently shake the assembly to evenly distribute the toner. Check to make sure that the laser light path is not blocked. If toner cartridge is low, then try a new one.
Paper (not a FRU)	Make sure recommended media is being used. Check the media settings in the printer driver. A heavier media may require higher heat to properly fuse.

Variation in image density horizontally across page

FRU	Action
PC Kit (not a FRU)	The charge roll may have an unbalanced force against the PC (photoconductor) drum. Try a new PC Kit.
Transfer roll	Note: Do not touch the transfer roll except at its ends. Place a sheet of paper over the roll to prevent damage from finger oils or hand lotion. Check the springs in the left and right transfer roll bearings. The bearing assemblies should support the transfer roll, applying evenly distributed forces to the PC drum. Replace the transfer roll assembly if the springs or bearings show signs of damage, or fatigue. Inspect the transfer roll for signs of wear, damage or contamination. Replace as necessary.

Poor fusing of image

FRU	Action
Fuser	The fuser may not be operating at the proper temperature to fuse the toner to the paper. See “LVPS/HVPS service check” on page 2-39 for more information. Try changing the setting to heavier paper or even card stock.
Media (not a FRU)	Make sure recommended media is being used. Check the media settings in the printer driver.

Light print

FRU	Action
Toner cartridge (not a FRU)	<p>Make sure the toner cartridge and PC Kit are installed correctly and that the toner cartridge is not low on toner.</p> <p>If the problem continues, then install a new toner cartridge.</p> <p>Recheck condition before replacing PC Kit, if necessary.</p>
 <p>Transfer roll LVPS/HVPS card</p>	<p>Check the transfer roll for signs of toner buildup and contamination.</p> <p>Inspect the HVPS contact (transfer roll) for contamination.</p> <p>Verify the high voltage cable is plugged into the LVPS/HVPS.</p> <p>If all components appear free of contamination, then replace the following FRUs one at a time in the order shown:</p> <ul style="list-style-type: none"> • Transfer roll • LVPS/HVPS card

White or black lines or bands

FRU	Action
Print cartridge assembly (not a FRU) Developer drive coupling assembly Main motor gear drive	<p>Banding appears as light or dark horizontal lines on a uniformly gray page or on a page with a large area of graphics. Banding is primarily due to a variation in the speed of the media as it feeds through the printer, especially in the developer and transfer process. It may also be a result of overly dry or moist environments.</p> <p>With the printer off, check to make sure that the laser beam is not blocked.</p> <p>Inspect the toner cartridge and paper feed components, especially the drive coupler and drive gears for debris, binds, or damage.</p>

Toner on back of page

FRU	Action
Photoconductor kit (not a FRU)	<p>Print a menu page from the Menu Settings Page in the Reports menu.</p> <p>Inspect the overall paper path for signs of spilled toner.</p> <p>Gently clean the contaminated areas with a soft cloth.</p>
Fuser	<p>Inspect the fuser for signs of contamination.</p> <p>Replace the fuser as necessary.</p>
Transfer roll	<p>A transfer roll contaminated with toner can cause toner to transfer to the back of pages.</p> <p>Inspect the transfer roll for contamination and its cable for continuity.</p>
HVPS or engine board	<p>Loss of the proper high voltages can cause excessive toner to contaminate the transfer roller. None of these voltages can be measured, but the contacts and continuities can be checked. To check the lower voltage, see J502 on the wiring diagram. Replace the LVPS/HVPS or controller board as necessary.</p>

Solving print quality problems

Note: Refer to the print defects guide at the end of the manual for repeating defects.

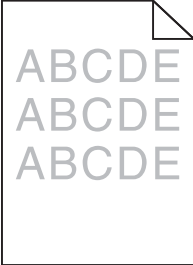
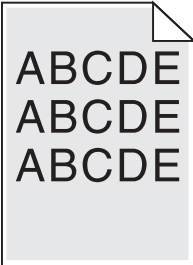
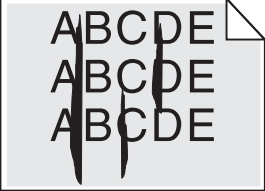

Print quality problems

Problem	Cause / action
<p>Light or blurred characters.</p> 	<p>Light print See “Light print” on page 2-50.</p> <p>The toner cartridge may be getting low on toner:</p> <ul style="list-style-type: none"> • Remove the toner cartridge and print cartridge assembly. • Shake it from side to side to redistribute the toner. • Reinstall it, and recheck for condition. • Make sure to use the recommended print media (see media types and sizes in the <i>User’s Guide</i>). • Use MarkVision™ Professional to define the custom type setting for media type, media texture, or media weight. • The toner cartridge or PC Kit may be defective. Replace the PC Kit first, and recheck. <p>Blurred characters Blurred images, including characters, are usually caused by a defective printhead.</p> <p>Vertical white lines See “Vertical streaks below.</p> <p>Vertical white lines may be caused by the laser beam, which may be partially blocked. With the printer off, clear the path or clean the lens. The toner cartridge or fuser may be defective. Try a different toner cartridge. Inspect the fuser at its entry for debris.</p>
<p>Toner smudges appear on the front or back of the page.</p> 	<ul style="list-style-type: none"> • Make sure the media is straight and unwrinkled. • Replace the PC Kit, and recheck before replacing the toner cartridge. See “Toner on back of page” on page 2-50 for more information.
<p>Vertical or horizontal streaks appear on the page</p> 	<p>Vertical streaks Something could be caught between the PC kit and the fuser. Check the paper path around the fuser entry. Try a different toner cartridge.</p> <p>Vertical white lines may be caused by the laser beam, which may be partially blocked. With the printer off, clear the path or clean the lens. The toner cartridge or fuser may be defective. Try a different toner cartridge. Inspect the fuser at its entry for debris.</p> <p>Horizontal streaks The toner cartridge or the fuser may be the cause due to excessive page count or defect. Replace as needed.</p> <p>If the lines are parallel and match the two intended ghost images, then the Form Type may be incorrectly set. Check those settings.</p> <p>The PC cleaner sump may be full. Replace the PC kit.</p>

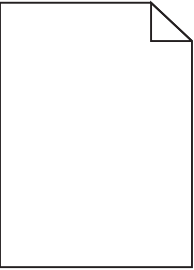
Print quality problems (Continued)

Problem	Cause / action
<p>Toner smears or rubs off the page.</p> 	<ul style="list-style-type: none"> • Toner is not being fused to the paper. Replace the fuser. • Change the media texture setting in the driver. If special media is being used, such as card stock or labels, then be sure to select the correct media type. • Try a different kind of paper. Paper designed for copiers gives the best quality fusing.
<p>The print is getting light, but the printer has not indicated it is low on toner.</p>	<ul style="list-style-type: none"> • Toner is becoming low in the cartridge. • The Toner Low message does not display if the 1,500-page toner cartridge is installed. • Remove the toner cartridge, and gently shake it from side to side to redistribute the toner. • Replace the toner cartridge.
<p>The Toner Low message displays.</p>	<ul style="list-style-type: none"> • Remove the toner cartridge, and gently shake it from side to side to redistribute the toner. • Replace the toner cartridge.
<p>Solid black areas on transparencies</p>	<ul style="list-style-type: none"> • There is a mismatch in the transparency and what the software is expecting. • Choose a different fill pattern in the software program. • Remove the toner cartridge, and gently shake it from side to side to redistribute the toner. • Try a different type of transparency. • Replace the toner cartridge.
<p>Faint images or repetitive spots appear on the page.</p>	<ul style="list-style-type: none"> • Select a different media type or form type setting from the printer driver. • Try a different type of paper. Media designed for copiers gives the best quality. • Replace the toner cartridge.
<p>Pages are blank.</p> 	<ul style="list-style-type: none"> • The print cartridge may be out of toner or defective. Replace the cartridge. • There may be a software error. Re-initialize the printer by turning it off and back on. • With the printer off, check the printhead beam path. If clear, then check for a printhead error on POR. See “Printhead service check” on page 2-54. • Also, see “Blank page” on page 2-47.

Print quality problems (Continued)

Problem	Cause / action
The printer is on and indicates ready, but nothing prints.	<ul style="list-style-type: none"> • Make sure the parallel or USB cable is not damaged and is firmly plugged into the connector on the back of the printer. • Make sure the toner cartridge assembly is installed properly. • Print the menu page using the Menu Settings Page in the Reports Menu. <ul style="list-style-type: none"> - If a menu settings page cannot be printed, then contact the next level of support. - If a menu settings page can be printed, then the problem is one of the following: <ul style="list-style-type: none"> • Computer • Software program • Cable • (USB only) A failed controller board. Replace card. <p>Note: Test by unplugging USB and plugging it with the printer on. If the computer indicates "unknown device," then replace the controller board.</p>
Toner Low light is on and printing stops.	If a 3.5K or more page toner cartridge is being used and the Toner Low alarm is set to on, then the printer stops printing until the toner cartridge is replaced.
The Error light alone is on.	Make sure the front printer cover is closed.
The Toner Low light is blinking, and the Error light is on.	<ul style="list-style-type: none"> • Make sure the toner cartridge is installed correctly. • Install a new toner cartridge.
The media skews or buckles.	<ul style="list-style-type: none"> • Tray is overfilled or media is too loose. • Don't overfill Tray 1 or the optional Tray 2 (see media capacities in the media types and sizes table in the <i>User's Guide</i>). • Make sure the paper guides are flush against the edges of the media.
The media sticks together, resulting in the printer feeding multiple sheets.	<ul style="list-style-type: none"> • The friction between sheets is too high. • Remove the media from Tray 1 or Tray 2, and fan it. • Don't overfill Tray 1 or the optional Tray 2 (see media capacities in the media types and sizes chart in the <i>User's Reference</i>).
The media fails to feed from Tray 1.	<ul style="list-style-type: none"> • Frictional force between tires and media is less than resisting force. • Remove the media from Tray 1, and fan it. • Make sure Tray 1 is selected from the printer driver. Do not overfill the tray. • Check the condition of the rubber on the paper feed rolls. Replace if worn or contaminated. • Verify that the ACM clutch is functioning correctly.
The media fails to feed from the optional Tray 2.	<ul style="list-style-type: none"> • Incorrect tray selection or inadequate picking force by tires. • Make sure the correct tray and media type are selected from the driver. • Make sure the tray is pushed all the way in. • Remove the media from the optional Tray 2, fan it, and reload. • Check the rubber on the paper feed tires for dirt or any other debris. Replace as necessary. • Check the paper path in the tray for burrs or debris that may hinder media movement. • Make sure the media does not exceed the stack height indicator.
Load Paper displays even though there is media loaded in the optional Tray 2.	<ul style="list-style-type: none"> • The input sensor does not sense media after picking. • Make sure the tray is pushed all the way in. • Press . • Check the feed tires. (See two preceding actions.)
The printer does not print after a paper jam has been cleared.	<ul style="list-style-type: none"> • The printer is waiting on the next command. • Clear all jams. • Press and release , or open and close the printer cover to restart the printer. • Make sure the print cartridge assembly is installed properly.

Print quality problems (Continued)

Problem	Cause / action
Unexpected characters print, or characters are missing.	<ul style="list-style-type: none"> • Ensure correct printer driver is being used. • Select hex trace mode to determine what the problem is. • Restore factory defaults. • Make sure the parallel cable or USB cable is firmly plugged in at the back of the printer.
Jobs are not printing, and an error message is displayed.	<ul style="list-style-type: none"> • The printer is waiting for an appropriate command. • Make sure the print cartridge assembly is installed properly. • Make sure the printer front cover is closed.
While in PostScript 3 emulation, the printer is flushing data (an error message is displayed).	<ul style="list-style-type: none"> • Ensure the correct PostScript driver is being used. • The printer doesn't have enough memory to print the job. Install more memory.

Printhead service check

FRU	Action
 <p>Printhead</p> <p>Note: New printhead must be aligned. See “Printhead assembly electronic adjustment” on page 3-38</p>	<p>Turn the printer off.</p> <p>Disconnect the printhead cables from J9 and J6 on the controller board.</p> <p>Turn the printer on with the front door closed.</p> <p>On the controller board, verify +5 V dc on pins 2 and 3 at J6 and +5 V dc on pins 1, and 10 at J9.</p> <p>Verify grounds on pins 4, 5, 6, and 7 at J6 and on pin 4 at J9.</p> <ul style="list-style-type: none"> • If voltages or grounds are incorrect, then check the controller board. See “Controller board service check” on page 2-35 for more information. • If voltages are correct, then replace the printhead. • If the printhead cables are faulty, order cable parts 40X5816 (HSYNC cable) and 40X5817 (LSU diode cable).

Transfer roll service check

FRU	Action
 <p>Transfer roll</p>	<p>Note: Do not touch the transfer roll except at its ends. Place a sheet of paper over the roll to prevent damage from finger oils or hand lotion.</p> <p>Check the springs in the left and right transfer roll bearings. Do not try to move the left spring. The bearing assemblies should support the transfer roll, applying evenly distributed forces to the PC drum.</p> <p>Replace the transfer roll assembly if the springs or bearings show signs of damage, or fatigue.</p> <p>Inspect the transfer roll for signs of wear, damage or contamination.</p> <p>Replace as necessary.</p>

Tray 2 service check

FRU	Action
Tray 2	<p>Turn the printer off.</p> <p>Separate the printer from Tray 2.</p> <p>Turn the printer on and check the voltages on connector J28 on the engine board.</p> <p>Pins 1, 4: 3.3 V</p> <p>Pin 2: 24 V</p> <p>Pin 6: Ground</p> <p>If the voltages are incorrect, then replace the engine board. If the voltages are correct, then try using Tray 2 again. If the printer error persists, then replace Tray 2.</p>

840.xx service check

Step	Questions / actions	Yes	No
1	<p>POR the machine into configuration mode. Go to the disable scanner menu item. See “Disable Scanner” on page 3-9. Touch “Enable ADF/FB -Enabled and press Submit to save the change. POR the MFP to operating mode. Try running a copy from the ADF and flatbed.</p> <p>Did the 840.xx error recur?</p>	Go to step 2.	Stop. Problem resolved.
2	<p>Re-enter Configuration mode, scroll to and select the Disable Scanner menu item.</p> <p>Does the screen display ADF Disabled or Auto Disabled?</p>	Go to step 3.	Go to step 8.
3	<p>Check the ADF cable connections on the ADF relay card and connector J17 on the controller board. Also inspect the cable connections on J28, J12, 13 and J30 on the controller board.</p> <p>Are the connections properly connected?</p>	Go to step 5.	Go to step 4.
4	<p>Properly connect the connections on the ADF relay card and controller board. POR the machine into configuration mode. Go to the disable scanner menu item. See “Disable Scanner” on page 3-9. Touch “Enable ADF/FB -Enabled and press Submit to save the change. POR the MFP to operating mode. Try running a copy from the ADF and flatbed.</p> <p>Did the 840.xx error recur?</p>	Go to step 5.	Stop. Problem solved.
5	<p>Check the continuity on the ADF cable.</p> <p>Is there continuity?</p>	Go to step 7	Go to step 6.

Step	Questions / actions	Yes	No
6	<p>Replace the ADF cable. POR the machine into configuration mode. Go to the disable scanner menu item. See “Disable Scanner” on page 3-9. Touch “Enable ADF/FB -Enabled and press Submit to save the change. POR the MFP to operating mode. Try running a copy from the ADF and flatbed.</p> <p>Did the 840.xx error recur?</p>	Go to step 7.	Stop. Problem solved.
7	<p>Replace the ADF unit. See “ADF unit removal” on page 4-88. POR the machine into configuration mode. Go to the disable scanner menu item. See “Disable Scanner” on page 3-9. Touch “Enable ADF/FB -Enabled and press Submit to save the change. POR the MFP to operating mode. Run a copy from the ADF.</p> <p>Did the 840.xx error recur?</p>	Go to step 8.	Stop. Problem solved.
8	<p>Inspect J17, J12, 13 and J30 on the controller board.</p> <p>Are the connections properly connected?</p>	Go to step 10.	Go to step 9.
9	<p>Properly connect all the connections.</p> <p>Did the 840.xx error recur?</p>	Go to step 10.	Stop Problem solved.
10	<p>Replace the flatbed unit. See “Flatbed removal” on page 4-89. POR the machine into configuration mode. Go to the disable scanner menu item. See “Disable Scanner” on page 3-9. Touch “Enable ADF/FB -Enabled and press Submit to save the change. POR the MFP to operating mode. Run a copy from the flatbed.</p> <p>Did the 840.xx error recur?</p>	Go to step 11	Stop. Problem solved.
11	<p>Replace the controller board. See “Controller board removal” on page 4-8.</p> <p>Did this fix the problem?</p>	Problem solved.	Contact second-level support.

Black or blank page copy service check

Step	Questions / actions	Yes	No
1	Print a menu page, or a page from the host. Is the page black?	See “Black page” on page 2-48	Go to step 2.
2	Is the copy an ADF scan?	Go to step 4.	Go to step 3.
3	Run a flat bed copy. Is it blank or black?	Go to step 5	Go to step 4
4	Did the sheet feed into the ADF?	Go to step 6.	Go to step 5.
5	Is the CCD ribbon cable properly connected to J30 on the controller board?	Go to step 6.	Properly connect the ribbon cable to J30.
6	Check for +14VDC on Pin 3 and 4 on connector J30. Pin 4 is +5VDC. Are the voltages present?	Replace the flatbed unit. See “Flatbed removal” on page 4-89.	Replace the controller board. See “Controller board removal” on page 4-8.

CCD service check

Step	Questions / actions	Yes	No
1	Restart the device, and retry the scan / copy job. Repeat this step with a few copy jobs. Does the error return?	Go to step 2.	No issue.
2	Is the CCD ribbon cable properly connected to J30 on the controller board?	Go to step 3.	Properly connect the ribbon cable to J30.
3	Replace the flatbed unit. See “Flatbed removal” on page 4-89. Did this resolve the issue?	Problem resolved.	Replace the controller board. See “Controller board removal” on page 4-8.

Flatbed motor service check

Step	Questions / actions	Yes	No
1	Ensure that the flatbed motor cable (J28) is connected to the controller board. Is the cable connected?	Go to step 2.	Properly connect the cable.
2	Check pin 1 in J28 for voltage. The voltage is only present when a flatbed copy job is running. The voltage should measure +24V AC. Is voltage present?	Replace the flatbed unit. See “Flatbed removal” on page 4-89.	Replace the controller board. “Controller board removal” on page 4-8.

Flatbed home position service check

Step	Questions / actions	Yes	No
1	POR the MFP. Does the CCD move and return to the home position?	Problem solved.	Go to step 2.
2	Perform the home position sensor test. Go to “Scanner Tests” on page 3-34. Is the sensor working properly?	Go to step 3.	Go to step 5.
3	Check J28 on the controller board for proper connection. Is it connected properly?	Go to step 4.	Properly connect the cable.
4	Check pin 1 in J28 for voltage. The voltage is only present when a flatbed copy job is running. The voltage should measure +24V AC. Is voltage present?	Go to step 5.	Replace the controller board. “Controller board removal” on page 4-8
5	Ensure that the home position cable (J13) is connected. Is the cable connected?	Go to step 6.	Properly connect the cable.
6	Check pin 1 in J13 for voltage. The voltage should measure +5V DC. Pin 2 should be GND. Is voltage present and is it correct?	Replace the flatbed unit. See “Flatbed removal” on page 4-89.	Replace the controller board. “Controller board removal” on page 4-8.

ADF cover open service check

Step	Questions / actions	Yes	No
1	Is the ADF cover properly closed	Go to step 3.	Go to step 2.
2	Close the ADF cover. Does the problem go away?	Issue resolved	Go to step 3.
3	Perform the ADF cover open sensor test. Go to "Scanner Tests" on page 3-34. Does the sensor work properly.	Go to step 4	Go to step 8.
4	On the bottom of the ADF cover, inspect the ADF cover closed sensor actuator. Does it move freely?	Go to step 6.	Go to step 5.
5	Fix the actuator so it moves freely. Does this fix the problem?	Issue resolved.	Go to step 6.
6	Remove the ADF rear cover and inspect the ADF cover closed sensor for dirt and debris. Is there dirt and debris present?	Go to step 7.	Go to step 8.
7	Remove the ADF rear cover, and clean the dirt and debris from the sensor. Does this fix the issue?	Issue resolved.	Go to step 8.
8	Inspect the connections on the ADF relay card in the ADF. Are all the connections properly connected?	Go to step 9.	Secure all the connections.
9	Check the ADF cable for continuity. Is there continuity?	Go to step 10.	Replace the ADF cable. See "ADF cable removal" on page 4-102.
10	Check for signals or voltages from J17 on the controller board. Pin 11 and 12 should measure +24VDC. Pin 14 should measure +5VDC. Are there signals or voltages present?	Replace the ADF. See "ADF unit removal" on page 4-88.	Replace the controller board. See "Controller board removal" on page 4-8.

ADF streak service check

Step	Questions / actions	Yes	No
1	Do streaks appear on the middle of scans when using the ADF?	Clean the ADF glass on the flatbed using a lint-free cloth. Kit 40X0392 is available for cleaning the glass on the flatbed. Also, clean the separator roll and pad with a damp cloth.	No issue to fix.

ADF paper jam service check

Note: This service check should be used if the paper feeds and jams in the ADF. If the paper is not feeding into the ADF see **“ADF feed errors service check” on page 2-60.**

Step	Questions / actions	Yes	No
1	If the ADF is multi-feeding, check for dirt on the ADF separator pad and ADF separator rollers. Are they dirty?	Clean them with a lint free cloth and isopropyl alcohol.	Replace the separator pad and ADF pick roll.
2	If the paper is skewing when it is fed into the ADF, check the paper guide width. Is it set correctly?	Go to step 3.	Set the paper guides so they contact the edges of the paper.
3	If paper is skewing when fed or jamming check to see if the top cover is open or ajar. Is the ADF top cover open or ajar?	Properly close the top cover.	If the paper is jamming in the ADF, go to step 6
4	Is paper failing to feed into the ADF?	Go to step 5.	There is no issue.
	Perform the ADF paper present, scan 1st and scan 2nd sensor tests. Go to “Scanner Tests” on page 3-34. Are the sensors working properly.	Go to step 6	Go to step 9.
6	Check the leading edge of the paper to ensure the paper is not curled or bent in a way that would keep it from contacting the paper present sensor actuator. Is the paper damaged?	Bad media.	Go to step 7.
7	Is there dirt in the sensors, or is the paper present actuator stuck?	Clean the sensors, or remove debris from the actuators.	Go to step 8.
8	Are the sensor actuators on the ADF mechanism cover damaged?	Replace the ADF.	Go to step 9.
9	Is the ADF connector properly connected to J17 on the system board?	Go to step 10.	Properly connect the cable to the system board.
10	Inspect the connections on the ADF relay card in the ADF. Are all the connections properly connected?	Go to step 11.	Secure all the connections.
11	Check the ADF cable for continuity. Is there continuity?	Go to step 11.	Replace the ADF cable.
11	Check for signals or voltages from J17 on the controller board. Pin 11 and 12 should measure +24VDC. Pin 14 should measure +5VDC. Are there signals or voltages present?	Replace the ADF unit. See “ADF unit removal” on page 4-88.	Replace the controller board. See “Controller board removal” on page 4-8.

ADF feed errors service check

Step	Questions / actions	Yes	No
------	---------------------	-----	----

1	If the ADF is multi-feeding, check for dirt on the ADF separator pad and ADF separator rollers. Are they dirty?	Clean them with a lint free cloth and isopropyl alcohol.	Replace the separator pad and ADF pick roll.
2	If the paper is skewing when it is fed into the ADF, check the paper guide width. Is it set correctly?	Go to step 3.	Set the paper guides so they contact the edges of the paper.
3	If paper is skewing when fed or jamming check to see if the top cover is open or ajar. Is the ADF top cover open or ajar?	Properly close the top cover.	If the paper is jamming in the ADF, See “ADF paper jam service check” on page 2-60
4	Is paper failing to feed into the ADF?	Go to step 5.	There is no issue.
5	Is the leading edge of the paper wrinkled or torn?	Use different media.	Go to step 6
6	Perform the ADF paper present sensor test. Go to “Scanner Tests” on page 3-34. Is the sensor working properly?	Go to step 7.	Properly connect all the connections in the ADF relay card.
7	Check the actuators to see if they are jammed, or damaged. Are they jammed or damaged?	Replace the ADF. See “ADF unit removal” on page 4-88.	Go to step 8.
8	Properly connect all the connections in the ADF relay card and controller board. Did this fix the situation?	Problem resolved	Go to step 9.
9	Check the ADF cable for continuity.	Go to step 6.	Replace the ADF cable. Go to “ADF cable removal” on page 4-102
10	Replace the ADF. See “ADF unit removal” on page 4-88. Does this fix the situation?	Problem solved	Replace the controller board. Go to “Controller board removal” on page 4-8.

ADF Duplex service check

Step	Questions / actions	Yes	No
1	Perform sensor 1, and sensor 2 sensor tests. Go to “Scanner Tests” on page 3-34. Are the sensors working properly?	Go to step 2.	Go to step 3.
2	Check the ADF sensor actuators to see if they are dirty or jamming. Are the actuators ok?	Go to step 3.	Clean the actuators. If any actuators on the ADF are broken, replace the ADF unit. Go to “ADF unit removal” on page 4-88.
3	Check all the connections on the ADF relay card. Are they properly connected?	Go to step 4	Properly connect all the connections.
4	Check the ADF cable to ensure it is properly connected to CN 15 on the ADF relay card, and main controller board at J17. Is the ADF cable properly connected?	Go to step 5.	Properly connect the ADF cable to its connections.
5	Check the ADF cable for continuity. Make sure pin 22 has continuity. Is there continuity on pin 22?	Go to step 6.	Replace the ADF cable. Go to “ADF cable removal” on page 4-102.
6	Replace the ADF. Go to “ADF unit removal” on page 4-88. Does this fix the situation?	Problem solved	Replace the controller board. Go to “Controller board removal” on page 4-8.

Modem / fax card service check

Step	Questions / actions	Yes	No
1	Is the phone line properly connected to the modem card and the wall jack?	Go to step 3.	Go to step 2.
2	Properly connect the phone line to the modem card and wall jack. Did this fix the problem?	Problem resolved.	Go to step 3.
3	Test the phone line's ability to send and receive calls. Did the phone line work properly?	Go to step 5.	Go to step 4.
4	Use the MFP on a properly functioning phone jack. Did this fix the problem?	Problem resolved.	Go to step 5.
5	Is the modem card cable properly connected to the system board at J8 and the modem card?	Go to step 7.	Go to step 6.
6	Properly connect the modem card cable to the modem card and system board. Did this fix the problem?	Problem resolved.	Go to step 7.
7	Check the modem card cable for continuity. Is there continuity?	Go to step 8.	Replace the modem card cable.
8	Check the voltages from connector J8 on the controller board. Check Pin 12 and 13 for +3.3VDC, Pin 10 for +5VDC. 2, 4, 6, and 8 are grounds. Are the signals or voltages present?	Replace the modem card.	Replace the controller board. See " Controller board removal " on page 4-8.

Fax transmission service check

Note: Before performing this service check, verify that the correct country code for the MFP is selected. This setting must match the country in which the MFP is used to transmit and receive faxes. If the setting is wrong, the modem settings can be changed in the Fax/SE menu. See step 14. These settings should only be performed with guidance from your second-level support.

Step	Questions / actions	Yes	No
1	Is the phone line properly connected to the modem card and the wall jack?	Go to step 3.	Go to step 2.
2	Properly connect the phone line to the modem card and wall jack. Did this fix the problem?	Problem resolved	Go to step 3.
3	Test the phone line's ability to send and receive calls. Did the phone line work properly?	Go to step 5.	Go to step 4.
4	Use the MFP on a properly functioning phone jack. Did this fix the problem?	Problem resolved.	Go to step 5.
5	Is the phone line being used by the MFP an analog line?	Go to step 8.	Go to step 6.
6	Is the line being used a VOIP line?	Go to step 7.	Go to step 8.
7	Have the system administrator verify that the VOIP server is configured to receive faxes. Is the server properly configured?	Go to step 8.	Stop here. The issue is VOIP related. The VOIP provider needs to change the server configuration.
8	Is the MFP on a PABX?	Go to step 9.	Go to step 10.
9	Enable Behind a PABX under fax settings in the Administration menu. Did this fix the issue?	Problem fixed.	Disable Behind a PABX , and go to step 10.
10	Is a dial prefix needed to get an outside line?	Go to step 11.	Go to step 12.
11	Try sending a fax using a dial prefix. Did the fax transmit?	Problem fixed.	Go to step 12.
12	Is the fax failing to send to one specific destination?	Go to step 13.	Go to step 14.
13	Check the device that cannot receive a fax. Can it send a fax?	Go to step 14.	Stop here. The issue is with the other device.
14	Press **411 to enter the Fax/SE Menu. Select "Print Logs". Print the T30 transmission log. Check the error being reported with the fax error code table. See " Fax error codes " on page 2-31 . Perform the suggested resolution for the error. Did this fix the problem?	Problem resolved.	Go to step 15.

Step	Questions / actions	Yes	No
15	<p>Adjust the "Transmit Level" setting in the SE menu. Press **411 to enter the SE menu, enter Modem settings, and select "Transmit Level".</p> <p>Test by adjusting the transmitted signal strength by decreasing/increasing the 'Transmit Level' setting in steps of 1db. For example, if default value is -11 db, changing it to -12db will decrease the signal strength by 1db, and changing it to -10db will increase the signal strength by 1db. Recommended adjustment range is ± 5 db (in 1db steps) from the default value.</p> <p>Did this fix the problem?</p>	Stop. Problem resolved.	Go to your second-level of support. See "Escalating a fax issue to second-level support" on page 2-68.

Fax reception service check

Step	Questions / actions	Yes	No
1	Is the phone line properly connected to the modem card and the wall jack?	Go to step 3.	Go to step 2.
2	Properly connect the phone line to the modem card and wall jack. Did this fix the problem?	Problem resolved.	Go to step 3.
3	Check for a dial tone. Is there a dial tone?	Go to step 4.	Go to step 6.
4	Use a telephone to test the phone line's ability to send and receive calls. Did the phone line work properly?	Go to 7.	Go to step 5.
5	Use a telephone handset to verify the phone line is free of static or external noise. Is the phone line noise-free?	Go to step 7.	Go to step 6.
6	Use the MFP on a properly functioning phone jack. Did this fix the problem?	Problem resolved.	Go to step 7.
7	In <diags / config menu>, verify that the Enable Fax Receive setting is on. Is the setting set to on?	Go to step 9.	Go to step 8.
8	Set "Enable Fax Receive" to On. Did this fix the problem?	Problem resolved.	Go to step 9.
9	Is Distinctive Ring enabled?	Go to step 11.	Go to step 10.
10	Turn on Distinctive ring. Did this fix the problem?	Problem resolved.	Go to step 11.
11	Is the phone line analog?	Go to step 13.	Go to step 12.
12	Is the VOIP server configured to support fax?	Go to step 13.	Stop here. This is an issue with the VOIP provider.
13	Does the MFP have reception issues with only a certain remote device?	Go to step 14.	Go to step 15.
14	Verify communications with a different remote device. Can the other device receive faxes?	The issue is with the other device.	Go to step 15.
15	Go to the Administrator menu. Enter the Fax settings - Analog Fax Settings submenu. Verify the Block No Name Fax user setting. Is it enabled?	Go to step 16.	Go to step 17.
16	Disable Block No Name Fax user setting. Did this fix the issue?	Problem resolved.	Go to step 17.

Step	Questions / actions	Yes	No
17	<p>Go to the Administrator menu. Enter the Fax settings - Analog Fax Settings submenu.</p> <p>Verify the remote device number is not in the Banned Fax List user setting.</p> <p>Is the remote device number in the banned fax list?</p>	Go to step 18.	Go to step 19.
18	<p>Remove the remote number from the banned fax list.</p> <p>Did this fix the problem?</p>	Problem resolved.	Go to step 19.
19	<p>Adjust the "Receive Threshold" setting in the SE menu. press **411 to enter the SE menu, enter Modem settings, and select "Receive Threshold".</p> <p>Test by adjusting the received signal level by decreasing/increasing the "Receive Threshold" setting in steps of 2db. For example, if default value is -43 db, changing it to -45db will decrease the received signal level by 2db, and changing it to -41db will increase the received signal level by 2db. Recommended adjustment range is between -33db and -48db (in 2db steps).</p> <p>Did this fix the problem?</p>	Problem resolved	Go to step 20.
20	<p>Press **411 to enter the SE Menu. Select "Print Logs".</p> <p>Print the T30 transmission/ job log. Check the error code being reported. See "Fax error codes" on page 2-31. Perform the suggested resolution for the error.</p> <p>Did this fix the problem?</p>	Problem resolved.	<p>Contact your second-level of support. See "Escalating a fax issue to second-level support" on page 2-68.</p>

Escalating a fax issue to second-level support

Before contacting the second-level support, go to the SE menu on the MFP and generate a Fax error file. This file contains machine settings information and debug information that will help second-level support determine the cause of a failure.

To generate the fax error file, perform the following steps:

1. In a Web browser, type `http://MFP ip address/se`.
2. The MFP's SE menu page will display. Click the "Dump Job History" link. The following displays:

Fax Job Log							
Wednesday, 2006-02-08 11:25							
Action	Date	Time	Job #	Length	Station Name/Number	Pages	Status
SCAN	1969-12-31	19:00				9	OK
SEND	2006-02-01	13:55	73	17:53	4039	2	CANCELED
SEND	2006-02-01	13:56	74	17:53	4039	0	CANCELED

3. Write down the type of connection, the type of error, and the job in which the error occurred.
4. In the Web browser address bar, type `http://MFP ipaddress/se`.
5. Click **Report a Fax Problem (A)**. The fax check list displays.
6. Fill in the requested information. This is where you will type in the information you retrieved in step 3. Second-level support can assist you if you have questions about the information requested on the page.

Title/Name of Tester	<input type="text" value="Your Name"/>	Date of Event	<input type="text" value="Date of Event"/>	mm/dd/yyyy
Customer	<input type="text" value="Customer Name"/>	Time of Event	<input type="text" value="Time of Event"/>	hh:mm [A,P]M
Job ID	<input type="text" value="Job ID"/>	#		
Describe the Physical Connection:				
Type:	Description:	Channel Quality:		
<input checked="" type="radio"/> Analog	<input type="checkbox"/> VoIP/FoIP	<input checked="" type="radio"/> Clear		
<input type="radio"/> Digital	<input type="checkbox"/> PAB	<input type="radio"/> OK		
	<input type="checkbox"/> ISD	<input type="radio"/> Some Noise		
		<input type="radio"/> Very Noisy		

Note: The fields requesting the code levels, model number, type of problem are auto-filled. If the information is not in the fields, it can be retrieved from the SE menu. The SE menu can be accessed by pressing `**411` on the keypad or typing `http://MFP ipaddress/se` in a Web browser.

7. After all the requested information is entered into the Fax Checklist Web page, press the **Submit** button on the bottom of the page. A dialogue asking you to save the file will appear.

Note: The file generated by the MFP is not automatically transmitted to second-level support. It is placed on the computer desktop.

8. Enter a name for the file, and indicate where you want to save the file.
9. press **OK**. The file appears on the desktop.
10. E-mail the file to second-level support.

3. Diagnostic aids

This chapter explains the tests and procedures to identify printer failures and verify repairs have corrected the problem.

Accessing service menus

There are different test menus that can be accessed during POR to identify problems with the printer.

Configuration Menu	<ol style="list-style-type: none"> 1. Turn off the printer. 2. Press and hold 2 and 6. 3. Turn on the printer. 4. Release the buttons after 10 seconds. 	<p>The Configuration Menu group contains a set of menus, settings, and operations which are infrequently required by a user. Generally, the options made available in this menu group are used to configure a printer for operation.</p> <p>See “Configuration menu (CONFIG MENU)” on page 3-2 for more information.</p>
Diagnostics Mode	<ol style="list-style-type: none"> 1. Turn off the printer. 2. Press and hold 3 and 6. 3. Turn on the printer. 4. Release the buttons after 10 seconds. 	<p>The Diagnostics Mode group contains the settings and operations used while manufacturing and servicing the printer.</p> <p>See “Diagnostics menu” on page 3-17 for more information.</p>

To run the printer diagnostic tests described in this chapter, the printer must be in Diagnostic Mode.

Note: If you have installed a controller board, engine board, or operator panel as part of a troubleshooting procedure, start the machine into diagnostic mode to test the repair.

Configuration menu (CONFIG MENU)

Available menus

Maintenance Count Value	See “Maintenance Count Value (Maint Cnt Value)” on page 3-3.
Reset Maintenance Count	See “Reset Maintenance Counter” on page 3-3.
Reset Photoconductor Maintenance Count	See “Reset Photoconductor Maintenance Counter (Reset PC Cnt)” on page 3-4.
USB Scan to Local	See “USB Scan to Local” on page 3-4.
Print Quality Pages	See “Print Quality Pages” on page 3-4.
Reports	See “Reports” on page 3-32.
Panel Menus	See “Panel Menus” on page 3-4.
PPDS Emulation	See “PPDS Emulation” on page 3-5.
Download Emuls	See “Download Emuls” on page 3-5.
Factory Defaults	See “Factory Defaults” on page 3-6.
Energy Conserve	See “Jobs on Disk” on page 3-10.
Min Copy Memory	See “Min Copy Memory” on page 3-6.
Num Pad Job Assist	See “Num Pad Job Assist” on page 3-7.
Format Fax Storage	See “Format Fax Storage” on page 3-7.
Fax Storage Location	See “Fax Storage Location” on page 3-7.
ADF Edge Erase	See “ADF Edge Erase” on page 3-7.
FB Edge Erase	See “FB Edge Erase” on page 3-7.
Scanner Manual Registration	See “Scanner Manual Registration” on page 3-8.
Disable Scanner	See “Disable Scanner” on page 3-9.
Paper Prompts	See “Paper Prompts” on page 3-9.
Envelope Prompts	See “Envelope Prompts” on page 3-9.
Action for Prompts	See “Action For Prompts” on page 3-9.
Jobs On Disk	See “Jobs on Disk” on page 3-10.
Disk Encryption	See “Disk Encryption” on page 3-10.
Wipe Disk	See “Wipe Disk” on page 3-13.
Font Sharpening	See “Jobs on Disk” on page 3-10.
Require Standby	See “Require Standby” on page 3-14.
LES Applications	See “LES Applications” on page 3-15.
Key Repeat Initial Delay	See “Key Repeat Initial Delay” on page 3-15.
Key Repeat Rate	See “Key Repeat Rate” on page 3-15.
Wiper Message	See “Wiper Message” on page 3-15.
Clear Custom Status	See “Clear Custom Status” on page 3-16.
USB Speed	See “USB Speed” on page 3-16.
USB PnP	See “USB PnP” on page 3-16.
Exit Config Menu	See “Require Standby” on page 3-14.

Note: Menus may vary depending on the features and options of the printer.

Maintenance Count Value (Maint Cnt Value)

This setting enables you to view the current maintenance count value of each maintenance kit. After selecting this item, you can choose a specific kit in order to view its current maintenance count value. To return to the Configuration Menu, press **Back**. All other control panel keys are ignored.

When a kit's maintenance count value equals its kit size (150K for the ADF Kit), the device posts the appropriate "80 Scheduled Maintenance" IR and a status indicator to notify the user to schedule the appropriate maintenance on the device.

To view the Maintenance Counter Value, touch **Maintenance Counter Value** from the Configuration Menu.

The panel displays the current value of the maintenance counter as illustrated below:

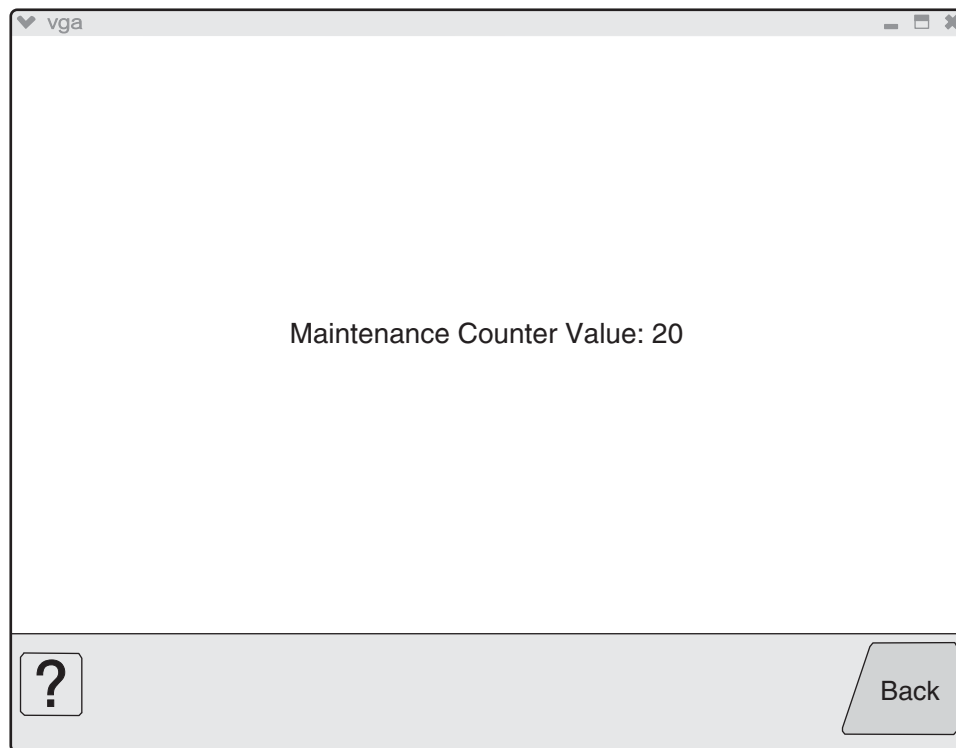

Touch **Back** to return to the Configuration Menu.

After installing the required maintenance kit, reset this count to zero.

Reset Maintenance Counter

After scheduled maintenance, reset the Maintenance Counter.

To reset the maintenance page counter to zero:

1. Touch **Reset Maintenance Counter** from the Configuration Menu.
2. **Reset Maintenance Counter** appears in the header.
3. Touch **100K Kit** or **600K Kit**. **Yes** and **No** appear in a menu.
4. To cancel the reset operation, touch **Back** or **No**. All other button presses are ignored.
5. To initiate the reset operation, touch **Yes**.

Reset Photoconductor Maintenance Counter (Reset PC Cnt)

This setting resets the photoconductor kit page counter and clears any warnings or photoconductor exhausted messages. This operation should be performed only after a new photoconductor unit has been installed.

USB Scan to Local

USB Scan to Local enumerates a USB simple device or USB composite device. In the off position the simple USB device is enumerated: in the on position, the composite USB device is enumerated.

To change this setting:

1. Touch **USB Scan to Local** from the Configuration Menu. ◀ [setting's current value] ▶ appears on the touch-screen.
2. Touch ◀ or ▶ to scroll through the setting's possible values.
3. Touch **Back** to cancel and return to the Configuration Menu.
4. Touch **Submit** to save the change.

Print Quality Pages

This setting is a limited version of the **Print Quality Pages** setting that appears in the **Diagnostics** menu. This setting reports the values of a broad range of printer settings and tests the printer's ability to generate acceptable printed output.



To print the Print Quality Pages:

1. Touch **Print Quality Pages** from the Configuration Menu. Printing Quality Test Pages... appears on the LCD.

Touch **Back** to return to the Configuration Menu.

The Reports menu contains two selections: Menu Settings Page and Event Log.

Menu Settings Page

To print the Menu Settings page, press . Press  to return to the Configuration menu.

Event Log

The event log provides a history of printer errors. The event log can only be printed in the Configuration menu. Additional options are available in the Diagnostics menu. See **“Reports” on page 3-32**.

To print the event log:

1. Select **Print Event Log** from the Event Log menu.
2. Press  to return to the Configuration menu.

Note: An event log printed from the CONFIG MENU will not contain debug information or secondary codes for 900 service errors. However, the event log printed from DIAGNOSTICS mode does include this information.

Panel Menus

Lets the system support person enable or disable the operator panel menus. Selecting **On** (the default) allows users to change values for the printer. **Off** disables the users' access to menus. If a user presses **Menu** , they receive a message that the panel menus are locked. When set to **Off**, this setting restricts all menu access, even to menus or items set for PIN access. However, when set to **On**, all PIN restrictions are restored.

To change the value of this setting:

1. Touch **Panel Menus** from the Configuration Menu. ◀ **[setting's current value]** ▶ appears on the touch-screen.
2. Touch ◀ or ▶ to scroll through the setting's other possible values.
3. Touch **Back** to cancel and return to the Configuration Menu.
4. Touch **Submit** to save the change.

PPDS Emulation

The value of the PPDS Emulation menu item determines if a device can recognize and use the PPDS datastream. The current value of this setting appears in parentheses to the right of the setting on the Configuration Menu screen.

The following table indicates how the value of this setting affects the user default value for the SmartSwitch and Printer Language settings:

Value of PPDS Emulation setting	Resulting value of SmartSwitch setting (all ports)	Resulting value for Printer Language settings
Activate	Off	PPDS Emulation Note: You can still switch languages on the operator panel or through the PJI ENTER LANGUAGE command.
Deactivate	On	Printer's factory default value

To change the value of this setting:

1. Touch **PPDS Emulation** from the Configuration Menu. ◀ **[setting's current value]** ▶ appears on the touch-screen.
2. Touch ◀ or ▶ to scroll through the setting's possible values.
3. Touch **Back** to cancel and return to the Configuration Menu.
4. Touch **Submit** to save the change.

Download Emuls

This setting enables you to disable a Downloadable emulator (DLE) that is installed on the MFP. The setting for this menu setting is disabled.

Note: The DLE is re-enabled automatically after two PORs.

To change the value of this setting:

1. Touch **Download Emuls** from the Configuration Menu. ◀ **[setting's current value]** ▶ appears on the touch-screen.
2. Touch ◀ or ▶ to scroll through the setting's possible values.
3. Touch **Back** to cancel and return to the Configuration Menu.
4. Touch **Submit** to save the change.

Factory Defaults

Warning: This operation cannot be undone.

This setting enables you to restore all of the printer's settings to the base printer settings, the network settings, or to remove all Lexmark Embedded Solutions (LES) applications.

To restore the Factory Default settings:

1. Touch **Factory Defaults** from the Configuration Menu.
2. Touch **Restore Base** to restore all non-critical base printer NVRAM settings.
3. Touch **Restore Network** to restore all network NVRAM settings.
4. Touch **Restore LES** to remove all Lexmark Embedded Solution applications.

When you select either value, the LCD displays Restoring Factory Defaults and then Resetting the Device. The device immediately performs a POR and restores the appropriate settings to their factory default values.

The following settings are not changed:

- Display Language (general settings)
- Network/Ports Menu
- Standard USB, USB (x) Menus (if an ENA is installed)

Energy Conserve

This menu controls what values appear on the Power Saver menu. If **Off** is selected in the Energy Conserve menu, then Disabled appears in the Power Saver menu, and Power Saver can be turned off. If **On** is set in the Energy Conserve menu, the Power Saver feature cannot be disabled.

To change this setting:

1. Touch **Energy Conserve** from the Configuration Menu. ◀ [setting's current value] ▶ appears on the touch-screen.
2. Touch ◀ or ▶ to scroll through the setting's possible values.
3. Touch **Back** to cancel and return to the Configuration Menu.
4. Touch **Submit** to save the change.

Min Copy Memory

Values will only be displayed if the amount of installed DRAM is at least twice the amount of the value, that is, at least 200 MB of installed DRAM is required to display the 100 MB selection.

To change this setting:

1. Touch **Min Copy Memory** from the Configuration Menu. ◀ [setting's current value] ▶ appears on the touch-screen.
2. Touch ◀ to decrease the setting's value; touch ▶ to increase the setting's value.
3. Touch **Back** to cancel and return to the Configuration Menu.
4. Touch **Submit** to save the change.

Num Pad Job Assist

This setting determines if a user can configure and initiate a job using the panels hard buttons.

To change this setting:

1. Touch **Num Pad Job Assist** from the Configuration Menu. ◀ **[setting's current value]** ▶ appears on the touch-screen.
2. Touch ◀ or ▶ . The settings are On or Off.
3. Touch **Submit** to save the change.

Format Fax Storage

This setting enables you to format the non-volatile storage used for storing faxes.

To change this setting:

1. Touch **Format Fax Storage** from the Configuration Menu.

Note: If an advanced password has been established, you must enter this password in order to change the setting. If no advanced password exists, you can establish one by using the keyboard that appears on the LCD.

2. Touch **Submit** to save the change.
3. Touch **Back** to cancel and return to the Configuration Menu.

Formatting Fax Flash DO NOT POWER OFF appears on the LCD while the format operation is active.

Fax Storage Location

To change this setting:

1. Touch **Fax Storage Location** from the Configuration Menu. ◀ **[setting's current value]** ▶ appears on the touch-screen.
2. Touch ◀ or ▶ . The settings are Disk and NAND.
3. Touch **Submit** to save the change.

ADF Edge Erase

This menu item sets the size, in millimeters, of the no-print area around an ADF scan job. All copy jobs have a minimum of a two millimeter border. Copy jobs will use the setting or two millimeters, whichever is larger.

To adjust the ADF edge erase setting, perform the following steps:

1. Touch **ADF Edge Erase** from the Configuration Menu. ◀ **[setting's current value]** ▶ appears on the touch-screen.
2. Touch ▶ to increase the value or ◀ to decrease the value.
3. Touch **Submit** to save the change.
4. Touch **Back** to cancel and return to the Configuration Menu.

FB Edge Erase

This menu item sets the size, in millimeters, of the no print area around a flatbed scan job. Copy jobs will use the setting or two millimeters, whichever is larger.

To adjust the flatbed edge erase setting, perform the following steps:

1. Touch **FB Edge Erase** from the Configuration Menu. ◀ **[setting's current value]** ▶ appears on the touch-screen.
2. Touch ▶ to increase the value or ◀ to decrease the value.
3. Touch **Submit** to save the change.
4. Touch **Back** to cancel and return to the Configuration Menu.

Scanner Manual Registration

This item is used to manually register the flatbed and ADF on the MFP's scanner unit. Registration should be performed whenever the ADF unit, flatbed unit, or controller card are replaced.

To manually register a Duplex ADF, perform the following steps:

1. In the Configuration Menu, scroll to the Scanner Manual Registration menu item.
2. Touch Scanner Manual Registration.
3. Touch the Print Quick Test Page menu item.
4. To view and adjust the duplex ADF front side registration, place the quick test page face up into the ADF.
5. Touch Copy Quick Test.
6. After the quick test page copies, touch ADF Front.
7. Use the ◀ or ▶ to increase or decrease the settings value for horizontal adjust and top margin.
Note: Each button press moves the margin values one pixel in the respective direction.
8. Press **Submit** to accept the value.
9. Verify the changes by placing the print quick test page face up and touching Copy Quick Test.
10. Repeat steps 6, 7, and 8 as needed.
11. To view and adjust the duplex ADF backside registration, place the quick test page face down up into the ADF, and touch Copy Quick Test.
12. After the quick test page copies, touch ADF Back.
13. Use the ◀ or ▶ to increase or decrease the settings value for horizontal adjust and top margin.
Note: Each button press moves the margin values one pixel in the respective direction.
14. Press **Submit** to accept the value.
15. Verify the changes by placing the print quick test page face down and touching Copy Quick Test.
16. Repeat steps 13, 14, and 15 as needed.

To manually register the flatbed, perform the following steps:

1. In the Configuration Menu, touch the Scanner Manual Registration menu item.
2. Touch the Print Quick Test Page menu item.
3. To view and adjust the flatbed registration, place the quick test page into the flatbed.
4. Touch the Copy Quick Test Page item.
5. After the quick test page copies, touch Flatbed.
6. Use the ◀ or ▶ to increase or decrease the settings value for the left or top margin.
Note: Each button press moves the margin values one pixel in the respective direction.
7. Touch **Submit** to accept the value.
8. Place the print quick test page on the flatbed and touch Copy Quick Test.
9. Repeat steps 5 and 6 as needed.

To exit REGISTRATION press **BACK**  or **STOP** .

Disable Scanner

This menu item is used to disable the MFP scanner if it is malfunctioning. The MFP must be powered off and on for the new settings to take effect.

To change this setting:

1. Touch **Disable Scanner** from the Configuration Menu.
2. Touch ◀ or ▶ to scroll through the setting's other possible values. The settings are Enable, Disable, ADF disable.
3. To save the setting's new value, touch **Submit**.

Paper Prompts

When a tray is out of the indicated paper size, a prompt is sent to the user to load paper in a tray. This setting controls the tray the user is directed to fill. Selections are Auto (default), MP Feeder, and Manual Paper.

To change this setting:

1. Touch **Paper Prompts** from the Configuration Menu. ◀ [setting's current value] ▶ appears on the touch-screen.
2. Touch ◀ or ▶ to scroll through the setting's other possible values.
3. To exit this screen without changing the setting's value, touch **Back**.
4. To save the setting's new value, touch **Submit**.

Envelope Prompts

This setting controls the tray the user is directed to refill when a specific envelope size is out. The selections are Auto (default), MP Feeder, and Manual Env.

To change the value of this setting:

1. Touch **Env Prompts** from the Configuration Menu. ◀ [setting's current value] ▶ appears on the touch-screen.
2. Touch ◀ or ▶ to scroll through the setting's possible values.
3. To exit this screen without changing the setting's value, touch **Back**.
4. To save the setting's new value, touch **Submit**.

Action For Prompts

This setting determines which input source receives paper-related or envelope-related change prompts when they occur.

To change the value of this setting:

1. Touch **Action for Prompts** from the Configuration Menu. ◀ [setting's current value] ▶ appears on the touch-screen.
2. Touch ◀ or ▶ to change the setting's value. The values are Prompt user, Continue, and Use current.
3. To save the setting's new value, touch **Submit**.

Jobs on Disk

Jobs On Disk allows you to delete buffered jobs saved on the disk.

To delete jobs saved on the disk:

1. Touch **Jobs On Disk** from the Configuration Menu.
2. Touch ◀ to decrease the setting's value; touch ▶ to increase the setting's value.
3. Touch **Back** to cancel and return to the Configuration Menu.

Disk Encryption

This setting determines if the printer encrypts the information that it writes to the hard disk. The values are Disable and Enable.

Warning: If the value is changed from **Enable** to **Disable** or from **Disable** to **Enable**, then the printer completely formats the hard disk. All information on the disk will be unrecoverable.

To change this setting:

1. Touch **Disk Encryption** from the Configuration Menu.

Note: If an advanced password has been established, you must enter this password in order to change the setting. If no advanced password exists, you can establish one by using the keyboard that appears on the LCD.

2. Touch **Submit** to save the change.
3. Touch **Back** to cancel and return to the Configuration Menu.

If you remove an encrypted disk from a device and then try to install another disk, Disk Corrupted. Reformat? appears on the LCD. You can format the newly installed disk or remove it from the device.

When you touch **Enable** (encryption) or **Disable** (formatting), Contents will be lost. Continue? appears on the LCD. Touch **No** to cancel or **Yes** to proceed. If you touch **Yes**, the printer performs the selected action on the hard disk. The following graphic appears when the encryption process is selected:

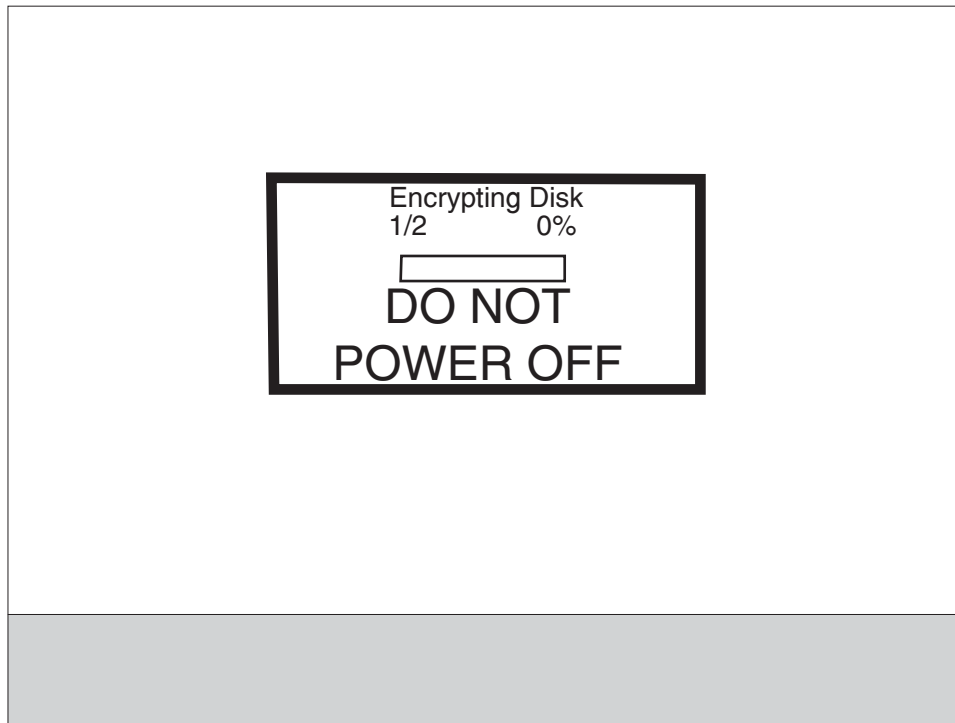

The following graphic appears when the formatting process is selected:

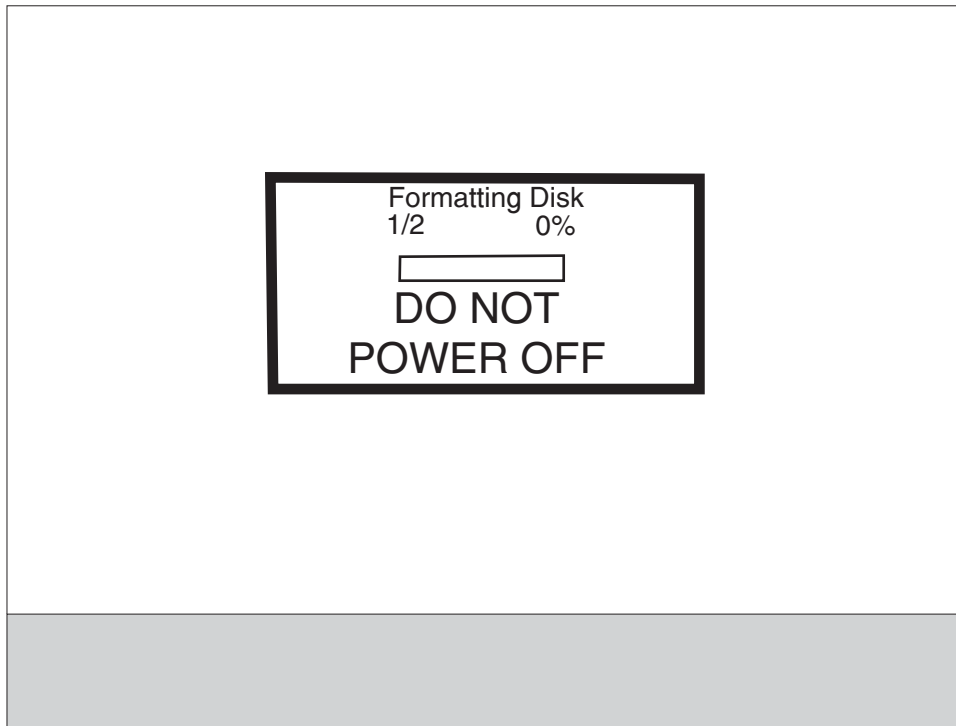

The panel provides many progress indicators during the two-stage process.

- **1/2** indicates that the process is currently in the first stage.
- **0%** indicates the progress of the current stage of the process.
- The progress bar indicates the overall completion of the entire process by filling in throughout each separate stage.

When the first stage of either process completes, the printer displays either of the following graphics depending on the process selected and then begins the second stage of the process:

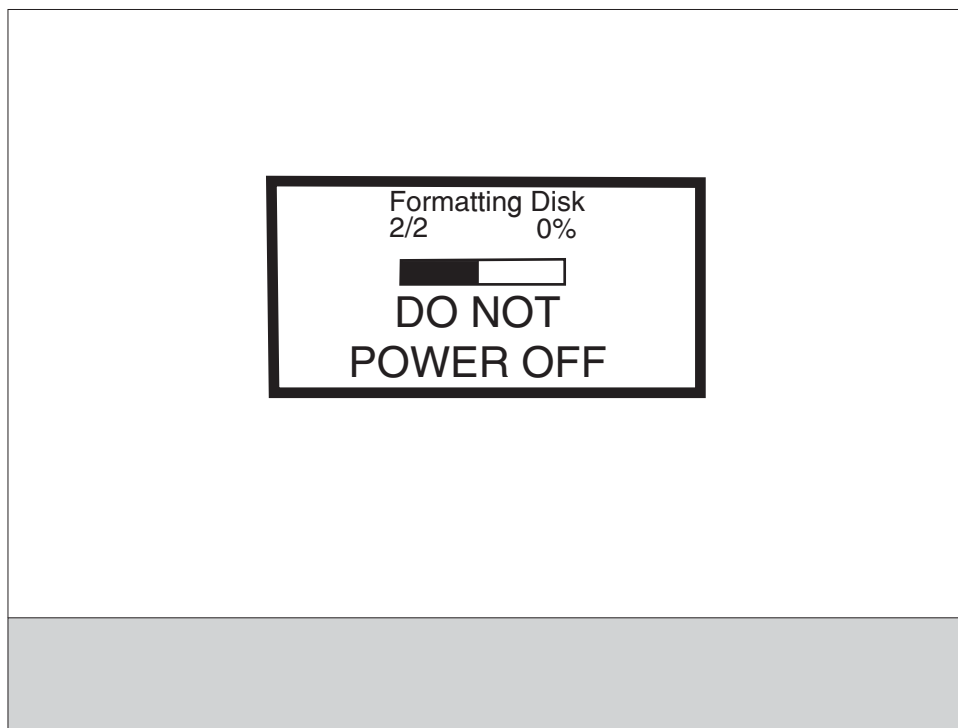
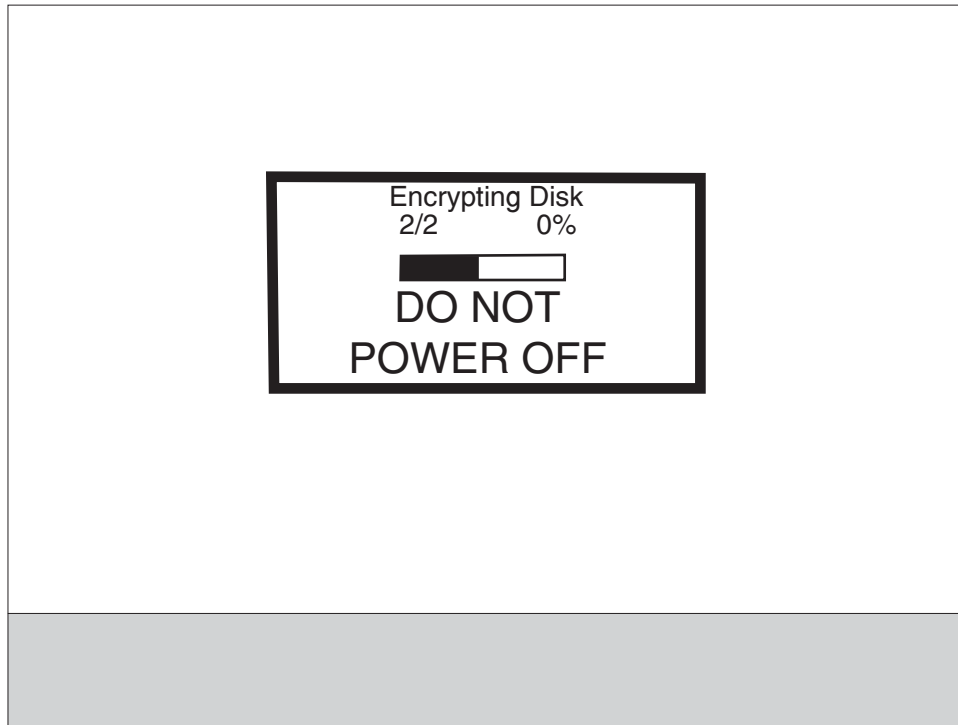

The entire process is complete when the progress bar appears completely shaded and the percentage indicator shows **100%**. After completion, the panel returns to Disk Encryption.

Wipe Disk

This setting provides you with a tool for erasing the contents of a disk.

Warning: Wipe Disk removes a disk's data in such a way that it cannot be recovered.

To change this setting:

1. Touch **Wipe Disk** from the Configuration Menu.

Note: If an advanced password has been established, you must enter this password in order to change the setting. If no advanced password exists, you can establish one by using the keyboard that appears on the LCD.

2. Touch **Wipe disk now**. Contents will be lost. Continue? appears on the LCD.
3. Touch **Back** to cancel and return to the Configuration Menu.

If you touch **No**, the device cancels the Wipe Disk process and returns to the Configuration Menu. If you touch **Yes**, the following screen appears:

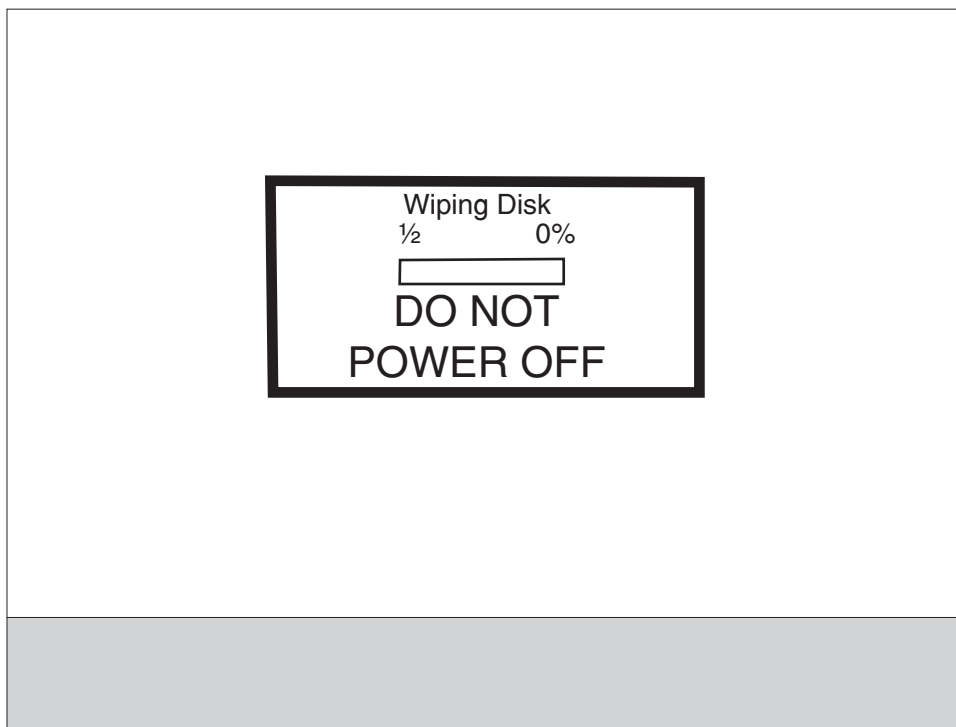

The panel provides the following progress indicators during the execution of this process:

1. **1/2** indicates that the process is currently in the first stage.
2. **0%** indicates the progress of the current stage of the process.
3. The progress bar indicates the overall completion of the entire process by filling in throughout each separate stage.

When the first stage of the process completes, the printer displays the following graphic and then begins the second stage of the process:

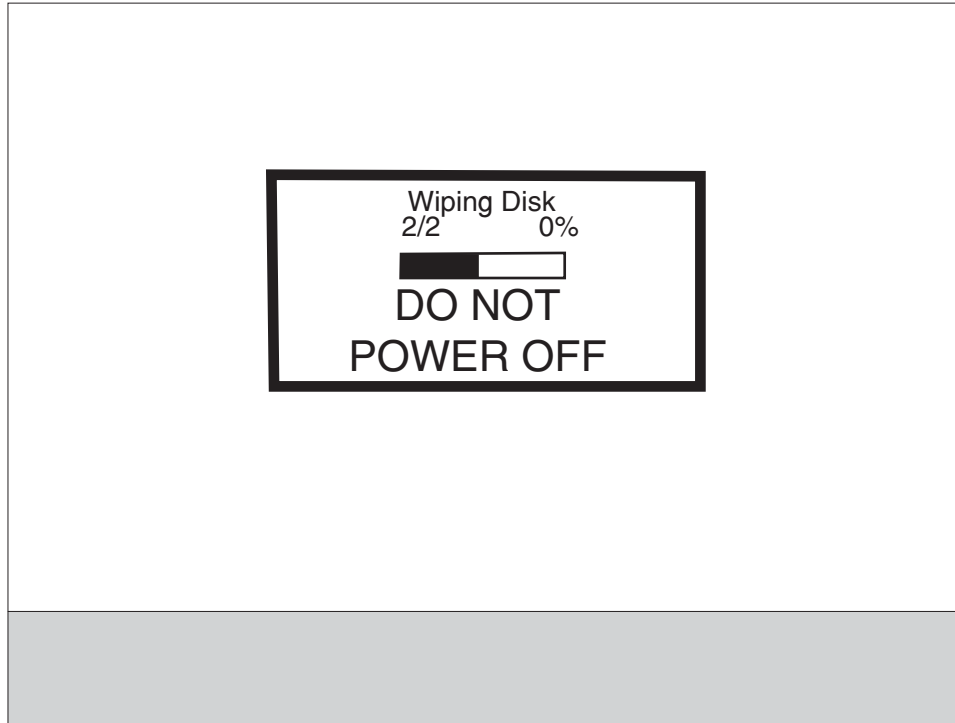

The entire process is complete when the progress bar appears completely shaded and the percentage indicator shows **100%**. The panel returns to the screen that shows the values for the Wipe Disk setting.

Font Sharpening

This setting allows you to set a text point size below which the high-frequency screens are used when printing font data. For example, at the default 24, all text in font sizes 24 and less will use the high frequency screens. The values for this setting range from 0 to 150.

To change this setting:

1. Touch **Font Sharpening** from the Configuration Menu.
2. Touch **▶** to increase the value or **◀** to decrease the value.
3. Touch **Back** to cancel and return to the Configuration Menu.
4. Touch **Submit** to save the change.

This setting affects the PostScript, PCL, PDF, and XL emulators.

This function is not supported when the device generates output at 600 dpi resolution.

Require Standby

This setting determines if the Standby Mode is **On** or **Off**. The default is **On**.

To change this setting:

1. Touch **Require Standby** from the Configuration Menu.
2. Touch **Back** to cancel and return to the Configuration Menu.
3. Touch **Submit** to save the change.

If Standby Mode is on, the printer begins functioning in Standby Mode when it remains idle for an amount of time. The Standby Mode enables the printer:

- To consume less energy than when operating in normal mode but not as little as when operating in Power Saver
- To return to the Ready state more quickly than when operating in Power Saver

LES Applications

This disables all installed Lexmark Embedded Solution applications. The default is **Enabled**.

To change this setting:

1. Touch **LES Applications** from the Configuration Menu.

Note: If an advanced password has been established, you must enter this password in order to change the setting. If no advanced password exists, you can establish one by using the keyboard that appears on the LCD.

2. Touch **Back** to cancel and return to the Configuration Menu.
3. Touch **Submit** to save the change.

Key Repeat Initial Delay

When a key is touched repeatedly, this is the delay before the key begins repeating. The delay ranges from .25 seconds to 5 seconds. The default is 1 second. Values are given in increments of .25 seconds.

To change this setting:

1. Touch **Key Repeat Initial Delay** from the Configuration Menu.
2. Touch **▶** to increase the value or **◀** to decrease the value.
3. Touch **Submit** to save the change.
4. Touch **Back** to cancel and return to the Configuration Menu.

Key Repeat Rate

This is the number of times per second that a repeating key will repeat. The range is 1–100, with a default of 15 times per second.

To change this setting:

1. Touch **⇒** to select **Key Repeat Initial Delay** from the Configuration Menu.
2. Touch **▶** to increase the value or **◀** to decrease the value.
3. Touch **Submit** to save the change.

Touch **Back** to cancel and return to the Configuration Menu.

Wiper Message

To change this setting:

1. Touch **⇒** to select **Wiper Message** from the Configuration Menu.
2. Touch **▶** or **◀** to change the value. The values are On (default) and Off.
3. Touch **Submit** to save the change.

Touch **Back** to cancel and return to the Configuration Menu.

Clear Custom Status

No values exist for this operation. Pressing initiates this operation.

Touch  to select **Clear Custom Status** from the Configuration Menu.

Note: Executing this operation erases any strings that have been defined by the user for the default or alternate custom messages.



USB Speed

USB PnP

This setting is used to improve the MFP's compatibility with the host PC.

Note: Some PCs contain chipsets that may be incompatible with this MFP.

To change this setting:

1. Touch  to select **USB PnP** from the Configuration Menu.
2. Touch  or  to change the value. The values are 1 (default) and 2.
3. Touch **Submit** to save the change.

Touch **Back** to cancel and return to the Configuration Menu.

Exit Configuration Menu (Exit Config Menu)

Press to exit the Configuration menu. The printer performs a POR and restarts in normal mode.

Diagnosics menu

Entering *Diagnosics* menu

1. Turn off the printer.
2. Press and hold 3 and 6.
3. Turn on the printer.
4. Release the buttons after ten seconds.

Available tests

The tests display on the operator panel in the order shown:

Registration	See “Registration (printer)” on page 3-18.
Print tests	See “Print Tests” on page 3-20.
Hardware tests	See “Hardware Tests” on page 3-21.
Duplex tests	See “Duplex Tests” on page 3-24.
Input Tray Tests	See “Input Tray Tests” on page 3-26.
Output Bin Tests	See “Output bin tests” on page 3-27.
Base Sensor Test	See “Base Sensor Test” on page 3-28.
Device Tests	See “DEVICE TESTS” on page 3-28
Printer setup	See “PRINTER SETUP” on page 3-29.
EP Setup	See “EP SETUP” on page 3-31.
Reports	See “Reports” on page 3-32.
Event Log	See “Reports” on page 3-32.
Scanner Tests	See “Scanner Tests” on page 3-34
Exit Diagnostics	See “Exit Diagnostics” on page 3-37.

Note: Menus may vary depending on the features and options of the printer.

Registration (printer)

Print registration makes sure the printing is properly aligned on the page.

REGISTRATION

Top Margin	◀	0	▶	
Bottom Margin	▶	0	▶	
Left Margin	▶	0	▶	
Right Margin	▶	0	▶	

Quick Test
▶

Submit
Back
▶

The settings available are:

Description	Value	Direction of change
Top Margin	-25 to +25 Each increment causes approximately 4 pels shift (at 600 dpi).	A positive change moves the image down the page and increases the top margin. A negative change moves the image up and decreases the top margin.
Bottom Margin	-20 to +20 Each increment causes approximately 0.55 mm shift in the bottom margin.	A positive change compresses the image so it appears to move down the page, and a negative change moves the image up.
Left Margin	-25 to +25	A positive change moves the image right, and a negative change moves the image left. No compression occurs.
Right Margin	-10 to +10	A positive change moves the image right, and a negative change moves the image left.

To set print registration:



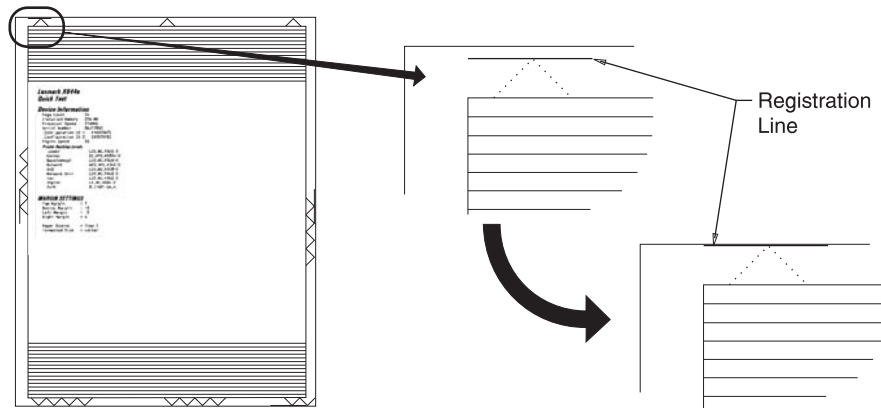

1. Print the Quick Test page.

- a. Touch **REGISTRATION** from the Diagnostics Menu.
- b. Touch  to select Quick Test. You may need to scroll to the next page.

Retain this page to determine the changes you need to make to the margins settings. The diamonds in the margins should touch the margins of the page.



2. To change the value of any of the margin settings:

- Touch  to the right of the appropriate margin setting. The panel displays the setting's name in the header and  [setting's current value]  in a menu below the header row.
- Touch  to decrease the value or  to increase the value.
- Touch **Submit** to save the change, or Touch **Back** to cancel and return to the Diagnostics Menu.
- Touch **Submit** to save all changed values.

The device prints a Quick Test page from the appropriate paper tray. While the Quick Test page prints, **Printing Alignment Page** appears on the LCD.

Quick Test page

The Quick Test contains the following information:

- Device information
- Printer margin settings
- Scanner margin settings
- Alignment diamonds at the top, bottom, and each side.
- Horizontal lines for skew adjustment
- General printer information, including current page count, installed memory, processor speed, serial number, Engine ID, and system card ID.

To print the Quick Test page:

Note: Print the Quick Test Page on letter or A4 paper.

1. Touch **REGISTRATION** from the Diagnostics Menu.
2. Touch  to select Quick Test.
The message **Quick Test Printing...** appears on the display.
Once the Quick Test Page completes printing, the Registration screen displays again.
3. Touch **Back** to return to the Diagnostics Menu.

Print Tests

This setting tests the printer's ability to generate printed output from each of its installed input sources and to test the printer's current print quality.

Input sources

The purpose of the diagnostic Print Tests is to verify that the printer can print on media from each of the installed input options. The contents of the Print Test Page varies depending on the media installed in the selected input source.

Check each Test Page from each source to assist in print quality and paper feed problems.

To run the Print Test Page:

1. Select **PRINT TESTS** from the Diagnostics menu.
2. Select the media source to test:
 - Tray 1
 - Tray 2 (if installed)
 - MP Feeder
 - Envelope Feeder/MP Feeder
3. Select **Single** or **Continuous**.
 - If **Single** is selected, a single page is printed.
 - If **Continuous** is selected, printing continues until **Stop** is pressed to cancel the test.
 - If a source is selected that contains envelopes, an envelope test pattern is printed. If Continuous is selected, the test pattern is printed only on the first envelope.

Note: The Print Test Page always prints on one side of the paper, regardless of the duplex setting or the presence of a duplex option.

Touch **Back** to return to PRINT TESTS.

Print Quality Pages (Prt Quality Pgs)

The purpose of this diagnostic function is to allow printing of the print quality test pages with the toner cartridge lockout function disabled. The print quality pages consist of four pages. Page one contains a mixture of graphics and text. Page two is gray with two one-inch black squares located on the bottom right. Page three is a solid black page, and page four is blank. If duplex is turned on, the pages are duplexed. The Print Quality Test pages are printed in English and must always be printed on letter, legal, or A4 paper.

To run the Print Quality Test Pages, touch  beside Printing Quality Test Pages from PRINT TESTS. The message **Printing Quality Test Pages** is displayed.

Note: The print quality test pages can also be printed from the Configuration menu (CONFIG MENU), however, a cartridge must be installed with a machine class ID matching the machine class ID stored in NVRAM. Additional diagnostic information may be printed on the pages when printing from DIAGNOSTICS.

The following is included in the DIAGNOSTICS version of the print quality pages:

- Values from EP SETUP in DIAGNOSTICS, including:
 - Fuser temperature, warm-up time, transfer, print contrast, charge roll settings and gap adjust.
- Contents of the EVENT LOG from DIAGNOSTICS.
- Configuration information, including printer serial number, controller code level, engine code level, operator panel code level, font versions, and cartridge information.
- Default values for the QUALITY MENU settings used to print the pages.

Hardware Tests

Select the following Hardware Tests from this menu:

- Panel Test
- Button Test
- DRAM Test
- USB HS Test Mode

Panel Test

This test automatically toggles each pixel of the touchscreen through every contrast level beginning with the darkest and on to the brightest. This test continues until you press **Stop** .

Button Test

The Button Test verifies the operation of the buttons on the operator panel. When you select Button Test, a diagram of the operator panel appears on the panel. When you press a button on the operator panel, the corresponding touchscreen key is emphasized. Touch **Back** to cancel the test.

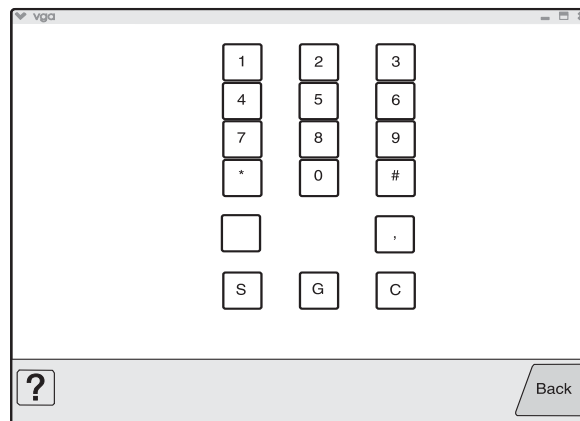

DRAM Test

The purpose of this test is to check the validity of DRAM memory, both standard and optional. The test writes patterns of data to DRAM to verify that each bit in memory can be set and read correctly.

To run the DRAM Test:

1. Touch  to select DRAM Test from the menu.
The message **DRAM Test Testing...** displays. Then the message **Resetting Printer** appears, and the power indicator light *blinks* red.
2. Turn the printer off and on. While the DRAM test executes, the power indicator *blinks* green.
The following type of message appears:

```
DRAM Test <###      P:#####      F:####
```

- xxx represents the installed DRAM size.
- P:##### represents the number of times the memory test has passed and finished successfully. Initially 000000 displays with the maximum pass count being 999,999.
- F:#### represents the number of times the memory test has failed and finished with errors. Initially 0000 displays with the maximum fail count being 99,999. Initially only four digits appear, but additional digits appear as needed.

Each time a test is completed, the number of pass and failures increments. If the test fails, the message **Failure** displays for approximately three seconds, and the failure count increases by one.

The test continues until all standard and optional DRAM is tested. Once the maximum pass count or fail count is reached, the test is stopped, the power indicator is turned on solid, and the final results display.

To stop the test before completion, turn the MFP off.

Serial 1 Wrap

This test is used to the serial port option card.. It only appears if the card is installed in the PCI slot.

To run the SERIAL 1 WRAP Test:

1. Touch  to select **Serial 1 Wrap** from HARDWARE TESTS.
The message **Serial 1 Wrap Test Testing...** displays. Then the message **Resetting Printer** appears.
2. The printer automatically performs a Power On Reset (POR). While the CACHE test executes, the power indicator *blinks* green.
The following type of message appears:
3. To stop this test before completion, turn the MFP off.

USB HS Test Mode

1. Select **USB HS Test Mode** from HARDWARE TESTS.
2. Press ▼ until the ✓ appears next to the Port to be tested, and then press .
3. Select the desired Test, and then press .

Port	Test	Appears on the display
Port 0	Test J Test K Test SEO NAK Test Packet Test Force Enabled	USB High Speed Certification Testing...
Port 1	Test J Test K Test SEO NAK Test Packet Test Force Enabled	USB High Speed Certification Testing...
Port 2	Test J Test K Test SEO NAK Test Packet Test Force Enabled	USB High Speed Certification Testing...
Port 3	Test J Test K Test SEO NAK Test Packet Test Force Enabled	USB High Speed Certification Testing...

To stop testing before completion, turn the printer off.

Duplex Tests



Quick Test (duplex)

This test prints a duplex version of the Quick Test that can be used to verify that the correct placement of the top margin on the back side of a duplex page. You can run one duplexed page (**Single**), or continue printing duplexed pages (**Continuous**) until **Stop**  is pressed. For information about changing the margin, see **“Top Margin (duplex)” on page 3-25**.

Note: Before you set the duplex top margin, be sure to set the registration. See **“Registration (printer)” on page 3-18**.

The paper you choose to print the page on should be either Letter or A4.

To run the Quick Test (duplex):

1. Touch  to select **Quick Test** from DUPLEX TESTS.
2. Touch  to select **Single** or **Continuous**.
 - The single Duplex Quick test cannot be canceled.
 - The printer attempts to print the Quick Test Page from the default paper source. If the default paper source only supports envelopes, then the page is printed from Tray 1.
 - Check the Quick Test Page for the correct offset between the placement of the first scan line on the front and back side of a duplexed sheet.

The single test stops automatically when a single duplex sheet is printed, and the continuous test continues until you press **Stop** .

Top Margin (duplex)

This setting controls the offset between the first scan line on the front of the duplex page and the first scan line on the back of the page. Therefore, be sure to set the top margin in REGISTRATION before setting the duplex top margin. See **“Registration (printer)” on page 3-18**.

To set the Top Margin (duplex):

1. Print the Quick Test (duplex):
 - a. Touch  to select **Quick Test** from DUPLEX TESTS.
 - b. Select **Single**.
 - c. Hold the page to the light to see the whether the top margin of the backside aligns with the top margin of the front side.
2. Select **Top Margin** from DUPLEX TESTS.
3. Use the arrows to increase or decrease the current setting displayed on the touchscreen to select the margin setting:
 - ◀ [setting's current value] ▶.
 - Each increment shifts the duplex top margin by 1/100 of an inch.
 - The Top Margin (duplex) range is -25 to +25, and the default value is 0.
 - An increase moves the top margin down and widens the top margin. A decrease moves the top margin upward and narrows the top margin.
4. Touch **Submit**.
5. Print the Quick Test (duplex) again to verify the adjustment. Repeat if necessary.

Sensor Test (duplex)

This test is used to determine whether or not the duplex sensors and switches are working correctly. The test allows you to actuate the duplex input sensor located in the back part of the duplex unit and the duplex exit sensor located in the return paper path.

1. Select **Sensor Test** from DUPLEX TESTS.
The message **Sensor Test Testing** displays.
2. Manually actuate each of the duplex sensors. When the sensor/switch is closed, **CL** (closed) displays, and when the sensor/switch is open, **OP** (open) displays.
 - Duplex input sensor
 - Duplex exit sensor
3. Press **Stop**  to exit the test.

Motor Test (duplex)

This test lets you test the duplex option paper feed drive system, and verify that the power and velocity values are acceptable. The duplex runs the DC motor at high speed and low speed, taking an average of the power (PWM) required for each speed and calculating the KE value.

To run the Motor Test (duplex):

1. Select **Motor Test** from DUPLEX TESTS.
The power indicator light *blinks*, and the message **Motor Test Testing** displays.
2. When the motor stops, the results are displayed. Listed below is an example of such results:



```
Duplex Motor Test Test Passed
Avg. PWM of High-Speed Test: 1d
Avg. PWM of Low-Speed Test: 0e
Max. PWM of Low-Speed Test: 00
Min. PWM of Low-Speed Test: 0b
Motor KE Value: 2d
Motor Test Results: 00
```

3. Touch **Back** or press **Stop**  to exit the test.

Duplex Feed 1

This test feeds a blank sheet of paper to the duplex paper stop position 1. This test can be run using any of the supported paper sizes.



To run the Duplex Feed 1 Test:

1. Touch  to select **Duplex Feed 1** from DUPLEX TESTS.
The power indicator blinks while the paper is feeding, and the message **Duplex Feed 1 Feeding...** displays.
The message **Duplex Feed 1 Clear Paper** displays when the paper reaches paper stop position 1, and the power indicator turns on solid.
2. Remove the media from the duplex unit, and clear the message on the operator panel by pressing **Stop** .

Duplex Feed 2

This test feeds a blank sheet of paper to the duplex paper stop position 2. This test can be run using any of the supported paper sizes.

To run the Duplex Feed 2 Test:





1. Touch  to select **Duplex Feed 2** from DUPLEX TESTS.
The power indicator blinks while the paper is feeding, and the message **Duplex Feed 2 Feeding...** displays.
The message **Duplex Feed 2 Clear Paper** displays when the paper reaches the duplex paper stop position 2, and the power indicator turns on solid.
2. Remove the media from the duplex unit, and clear the message on the operator panel by touching **Back** or pressing **Stop** .

Input Tray Tests

Feed Tests (input tray)



This test lets the servicer observe the paper path as media is feeding through the printer. A blank sheet of paper feeds through the printer as the laser turns off during this test. The only way to observe the paper path is to open the lower front door that is used to access the envelope or multipurpose feeder. The paper is placed in the output bin.

To run the Input Tray Feed Tests:

1. Touch  to select **Feed Tests** from INPUT TRAY TESTS.
2. Touch  to select the input source from the sources displayed on the Feed Tests menu. All installed sources are listed.
3. Touch  to select either Single or Continuous.
 - **Single**—feeds one sheet of media from the selected source.
 - **Continuous**—media continues feeding from the selected source until **Stop**  is pressed.

Sensor Test (input tray)

This test is used to determine if the input tray sensors are working correctly. To run the Input Tray Sensor Test:

1. Touch  to select the **Sensor Test** from INPUT TRAY TESTS.
2. Touch  to select the input source from the sources displayed on the Sensor Test menu. All installed sources are listed.

- Select the sensor to test. Various sources have different combinations of sensors. See the table below:

Tray sensor support by source

Source	Empty (Input tray empty sensor)	Low (Input tray paper low sensor)	passThru (Input tray pass thru sensor)
Tray 1	X	X	
Tray 2	X	X	X
Multipurpose tray	X		
Envelope feeder	X		

[*sensor selected*]=Open displays.





- Empty—Input tray empty sensor
 - Low—Input tray paper low sensor
 - passThru—Input tray pass thru sensor
- Once this message displays, the servicer can manually actuate each sensor. The tray empty sensor can be actuated by hand, however a sheet of paper can be used to cover the pass thru sensor. When the sensor is closed, **CLosed** displays; when the sensor is open, **Open** displays.
 - Press **Stop**  to exit the test.

Output bin tests

Feed Tests (output bins)

Use these tests to verify that media can be fed to the standard output bin. No information is printed on the media fed to the output bin, because the printhead is not engaged during this test. These tests can use any media size or envelope supported by the printer.

To run the Feed Tests for the output bins:



- Touch  to select **Feed Tests** from the OUTPUT BIN TESTS.
- Touch  to select the output bin you want the paper to exit into.
- Touch  to select either Single or Continuous.
 - **Single**—feeds one sheet of media from the selected source.
 - **Continuous**—media continues feeding from the selected source until **Stop**  is pressed.

Touch **Back** to return to OUTPUT BIN TESTS.

Sensor Test (standard output bin)

This test is used to verify if the standard bin sensor is working correctly.

To run the Sensor Test for the standard bin:

- Touch  to select **Sensor Test** from OUTPUT BIN TESTS.
- Touch  to select **Standard Bin** from Sensor Tests.
- Manually actuate the bin sensor by moving the flag in and out of the sensor, and the display changes. The following screen is displayed:
Bin Empty: empty or **Bin Empty: full**.
- Press **Stop**  to exit the test.

Base Sensor Test

This test is used to determine if the sensors located inside the printer are working correctly.

To run the Base Sensor Test:



1. Select **BASE SENSOR TEST** from the DIAGNOSTICS menu.
The following sensors are listed:
 - Toner Level—Toner level sensor (remove the cartridge and replace to actuate the sensor)
 - Input—Input sensor
 - Output—Output (exit) sensor
 - NarrowMedia—Output (exit) sensor
 - Front Door—Front door sensor
2. Manually actuate the sensors to verify that each sensor switches from **Open** to **Closed**.
3. Press **Stop**  to exit the test.

DEVICE TESTS

Quick Disk Test

This test performs a non-destructive read/write on one block per track on the disk. The test reads one block on each track, saves the data, and proceeds to write and read four test patterns to the bytes in the block. If the block is good, the saved data is written back to the disk.

To run the Quick Disk Test:

1. Touch  to select **Quick Disk Test** from DEVICE TESTS.
The power indicator blinks while the test is in progress, and **quick Disk Test Testing...** displays.
 - **Quick Disk Test/Test Passed** message displays if the test passes, and the power indicator turns on solid.
 - **Quick Disk Test/Test Failed** message displays if the test failed, and the power indicator turns on solid.
2. Press **Stop**  to return to the Device Tests menu.

Disk Test/Clean

Warning: This test destroys all data on the disk and should not be attempted on a good disk. Also note that this test may run approximately 1½ hours depending on the disk size.

To run the Disk Test/Clean Test:

1. Touch  to select **Disk Test/Clean** from the Device Tests menu.
Contents will be lost. Continue? message displays to warn the user that all contents on the disk will be lost.
2. Touch **Yes** to continue and **No** to exit.
If **Yes** is selected, the following screen displays and updates periodically, indicating the percentage of test completed.

```

Formatting Disk
1/1           0%
  
DO NOT POWER OFF
  
```

The power indicator blinks during the test.

Note: The test can NOT be canceled.

- Once the test is complete, the power indicator turns on solid, and either the message **Disk Test/Clean Test Passed** or **Disk Test/Clean Failed** appears. If the message indicates failure, the disk is unusable.

PRINTER SETUP

PRINTER SETUP			
Defaults	◀	US	▶ ▲
Printed Page Count		127	
Permanent Page Count		127	
Serial Number		xxxxxxx	▶
Engine Setting 1	◀	0	▶
Engine Setting 2	◀	0	▶ ▼
<input type="button" value="Submit"/>		<input type="button" value="Back"/> <input type="button" value=""/>	

The triangles pointing up or down indicate whether there are additional menus. Touch the up or down arrows to display these additional menus.

Note: If you make changes, touch **Submit** to make the change effective.

Defaults

US/Non-US defaults changes whether the printer uses the US factory defaults or the non-US factory defaults. The settings affected include paper size, envelope size, PCL symbol set, code pages, and units of measure.

Warning: Changing this setting resets the printer to factory defaults, and data may be lost. It cannot be undone.

Printed Page Count

The page count can only be viewed and cannot be changed.

Touch **Back** to return to Diagnostics Menu.

Permanent Page Count

The permanent page count can only be viewed and cannot be changed.

Touch **Back** to return to Diagnostics Menu.

Serial Number

The serial number can only be viewed and cannot be changed.

Touch **Back** to return to Diagnostics Menu.

Engine Settings 1 through 4

Do not change these settings unless requested to do so by your next level of support.

Model Name

The model name can only be viewed and cannot be changed.



Configuration ID

The two configuration IDs are used to communicate information about certain areas of the printer that cannot be determined using hardware sensors. The configuration IDs are originally set at the factory when the printer is manufactured, however, the servicer may need to reset Configuration ID 1 or Configuration ID 2 whenever you replace the system board. The IDs consist of eight hexadecimal characters, including 0 through 9 and A through F.

Note: When the printer detects a Configuration ID that is not defined or invalid, the following occurs:

- The default standard model Configuration ID is used instead.
- Configuration ID is the only function available in DIAGNOSTICS.
- Unless the menu is in DIAGNOSTICS, **Check Config ID** displays.

To set the configuration ID:

1. Touch  to select **PRINTER SETUP** from the Diagnostics Menu.
2. Touch  to select **Configuration ID**.
3. Touch the keyboard icon to display a keyboard with 1 through 0 and a through f. The current values for Configuration ID 1 and Configuration ID 2 are displayed.
 - Use keys to type the numbers for the two configuration IDs.
 - Use the left arrow to move over a digit from the right of the number toward the left.
 - When the numbers are correct, touch **Submit**.
 - If you have a question, touch the question mark icon.
 - To exit without changing the numbers, touch **Back**.

Note: Be sure to touch **Submit**, or the number will not be changed.

Submitting Selection displays, followed by the value for Configuration ID 1.

Note: If **Invalid ID** appears, the entry is discarded, and the previous Configuration ID 1 is displayed on the screen.

If the process is successful, **Submitting Selection** appears on the display, followed by the current value for Configuration ID 2.

4. Restart the printer.

Edge to Edge

When this setting is On, the text and graphics are shifted to the physical edges of the paper for all margins. When the setting is Off, the normal margins are restored.

Enable Edge to Edge Copy

The settings are ON and OFF.

EP SETUP

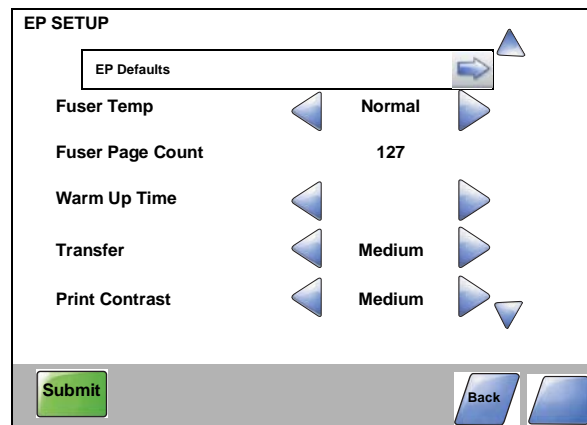



The triangles pointing up or down indicate whether there are additional menus. Touch the up or down arrows to display these additional menus.

Note: If you make changes, touch **Submit** to make the change effective.

EP Defaults

This setting is used to restore each printer setting listed in EP SETUP to its factory default value. Sometimes this is used to help correct print quality problems.

To restore EP Defaults:

1. Touch  to select **EP Defaults** from EP SETUP.
2. Touch  to select **Restore** to reset the values to the factory settings, and touch  to select **Do Not Restore** to exit without changing the settings.

Touch **Back** to exit without changing the settings.

Fuser Temperature (Fuser Temp)

This adjustment can be used to help solve some customer problems with paper curl on low-grade papers and problems with letterheads on some types of media.

The fuser temperature can be adjusted to: Normal, Lower, Lowest. The default is Normal.

Touch **Back** to return to Diagnostics Menu.

Fuser Page Count

The fuser page count can only be viewed and cannot be changed.

Touch **Back** to return to Diagnostics Menu.

Warm Up Time

You can change the amount of time the printer warms up before allowing pages to print by changing this setting from 0 to 5. The factory sets the warm up at 0 or no warm up time. This time period lets the backup roll heat up and helps reduce curl in some environments.

Touch **Back** to return to Diagnostics Menu.

Transfer

The transfer can be adjusted to Low, Medium, or High. The default setting is Medium.

Touch **Back** to return to Diagnostics Menu.

Print Contrast

The print contrast setting controls the developer voltage offset.

The print contrast can be adjusted to Low, Medium, or High. The default setting is Medium.

Touch **Back** to return to Diagnostics Menu.

Charge Roll

The charge roll can be adjusted to Low, Medium, or High. The default setting is Medium.

Touch **Back** to return to Diagnostics Menu.

Gap Adjust

The setting adjusts the minimum gap between sheets. Increasing this value may reduce curl of some printed media and eliminate some output bin stacking problems. However, increasing this value also results in slower overall performance, measured in pages per minute. The range of values is 0 to 255, and the default value is 0.

Touch **Back** to return to Diagnostics Menu.

Auto Dark Adjust

The settings are Enable and Disable.

Reports

Menu Settings Page



This enables you to print the Menu Settings Page. The report prints the Diag Menu to include Registration, Print Tests, Hardware Tests, Duplex Tests, Input Tray Tests, Output Bin Tests, Device Tests, Printer Setup, EP Setup, Reports, Event Log, Development Menu, and Scanner Tests.

EVENT LOG

Display Log

The event log provides a history of printer errors. It contains the 12 most recent errors that have occurred on the printer. The most recent error displays in position 1, and the oldest error displays in position 12 (if 12 errors have occurred). If an error occurs after the log is full, the oldest error is discarded. Identical errors in consecutive positions in the log are entered, so there may be repetitions. All 2xx and 9xx error messages are stored in the event log.

To view the event log:

1. Touch  to select **Display Log** from EVENT LOG.
Up to three error codes display at a time. Touch  to display additional information, if available.
2. Touch **Back** to return to the EVENT LOG menu.

Print Log

Additional diagnostic information is available when you print the event log from Diagnostics Menu rather than Configuration Menu.

The Event Log printed from Diagnostics Menu includes:

- Detailed printer information, including code versions
- Time and date stamps
- Page counts for most errors
- Additional debug information in some cases

Event Log (Page 1)

Lexmark X644e (s/n:xxxxxxxx)

Device Information

Page Count 42
 Installed Memory 256 MB
 Processor Speed 512MHz
 Engine ID 5D
 Engine LC_MC_0004-0
 Loader L10_MC_F0A8-0
 Kevnet L10_MC_A020A-0
 Base L10_MC_F0A8-0
 AIO L10_MC_F0A8-0
 Fax M10_MC_F0A8-0
 Network M10_MC_F0A8-0
 Panel v1.2.1
 Font 8.17661.01.4
 Scanner 0000.0033

Event Log Information

JFFS2 Partition Format

Event Message JFFS2 partition format: Security files, 26274 Bytes

000.00 Service RIP Software

Page Count 2
 Error Count 3 Sun Sep 19 10:25:13 2005 UTC
 Date and Time 3 Mon Sep 19 03:45:16 2005 UTC
 Job Name

Code Levels

01	0101-0000-0000	Wed Sep 7 09:19:08 2005	min	0.0
1	Loader L10_MC_F0A8-0	Wed Sep 7 10:07:30 2005	min	0.0
2	Kevnet L10_MC_A020A-0	Wed Sep 7 10:00:04 2005	min	0.0
3	Base L10_MC_F0A8-0	Wed Sep 7 10:00:37 2005	min	0.0
4	Network M10_MC_F0A8-0	Wed Sep 7 09:51:00 2005	min	0.0
5	RIP L10_MC_F0A8-0	Wed Sep 7 10:00:11 2005	min	0.0
6	Network F10_MC_A020A-0	Wed Sep 7 09:50:10 2005	min	0.0
10	L10-0000-0000	Wed Sep 7 10:01:05 2005	min	0.0
14	L10-L10_MC_F0A8-0	Wed Sep 7 10:00:30 2005	min	0.0
16	Page L10_MC_F0A8-0	Wed Sep 7 10:01:12 2005	min	0.0
20	Spooler L10_MC_F0A8-0	Wed Sep 7 09:59:12 2005	min	0.0
21	IO Data 1.0	Wed Sep 7 10:01:05 2005	min	0.0
22	L10 Data 1.0	Wed Sep 7 10:01:05 2005	min	0.0
23	Security Files 1.0	Wed Sep 7 10:01:05 2005	min	0.0
24	BootManagerData 1.0	Wed Sep 7 10:01:05 2005	min	0.0
25	IO Data 1.0	Wed Sep 7 10:01:05 2005	min	0.0
27	Spooler 1.0	Wed Sep 7 10:01:05 2005	min	0.0
28	Page Data 1.0	Wed Sep 7 10:01:05 2005	min	0.0
29	Engine M10_MC_A020A-0	Wed Sep 7 09:58:04 2005	min	0.0
30	Workshop 1.0	Wed Sep 7 10:01:05 2005	min	0.0
31	Network M10_MC_F0A8-0	Wed Sep 7 09:51:17 2005	min	0.0

Scanner Job

Event Message 000.00 Scanner job, remove all originals

Page Count 2
 Error Count 3 Sun Sep 19 10:24:43 2005 UTC
 Date and Time 3 Mon Sep 19 03:45:16 2005 UTC
 Job Name

The printed event log can be faxed to Lexmark or your next level of support for verification or diagnosis.

To print the event log:

Touch to select **Print Log** from EVENT LOG.

Clear Log

Use Clear Log to remove the current information in the Event Log. This affects both the viewed log and the printed log information.

1. Touch to select **Clear Log** from the Event Log menu.
2. Touch to select **Yes** to clear the Event Log, or touch to select **NO** to exit the Clear Log menu. If **YES** is selected, **Deleting EVENT LOG** displays on the screen.

Scanner Tests



ASIC Test

A pattern appears and **ASIC Test Passed** displays. If xxxxxx displays, the test was unsuccessful.

Press **Stop**  to return to the SCANNER TESTS menu.

Feed Test

To run the Scanner Feed test:

1. Touch  to select Feed Test from the SCANNER TESTS menu.
2. The panel displays the setting's current value  [setting's current value] . Use the arrows to select from Letter, Legal, or A4.
3. Touch **START** to begin.
Running Flatbed... displays.
Press **4** to exit the test.
4. Touch **Back** to return to the Diagnostics Menu.

Sensor Tests

The following tests are available:

- P - Sensor (ADF Paper Present)
- A - Sensor (ADF cover closed interlock)
- F - Sensor (FB scanner cover interlock)
- 1 - Sensor (ADF sensor 1)
- 2 - Sensor (ADF sensor 2)
- H - Sensor (FB Home position)

1. Touch  to select Sensor Test from the SCANNER TESTS menu.
2. The display will show P, F, H, A, 1, 2 in a vertical column.

Note: Every scanner sensor does not need to be tested when Scanner Tests is selected.

3. To test the paper present sensor, push back on the actuator (A). If the sensor is functioning, the 0 next to the P on the display will change to 1.

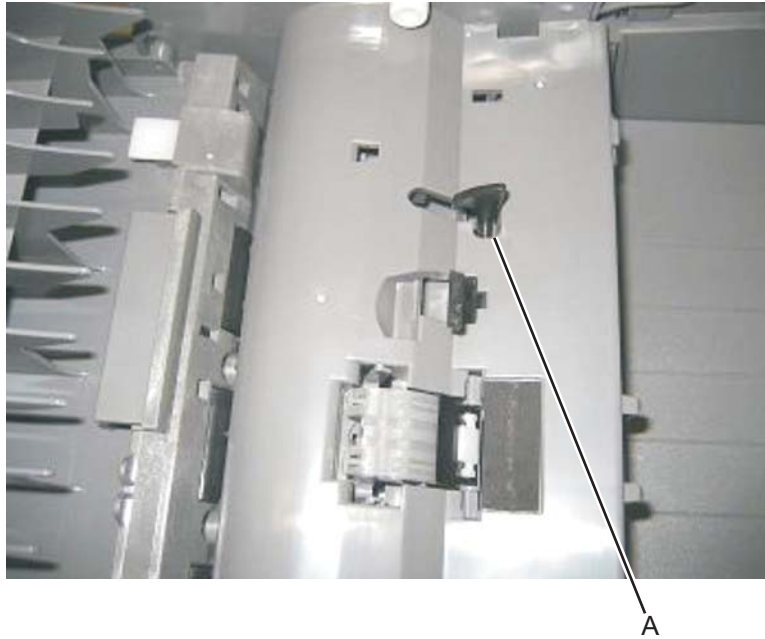

4. To test the flatbed cover closed sensor, lift the flatbed cover. The 0 next to the F will change to 1. Also check the actuator (B) to ensure it is functioning properly.

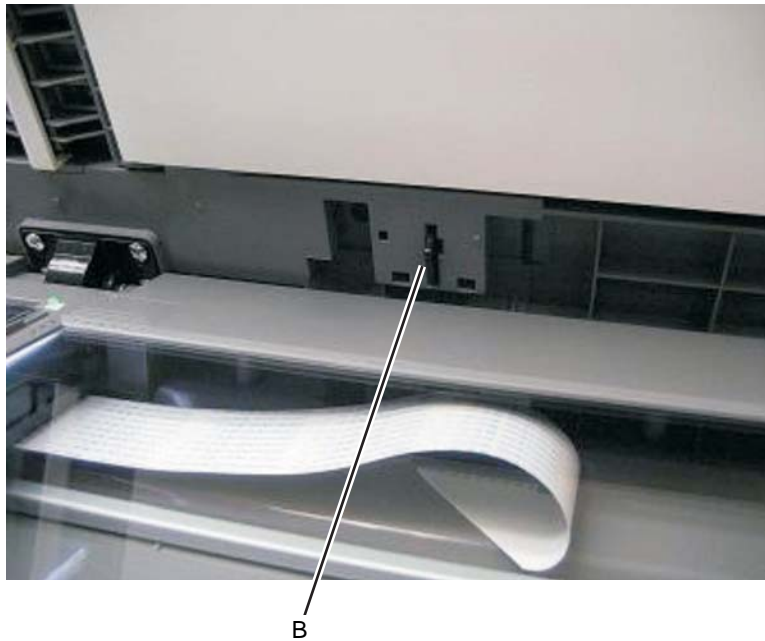

5. To test scanner sensor 1 press on the tab (C). The 0 next to the 1 will change to 1 if the sensor is working properly.



6. To test scanner sensor 2 press on the tab (D). The 0 next to the 2 will change to 1 if the sensor is working properly.
7. To test the ADF cover open sensor, open the ADF top cover. If the sensor is functioning properly the 0 next to the A will change to 1.

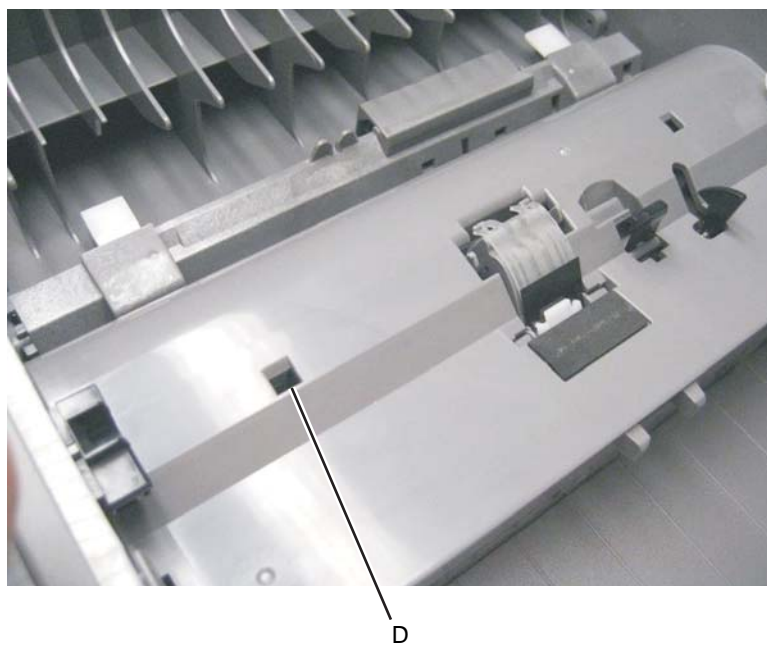

8. Press **Stop**  to return to the SCANNER TESTS menu.

Exit Diagnostics

Selecting **EXIT DIAGNOSTICS** exits the Diagnostics menu, and Resetting the Printer displays. The printer performs a POR, and the printer returns to normal mode.

Printhead assembly electronic adjustment

Note: Before aligning the printhead electronically, first align the printhead mechanically, if needed. See **“Printhead assembly mechanical adjustment” on page 3-39.**

1. Enter the Diagnostics menu. See **“Entering Diagnostics menu” on page 3-17.**
2. Touch **Registration** to enter the Registration menu.
3. Touch **Quick test** to print the Quick test page.

Quick Test page (sample only; use actual sheet)

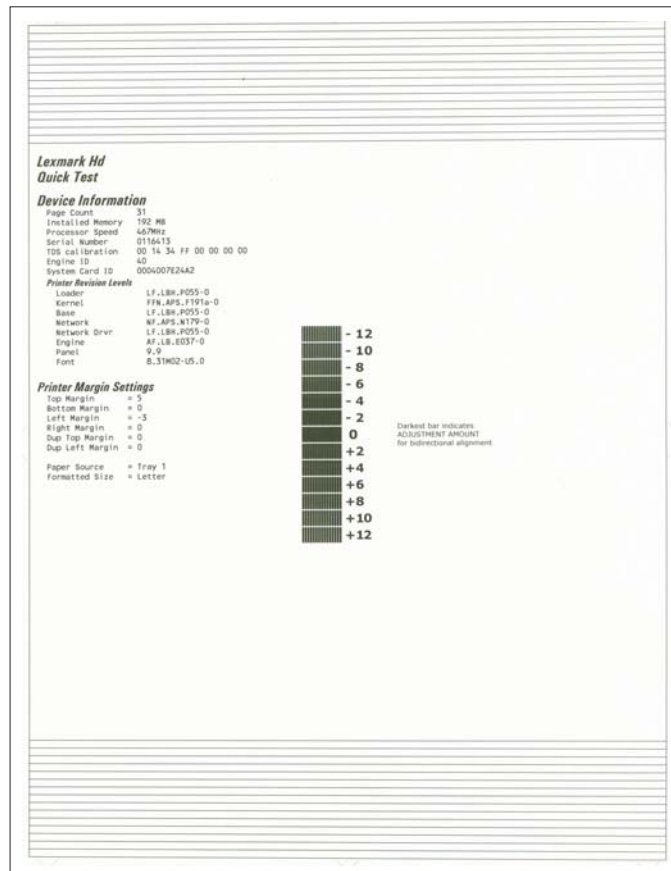

4. In the Registration menu, select the right margin setting.
5. To determine the margin setting, choose the value that is closest to the darkest bar on the center graph of the margin page. Add that value to the current right margin setting printed on the left hand side of the margin page. (The right margin setting will also appear on the operator panel display.) For example, if the right margin setting on the page is -2, and the number that is closest to the darkest line on the graph is 3 (-2+3), then the right margin setting will be equal to +1.
6. Press or to the desired setting, and press .

- Print the Quick Test page again and check that the darkest line in the center graph is equal to zero. If it is, then check to see if the left, top, and bottom margins are detected. If it is not, then repeat step 5.

Note: The alignment of the left margin positions the black plane to the right or left. The alignment of the right margin does not alter the margins and should only be used to adjust the printhead.

Printhead assembly mechanical adjustment

A printhead needs to be correctly positioned after it has been removed. Use a pencil to mark the screw locations of the old printhead on the metal frame. Align the new printhead relative to the location of the old printhead.

Note: Skew is caused by a sheet being fed through the printer while misaligned. The entire image is rotated relative to the sheet edges. However, a mechanically misaligned printhead causes the horizontal lines to appear skewed, while the vertical lines remain parallel to the vertical edges. There are no adjustments for skew. Check the pick roll (paper pick assembly) for wear, the paper path for obstructions, the fuser for proper setting, and the tray paper guides for fit to the media.

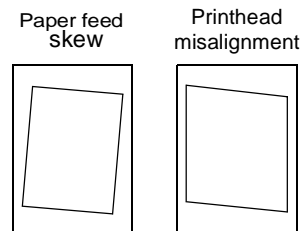

To adjust the printhead:

- Enter the Diagnostics Menu. See **“Entering Diagnostics menu” on page 3-17**.
- Select PRINT TESTS.
- Select Tray 1.
- Select Single.
- Fold the printed test page on the left side so that a few millimeters of grid lines wrap around the outside of the fold. See photo below.
- Fold a second vertical fold near the center so that the left side top edge aligns with the right side top edge.



7. If the grid lines of the right flap align below the corresponding lines on the left flap, then adjust the printhead clockwise relative to the printer, and recheck. (See the left side of the figure below.) If the grid lines of the left flap align below the corresponding lines of the right side, then adjust the printhead counterclockwise. (See the right side of the figure below.)

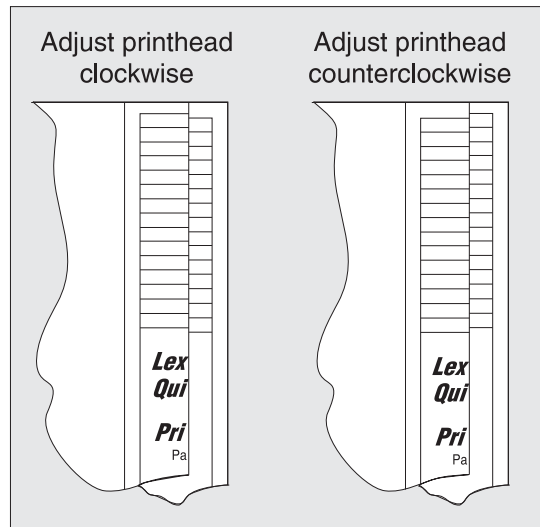

8. After obtaining a properly adjusted image on the paper, tighten all three screws.

Note: The printhead **must** be aligned electronically. See **“Printhead assembly electronic adjustment”** on **page 3-38**.

SE Menu

Note: This is not the Fax SE menu. To enter the Fax SE menu, press **411 from the Ready screen.

Note: This menu should be used as directed by second-level support.

Print SE Menus

General

Copyright - Displays copyright information.

Optra Forms mode - On or off

Code Revision Info

Network Code Level - Displays network code level

Network Compile Info - Displays compile information

Printer Code Level - Displays printer code information

Printer Compile Info - Displays compile information

History

Print History

Mark History

History Mode

MAC

Set Card Speed

LAA

Keep Alive

NVRAM

Dump NVRAM

Re-init NVRAM

NPAP

Print Alerts

TCP/IP

netstat -r

arp -a

Allow SNMP Set

MTU

Meditech Mode

Raw LPR Mode

Gather Debug

Enable Debug

Paper jams

Avoiding jams

Most paper jams can be avoided by correctly loading paper and specialty media in the printer.

The following hints can help prevent paper jams:

- Use only the recommended print media.
- Do not overload the print media sources. Make sure the stack height does not exceed the maximum height indicated by the stack line on the labels in the sources.
- Do not load wrinkled, creased, damp, or curled print media.
- Flex, fan, and straighten print media before loading it. If jams do occur with the print media, then try feeding one sheet at a time through the manual feeder.

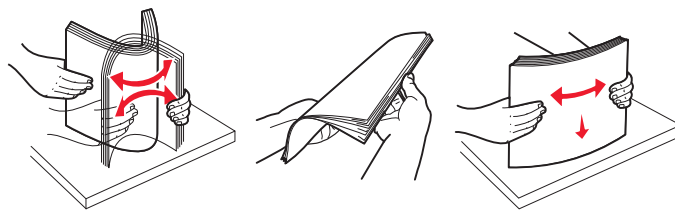

- Do not mix print media sizes, weights, or types in the same print media source.
- Push all trays in firmly after loading them.

Note: Make sure the media stack is below the maximum media fill indicators on the 250-sheet tray before pushing the tray into the printer.

- Make sure paper guides are positioned before loading the paper or specialty media.
- Do not remove trays while a job is printing.
- Before loading transparencies, fan the stack to prevent sheets from sticking together.
- Do not use envelopes that:
 - Have excessive curl
 - Are stuck together
 - Are damaged in any way
 - Contain windows, holes, perforations, cutouts, or embossments
 - Have metal clasps, string ties, or metal folding bars
 - Have postage stamps attached
 - Have any exposed adhesive when the flap is in the sealed position
- Use only recommended media. Refer to the *Card Stock & Label Guide* available on the Lexmark Web site at www.lexmark.com for more information about which media provides optimum results for the current printing environment.

Understanding jam numbers and locations

The following illustration shows the areas of the MFP where jams occur. When paper jams occur, follow the instructions in this section.

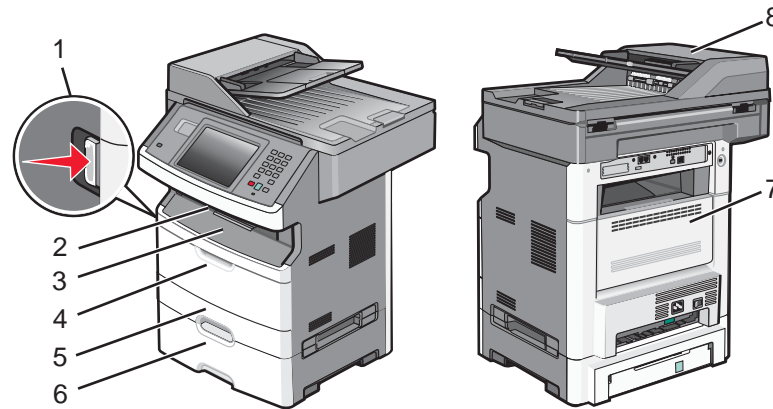

Jam area number	Description
1	Opened front door
2	Paper output bin
3	Front door
4	Multi purpose feeder
5	Tray 1
6	Tray 2
7	Rear door
8	Automatic document feeder (ADF)

Jam messages and their locations

200 and 201 paper jams

CAUTION: Hot surface. The inside of the printer may be hot. To reduce the risk of injury from a hot component, allow the surface to cool before touching it.

1. Pull the tray completely out.

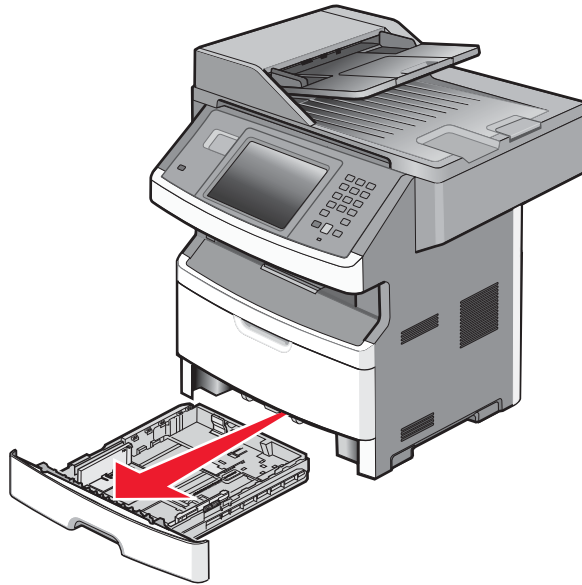

2. Remove the paper jam.

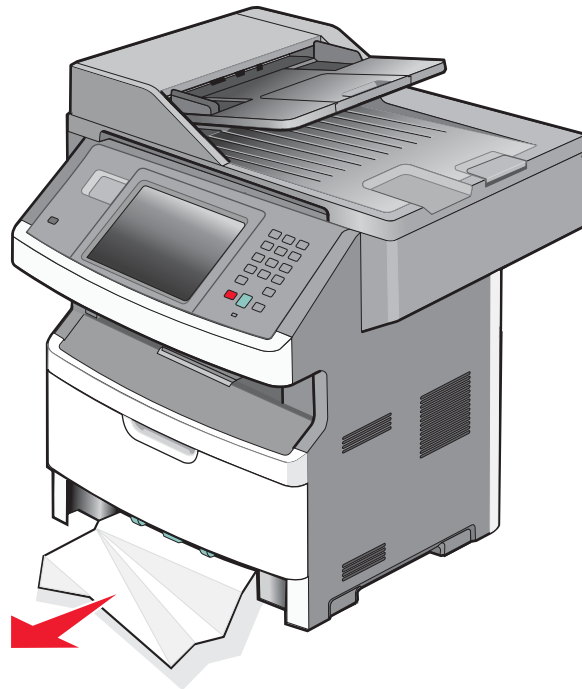

3. If the paper is not visible, open the front door and remove the photoconductor kit and toner cartridge.
4. Remove the jam.

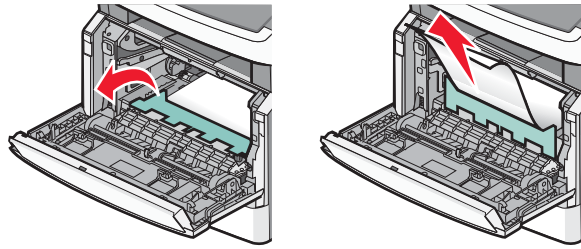

5. If the paper is still not visible, open the rear door.

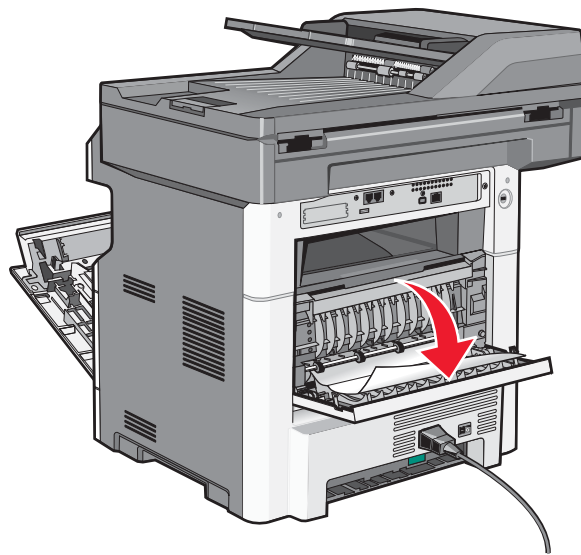

6. Remove the jam.

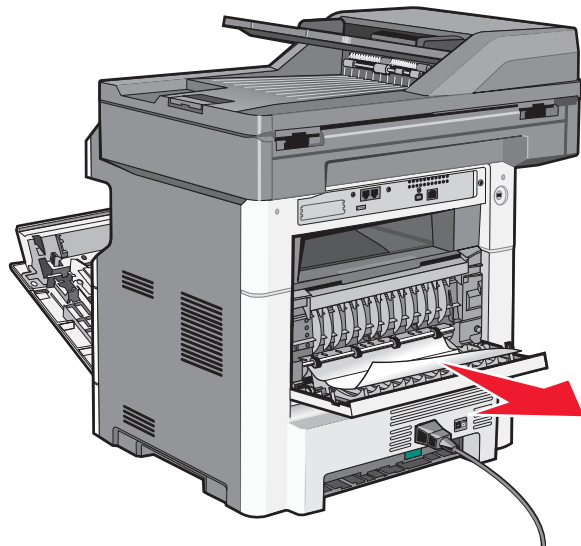

7. Close the rear door.
8. Reinsert the photoconductor kit and toner cartridge.
9. Close the front door.
10. Touch **Continue**.

202 paper jam

Touch **Status/Supplies** to identify the location of the jam. If the paper is exiting the MFP into the exit bin, pull the paper out and touch **Continue**.

If the paper is still in the paper path:

1. Open the rear door.

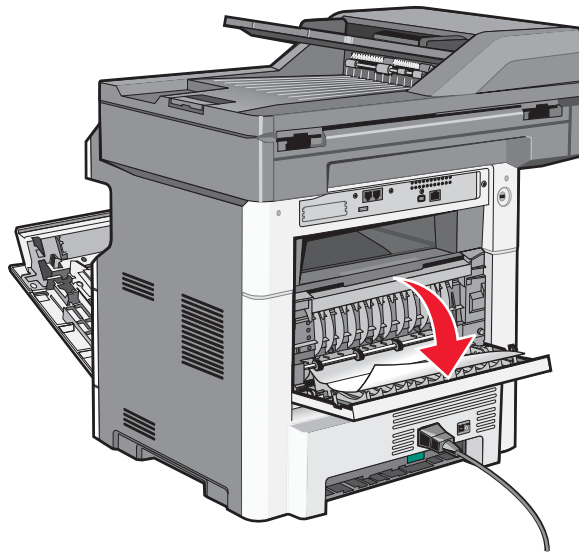

2. Remove the jammed paper.
3. Close the rear door.
4. Touch **Continue**.

231 paper jam

CAUTION: Hot surface. The inside of the printer may be hot. To reduce the risk of injury from a hot component, allow the surface to cool before touching it.

1. Open the front door.
2. Open the rear door.

3. Remove the jam.

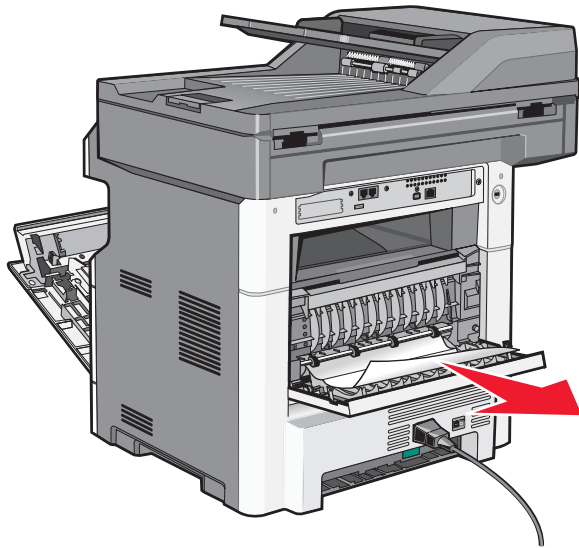
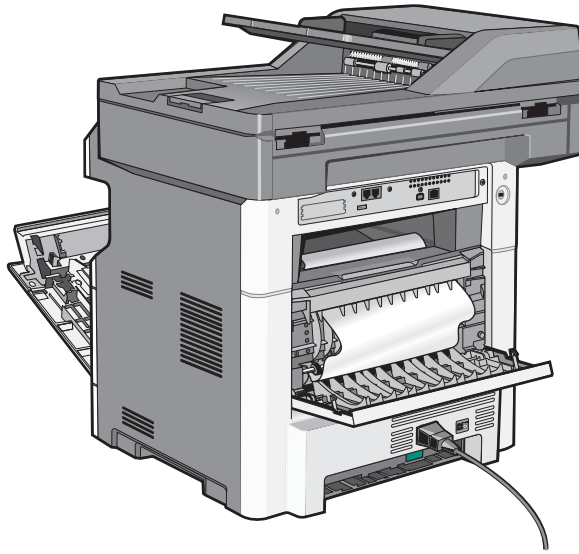

4. Close the rear door.
5. Close the front door.
6. Touch **Continue**.

233 paper jam

1. Remove the tray from the printer.

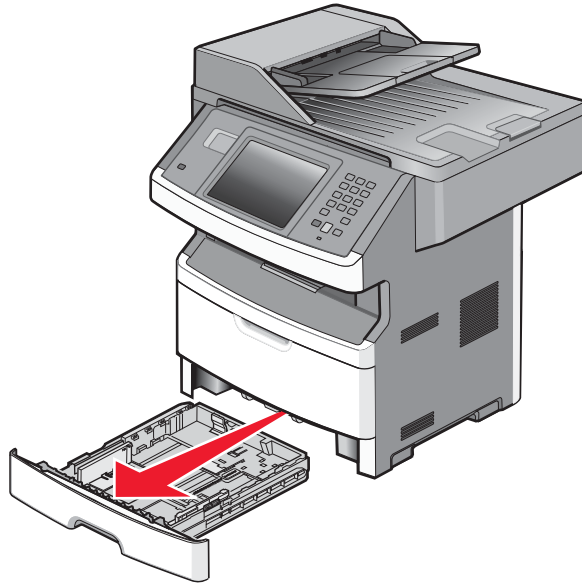

2. Locate the duplex release lever and pull it down to release the paper.

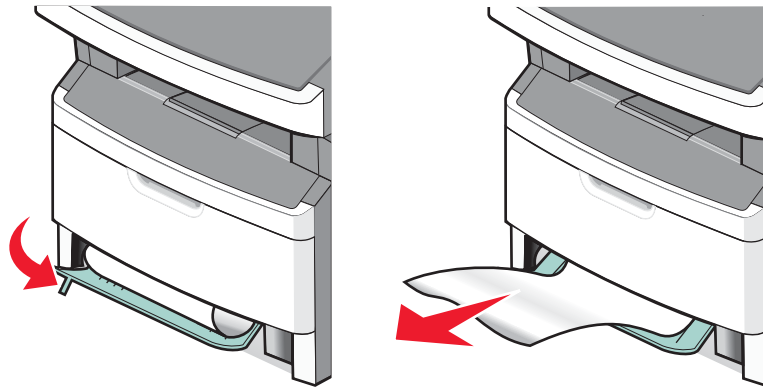

3. Insert the tray.
4. Touch **Continue**.

If this does not clear the jam, perform the steps found in 231 paper jam. See **“231 paper jam” on page 3-46.**

234 paper jam

This jam error indicates single or multiple jams in the duplex area of the MFP. Perform the steps in the following jam removal procedures:

231 paper jam. See **“231 paper jam” on page 3-46.**

233 paper jam. See **“233 paper jam” on page 3-48.**

235 paper jam

1. Gently pull the jammed media from the fuser.

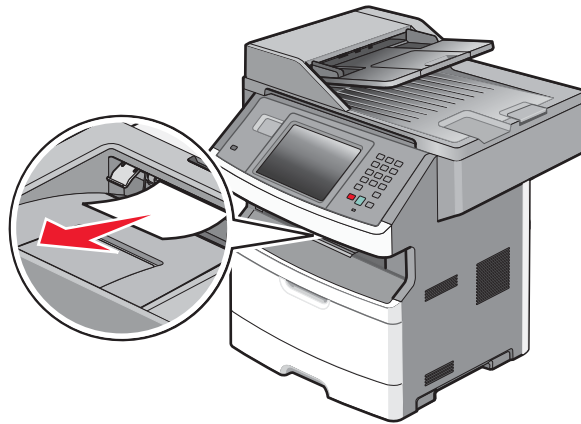

2. Touch **Continue**.

240 - 249 paper jams

1. Touch **Supplie/Status** to identify the jam location.
2. Remove the standard tray.
3. Remove any jammed paper.

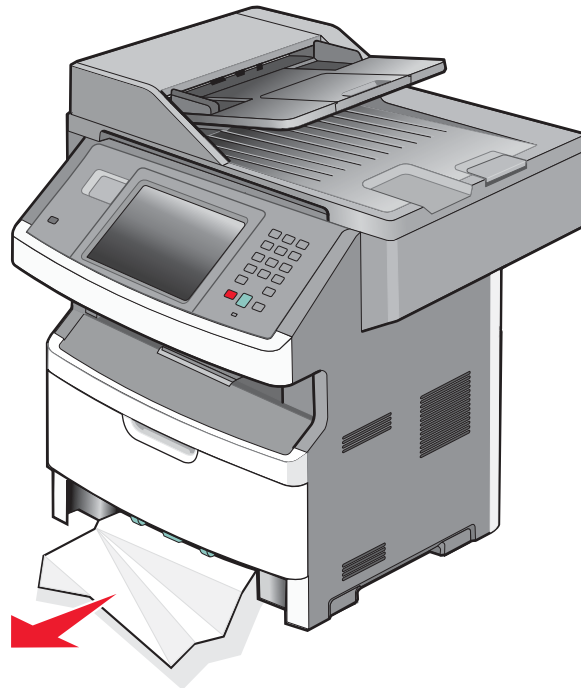

4. Reinsert the tray, and touch **Continue**.
5. If the jam message remains, remove the optional tray.

6. Remove any jammed paper.
7. Reinsert the option tray, and touch **Continue**.

250 paper jam

1. Touch **Supplies/Status** to find the jam location.
2. Remove the media from the multipurpose feeder.
3. Remove the jammed media from the multipurpose feeder.

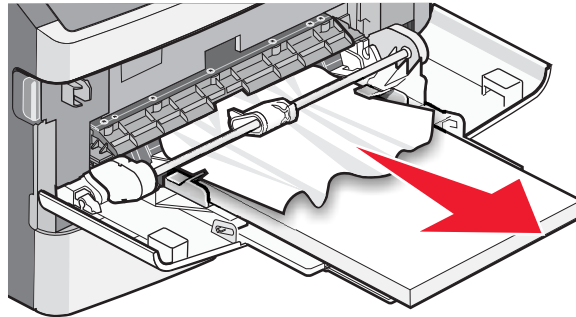

4. Flex and fan the media.
5. Reload the media into the multipurpose feeder.
6. Adjust the guides if needed.

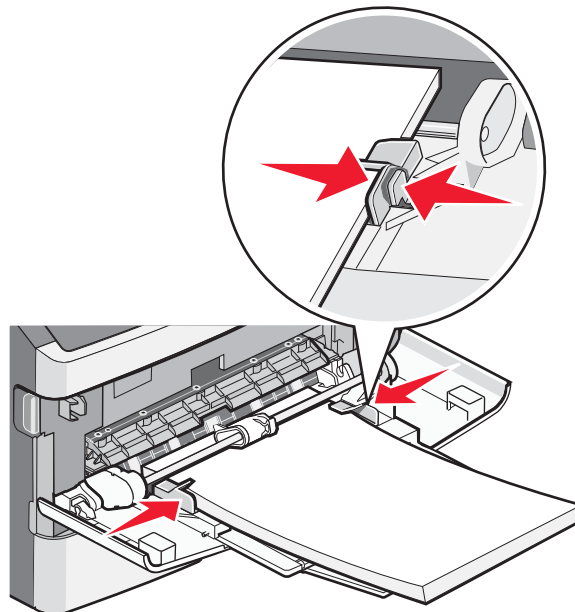

7. Touch **Continue**.

251 paper jam

If the media is visible from the front of the MFP, gently pull the media out of the multipurpose feeder.

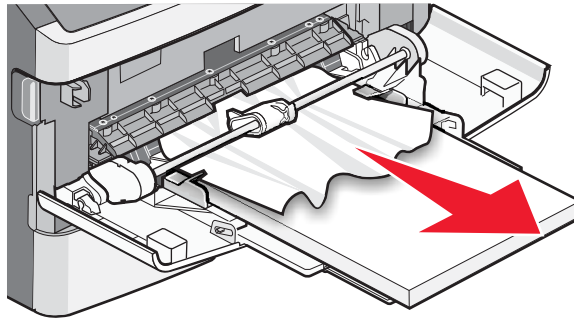

If the media is not visible, perform the following steps to clear the jam:

1. Open the front door, and remove the photoconductor kit and toner cartridge.

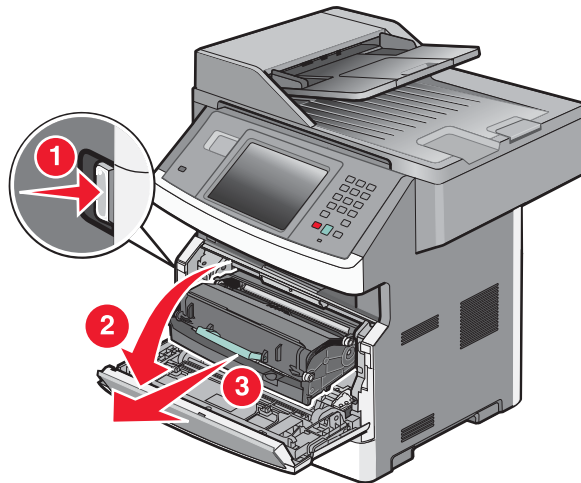

2. Lift the flap at the front of the MFP, and remove any jams.

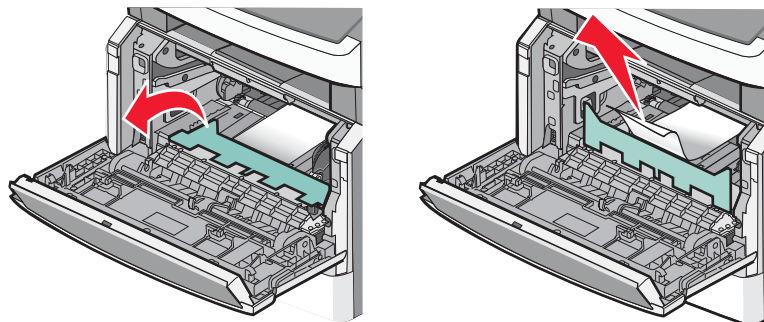

3. Reinsert the photoconductor kit and toner cartridge.

4. Close the front door.
5. Touch **Continue**.

290-294 paper jams

Clearing jams under the ADF cover

1. Remove all original documents from the ADF input tray.
2. Open the ADF cover.

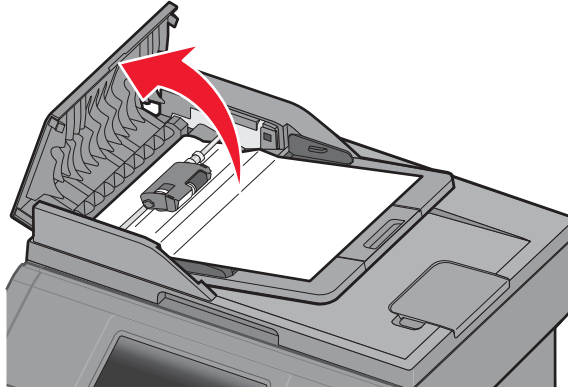

3. Unlock the ADF separator roll.

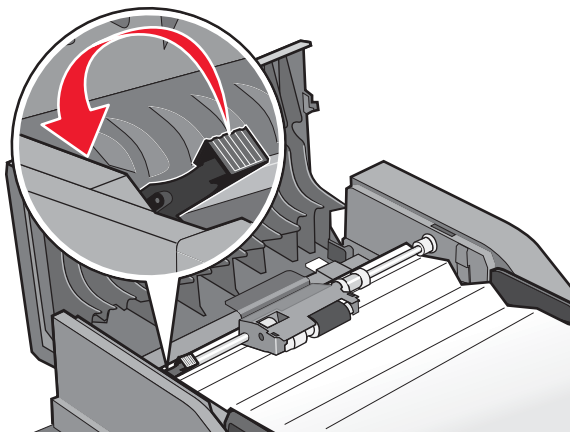

4. Remove the ADF separator roll.

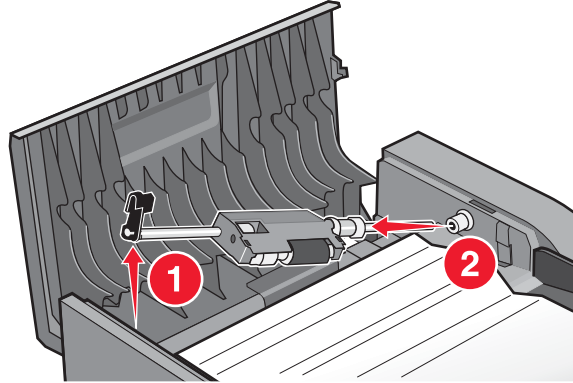

5. Remove the jammed media.

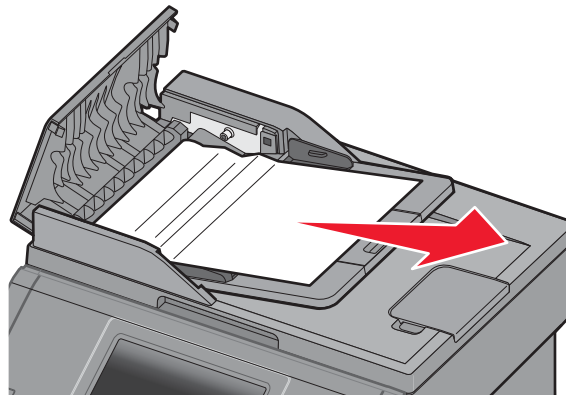

6. Reinstall the ADF separator roll.

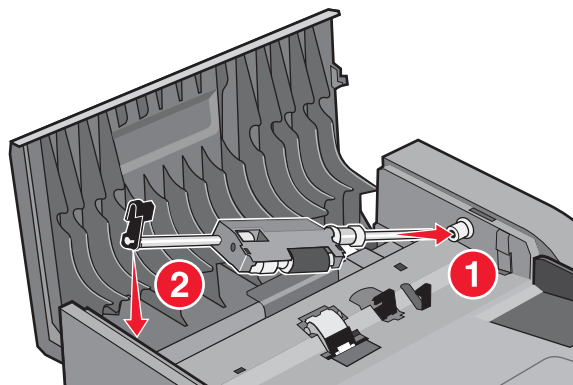

7. Lock the ADF separator roll.

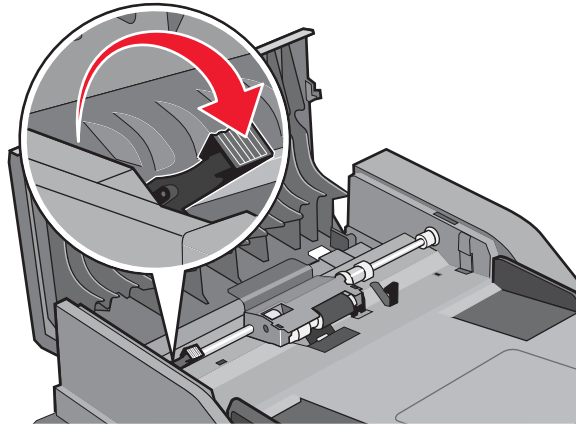

8. Close the ADF top cover.

Clearing ADF jams under the flatbed cover.

1. Lift the flatbed cover, and remove the jammed media from the ADF.

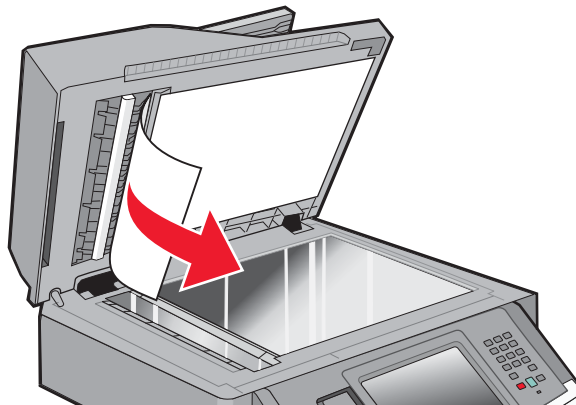

2. Touch **Continue**.

Clearing jams in the duplex ADF

1. Remove the ADF input tray.
2. Pull out the jammed media by pulling on the bottom sheet.

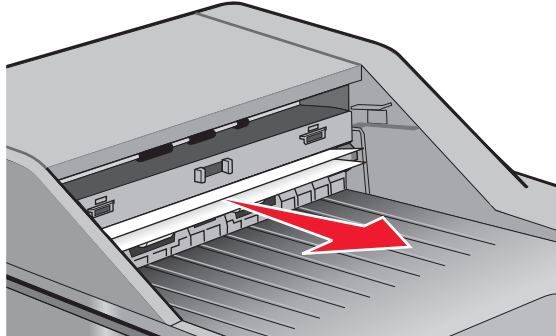

3. Reinstall the ADF input tray.
4. Touch **Continue**.

4. Repair information

Warning: Read the following before handling electronic parts.

Handling ESD-sensitive parts

Many electronic products use parts that are known to be sensitive to electrostatic discharge (ESD). To prevent damage to ESD-sensitive parts, follow the instructions below in addition to all the usual precautions, such as turning off power before removing logic cards:

- Keep the ESD-sensitive part in its original shipping container (a special “ESD bag”) until the part is ready to be installed into the printer.
- Make the least-possible body movements to prevent an increase of static electricity from clothing fibers, carpets, and furniture.
- Put the ESD wrist strap on your wrist. Connect the wrist band to the system ground point. This discharges any static electricity in your body to the printer.
- Hold the ESD-sensitive part by its edge connector shroud (cover); do not touch its pins. If a pluggable module is being removed, then use the correct tool.
- Do not place the ESD-sensitive part on the MFP cover or on a metal table; if the ESD-sensitive part needs to be put down for any reason, then first put it into its special bag.
- Machine covers and metal tables are electrical grounds. They increase the risk of damage, because they make a discharge path from your body through the ESD-sensitive part. (Large metal objects can be discharge paths without being grounded.)
- Prevent ESD-sensitive parts from being accidentally touched by other personnel. Install machine covers when the machine is not being worked on, and do not put unprotected ESD-sensitive parts on a table.
- If possible, keep all ESD-sensitive parts in a grounded metal cabinet (case).
- Be extra careful in working with ESD-sensitive parts when cold-weather heating is used, because low humidity increases static electricity.

Removal procedures

- Remove the toner cartridge and media tray before removing other printer parts. The toner cartridge should be protected from light while out of the printer.
- We recommend disconnecting all external cables from the printer to prevent damage during service.
- Unless otherwise stated, reinstall the parts in reverse order of removal.
- When reinstalling a part held with several screws, start all screws before final tightening.
- Remove the paper tray and print cartridge before proceeding with a removal.



ACM pick tire roller removal

1. Place the printer on its side.
Note: Be careful to not mar the finish of the printer.
2. Open the duplex jam door just far enough to pull out the ACM pick tires.
Warning: Open the duplex door only far enough to remove the ACM pick tires. If the door is opened too far, then it can become disengaged and interfere with the paper tray. The tray may go in but will not come out, and will render the printer non-serviceable.

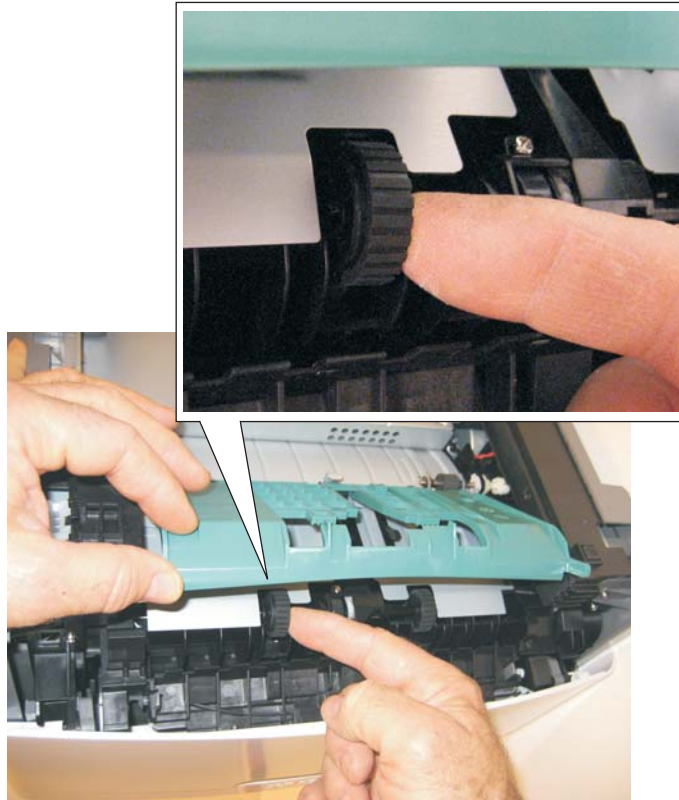

3. After the ACM pick tires have been pulled out, close the duplex door.

4. Remove the ACM pick tire roller (A).
 - If the left hub is gray, then disconnect the old right and left tire/hub assemblies from the ACM, and replace with the new right and left tire/hub assemblies.
 - If the left hub is black, then remove the old right and left tires from the ACM hubs, and replace with the new tires. Do not attempt to remove the hubs.



A

Card reader removal

1. Remove the scanner front cover. See **“Scanner front cover removal”** on page 3-31.
2. Remove the operator panel keypad assembly. See **“Operator panel keypad removal”** on page 4-64
3. Release the tabs on the rear of the operator panel display and tilt it upright.
4. Remove the two screws (A) securing the card reader housing to the tub assembly.

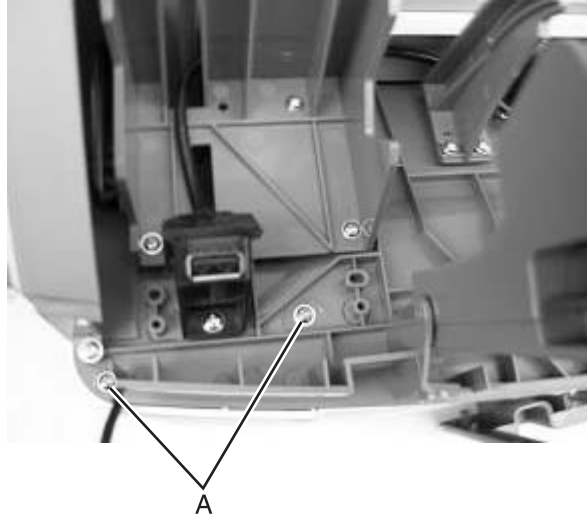

5. Disconnect the card reader cable from the card reader.
6. Remove the LED light tube (B) from the upper card reader cover.

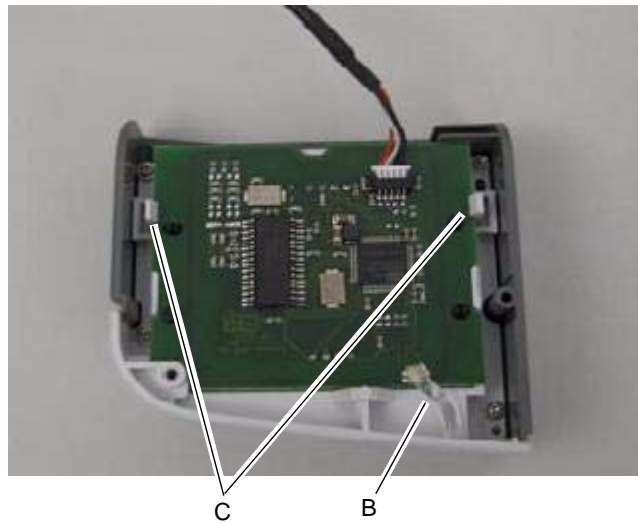

7. Pull the two tabs (C) back and remove the card from the card reader housing.
Note: When replacing the light tube, cover the tube with a small piece of black electrical tape if possible.

Upper and lower card reader cover removal

1. Remove the scanner front cover. See **“Scanner front cover removal” on page 3-31.**
2. Remove the card reader. See **“Card reader removal” on page 4-5.**
3. Remove the four screws (A) fastening the upper and lower card reader covers.

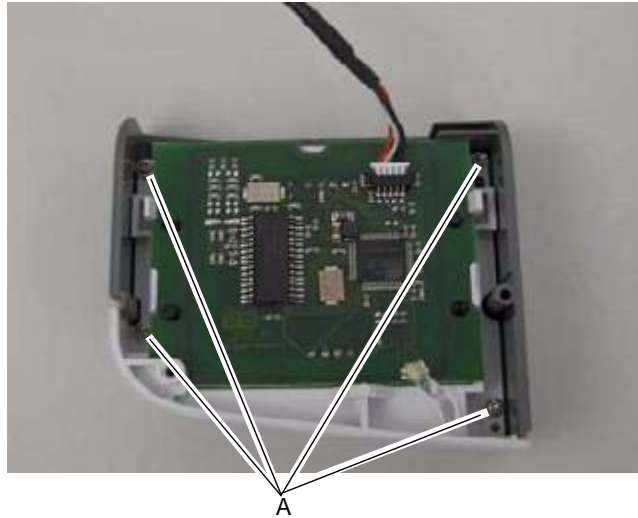

Card reader cable removal

1. Remove the scanner front cover. See **“Scanner front cover removal”** on page 3-31.
2. Remove the operator panel keypad assembly. See **“Operator panel keypad removal”** on page 4-64
3. Release the tabs on the rear of the operator panel display and tilt it upright.
4. Disconnect the card reader cable (A) from the J2 USB port on the controller board.



5. Remove the two screws (B) securing the card reader housing to the tub assembly.

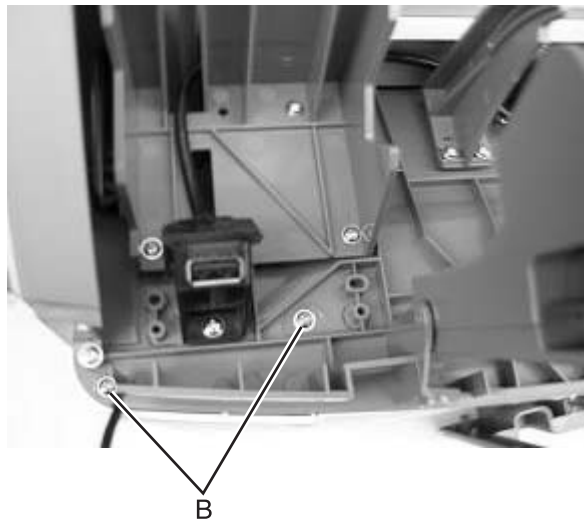

6. Disconnect the cable from the card reader card.

Controller board removal

	<p>CAUTION</p> <p>This product contains a lithium battery. THERE IS A RISK OF EXPLOSION IF THE BATTERY IS REPLACED BY AN INCORRECT TYPE. Discard used batteries according to the battery manufacturer's instructions and local regulations.</p>
---	--

Warning:

- Always touch a ground before touching the board.
 - Handle the board carefully by the edges.
 - Never replace the operator panel and controller board without a successful POR in between.
 - Never replace the operator panel and the controller board at the same time. Each card contains the printer settings. When either of these cards is new, it obtains its settings from the other card. Critical factory settings are lost when both cards are new and are replaced at the same time.
1. Remove the screw (A) from the USB port.



2. Lift the scanner assembly to the raised position.
3. Remove any option cards from the controller board.

4. Using a flatblade screwdriver, depress the kickstand release tab (B).

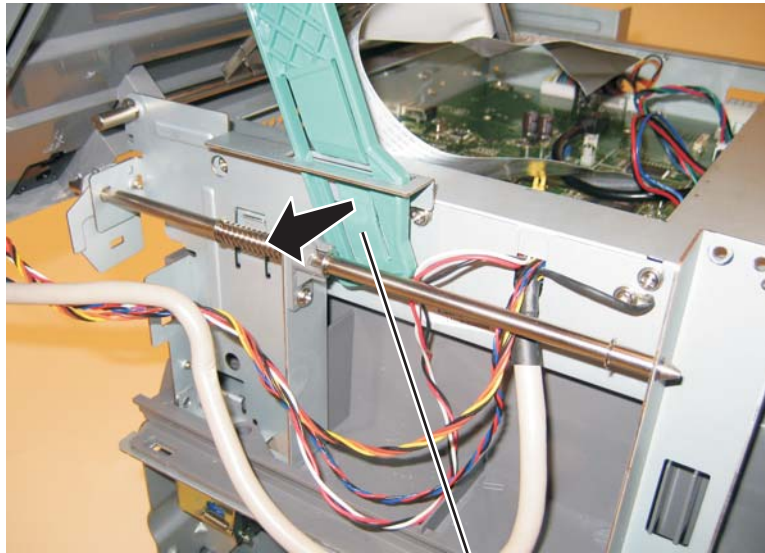

B

5. While depressing the tab, lift the scanner assembly until it is fully vertical.
6. Carefully tilt the ADF down as shown.

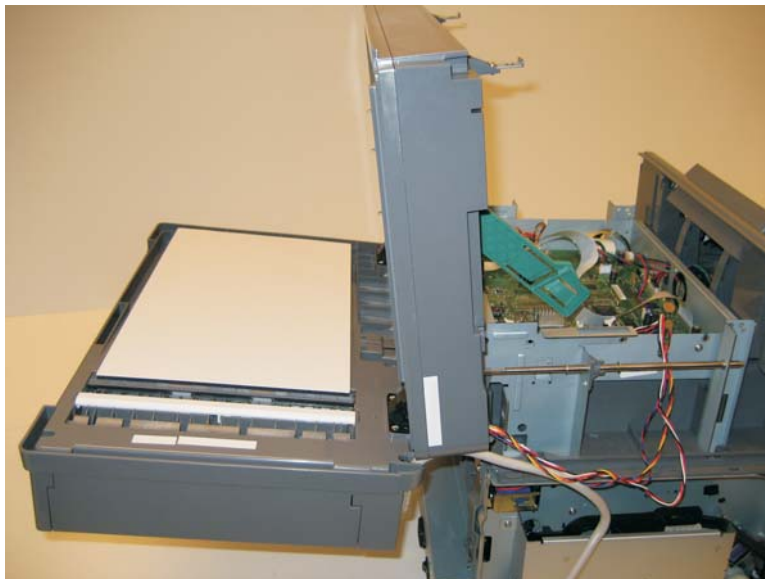

Warning: To avoid damage to the rear frame assemblies, hold the ADF while raising the flatbed to the upright position, then lower the ADF, slowly as shown above.

7. Remove the controller board shield. See **“Controller board shield” on page 4-11.**
8. Disconnect all the cables from the controller board.
9. Tilt the operator panel display to the up position.
10. Route the UICC cable, the front USB cable, and the display panel cables through the hole in the front of the controller board cage.

11. Remove the seven screws (C) securing the controller board to the controller board cage.

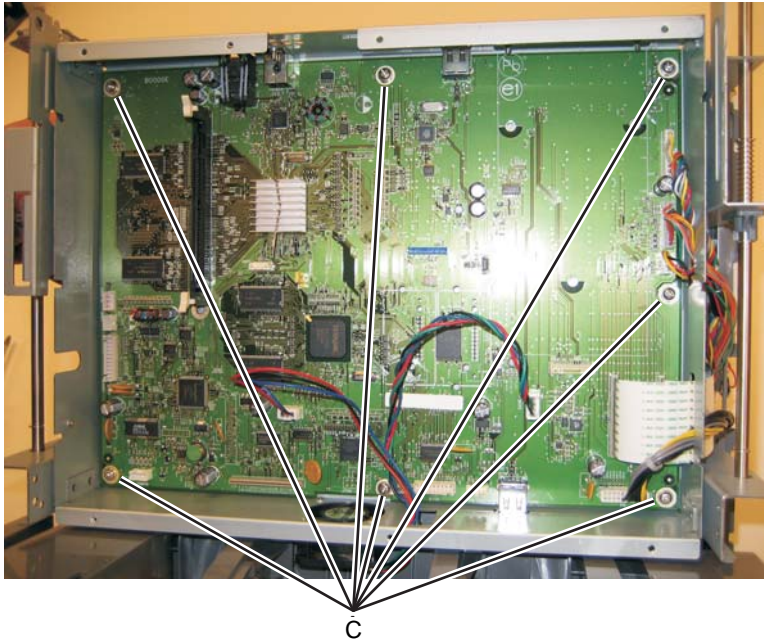

12. Lift the controller board, and remove.
Note: When installing the controller board, place the USB port screw first, and then place the controller board screws.

Controller board shield

1. Remove the two screws (A) securing the controller shield bracket to the controller board cage.



2. Remove the three screws (B) securing the top of the controller shield.



3. Loosen the three screws (C) on each side of the controller board cage.

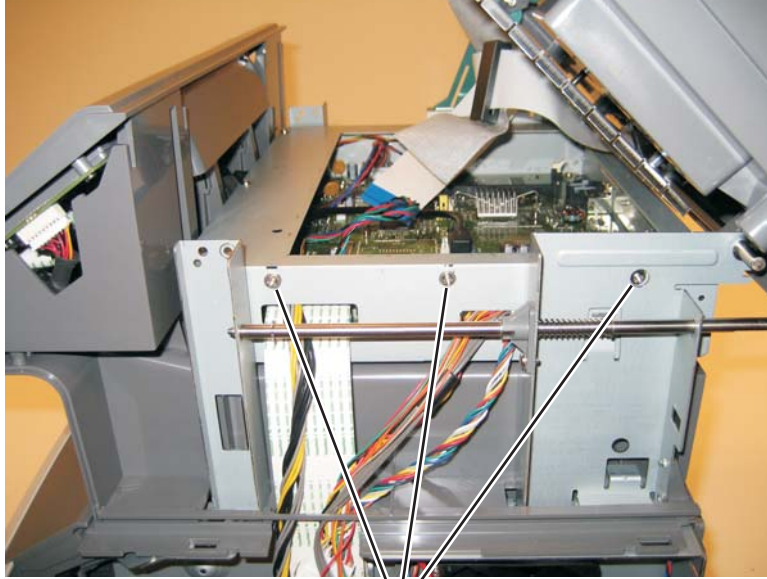

C

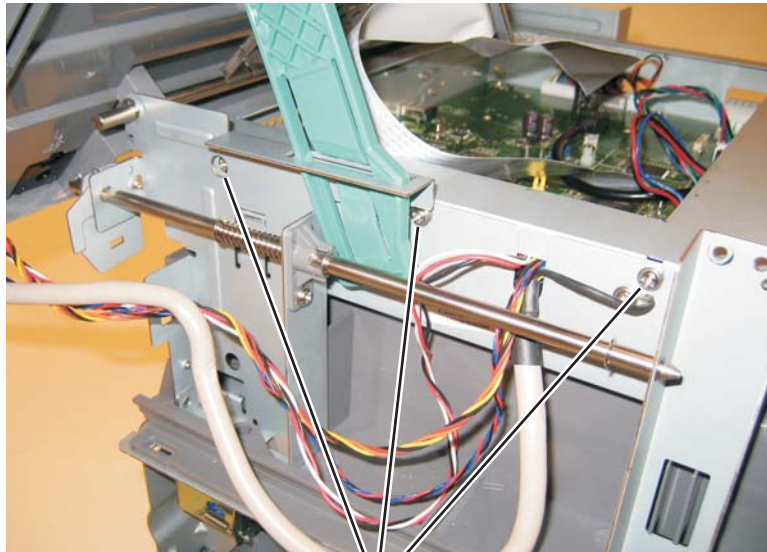

C

4. Remove the controller board shield.

Controller board cage

1. Remove the controller board. See Go to **“Controller board removal” on page 4-8.**
2. Remove the five screws (A) which secure the controller board cage to the tub assembly.

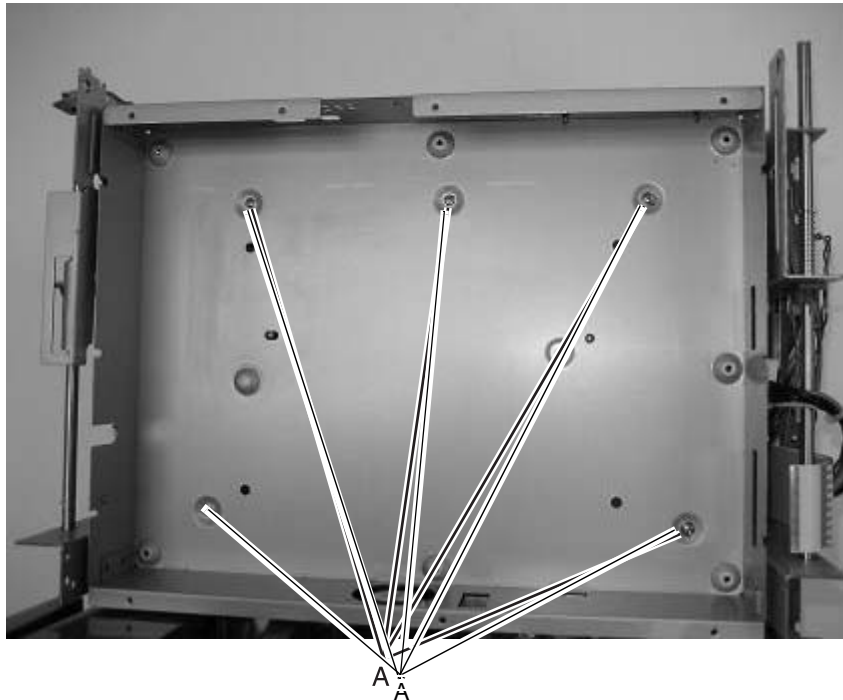

3. Tilt the front of the cage up and remove it from the MFP.

Controller board fan

1. Remove the operator panel display. See Go to **“Operator panel display removal” on page 4-65.**
2. Disconnect the controller board fan cable from J99 on the controller board.
3. Remove the two screws (A) which secure the controller board fan to the controller board cage.

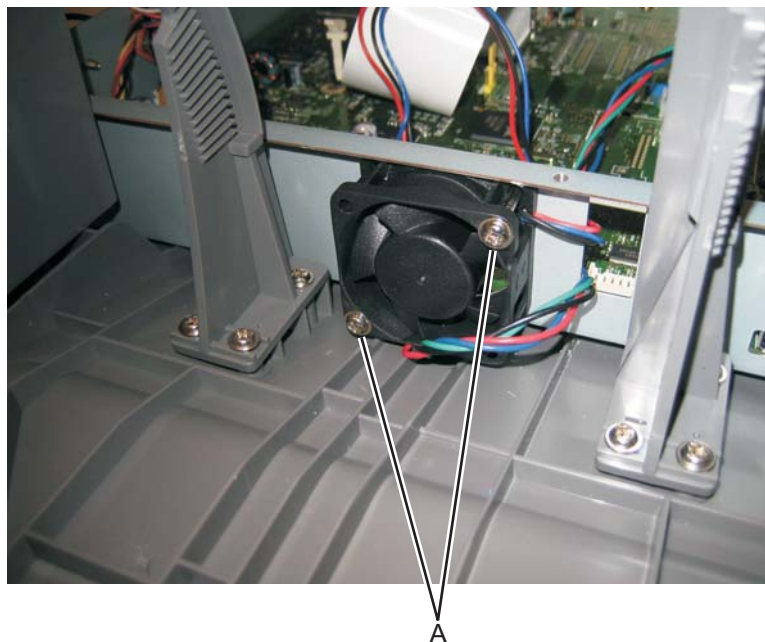

Engine board removal



CAUTION

This product contains a lithium battery. THERE IS A RISK OF EXPLOSION IF THE BATTERY IS REPLACED BY AN INCORRECT TYPE. Discard used batteries according to the battery manufacturer's instructions and local regulations.

1. Remove the right side cover. See Go to **“Right side cover removal” on page 4-80.**
2. Disconnect all the cables from the engine board.
3. Remove the three screws (A securing the engine board to the print engine frame).

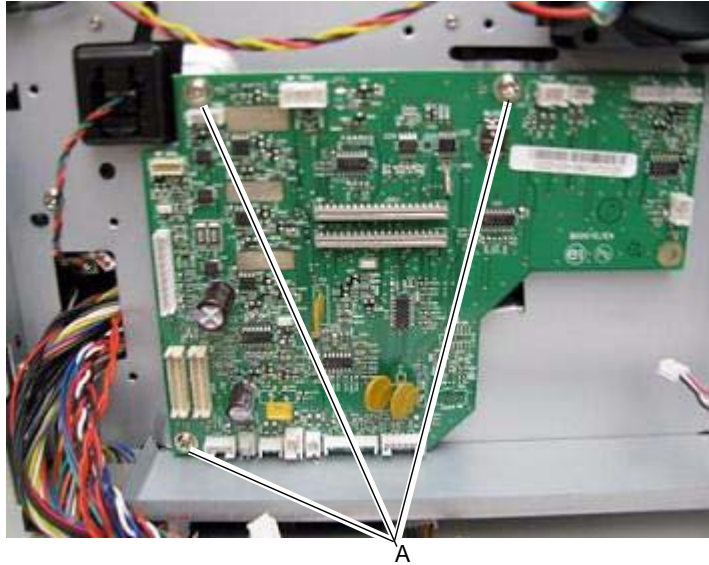

4. Remove the engine board.

Cover open sensor

1. Remove the right side cover. Go to **“Right side cover removal” on page 4-80.**
2. Disconnect the cable from connector J11 on the controller board.
3. Use a #1 Phillips screwdriver to remove the screw (A) holding the sensor.



A

4. Remove the cover open sensor.

Door mount removal

1. Open the front cover.
2. Remove the lower front cover. See **“Lower front cover removal” on page 4-35.**
3. Remove the left side cover. See **“Left side cover removal” on page 4-33.**
4. Remove the right side cover. See **“Right side cover removal” on page 4-80.**
5. Remove the cable through the opening.
6. Remove the three screws (A) from the right side of the printer.

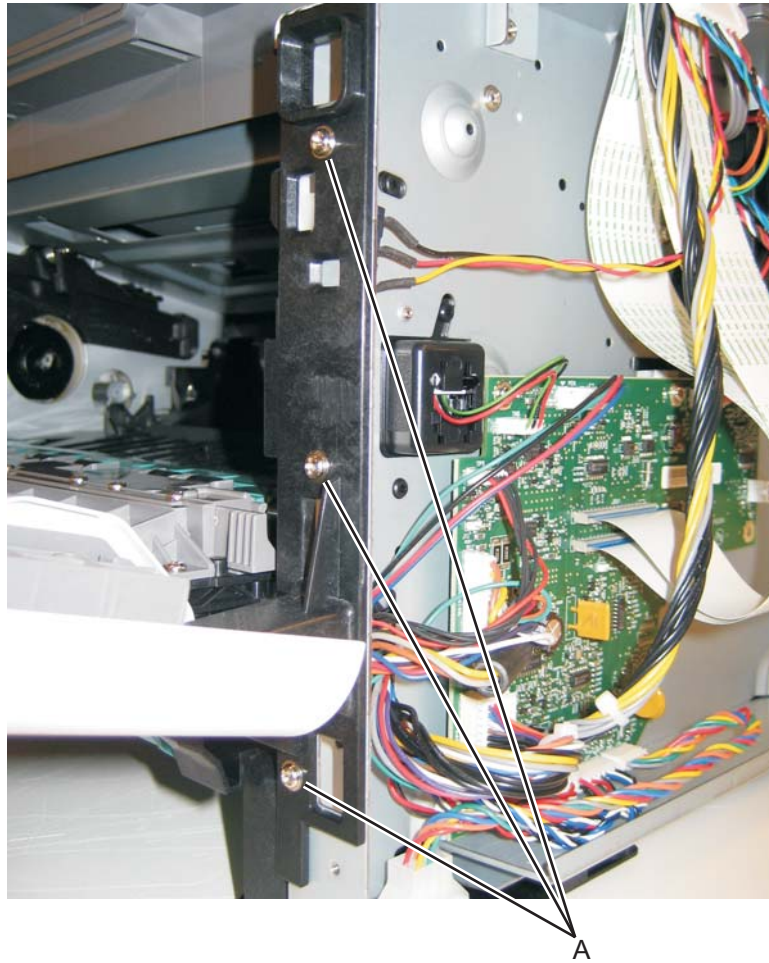

7. Disconnect the fuser link (B).

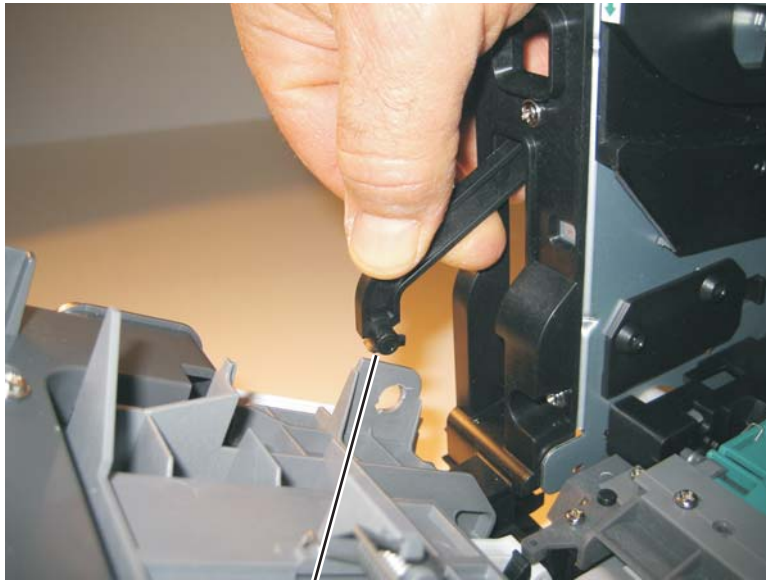

B

8. Remove the three screws (C) from the left side of the printer.



C

9. Remove the door mounts.

Duplex removal

1. Remove the right side cover. See **“Right side cover removal”** on page 4-80.
2. Remove the LVPS/HVPS. See **“LVPS/HVPS removal”** on page 4-37.
3. Remove the three screws (A) from the shield.

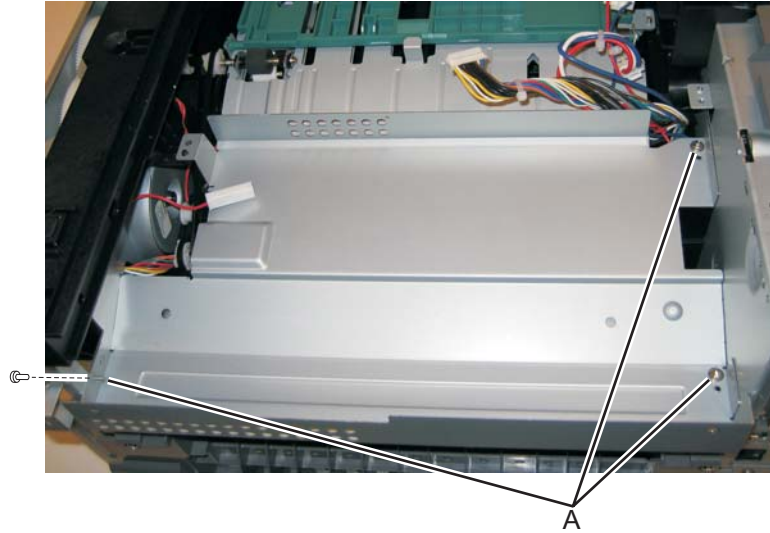

4. Remove the four screws (B) from the duplex.

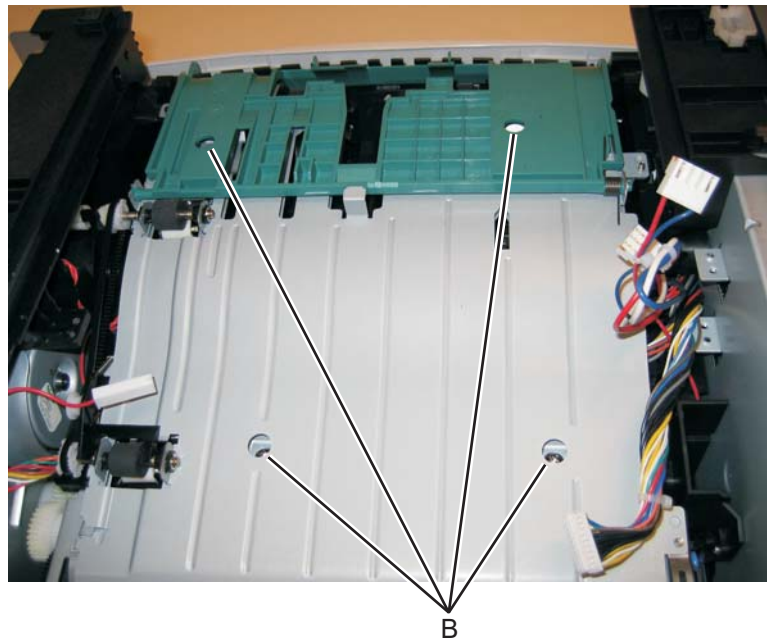

5. Lift the duplex slightly, push to the left, and tilt to clear the right side of the printer.

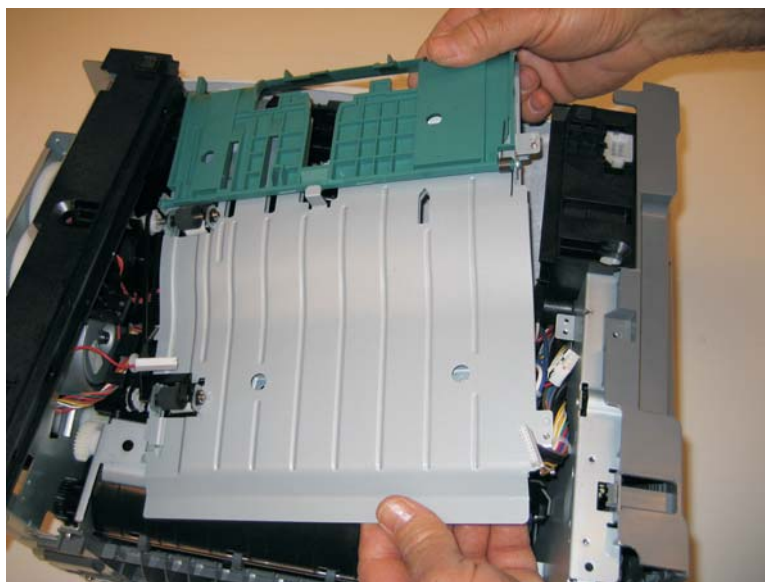

6. Remove the duplex.

Duplex/main motor gear drive interface removal

1. Remove the LVPS/HVPS. See **“LVPS/HVPS removal”** on page 4-37.
2. Remove the duplex. See **“Duplex removal”** on page 4-19.
3. Remove the main motor gear drive. See **“Main motor gear drive removal”** on page 4-40.
4. Remove the e-clip (A) from the gear.

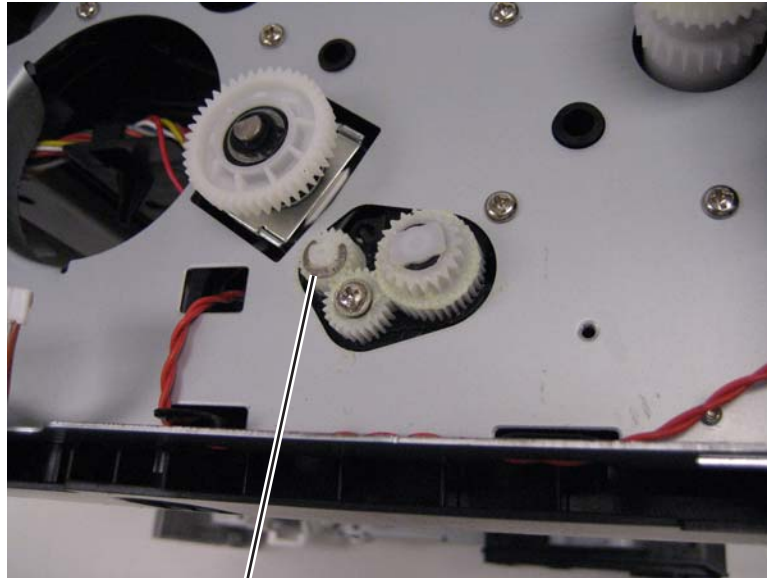

A

5. Remove the gear (B) and gear shaft (C).

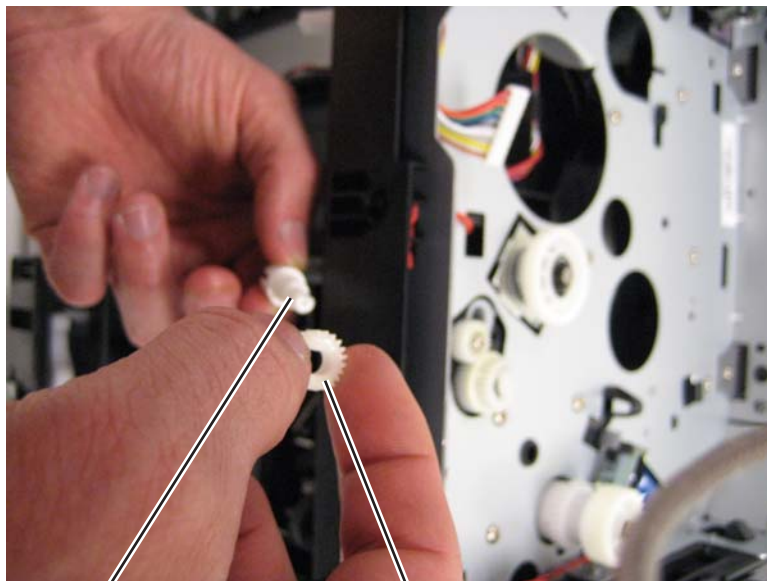

C

B

6. Remove the screw (D) from the gear (E).

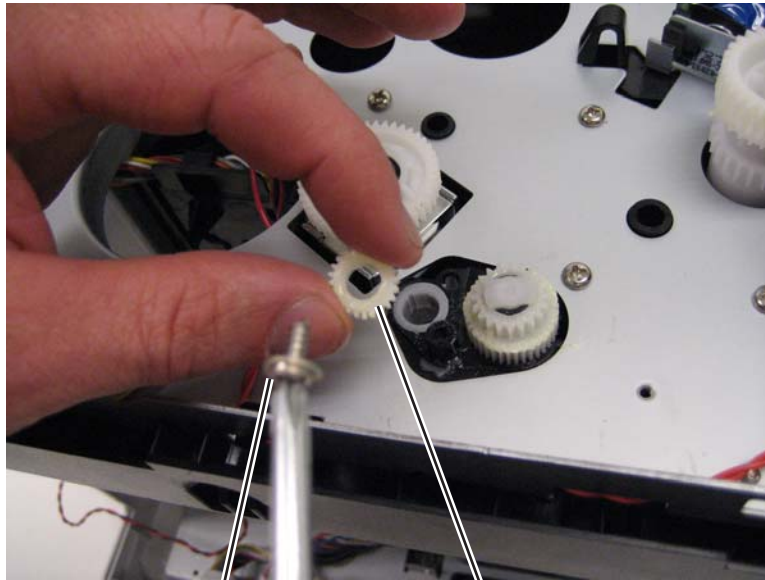

D

E

7. Remove the plastic bushing (F).

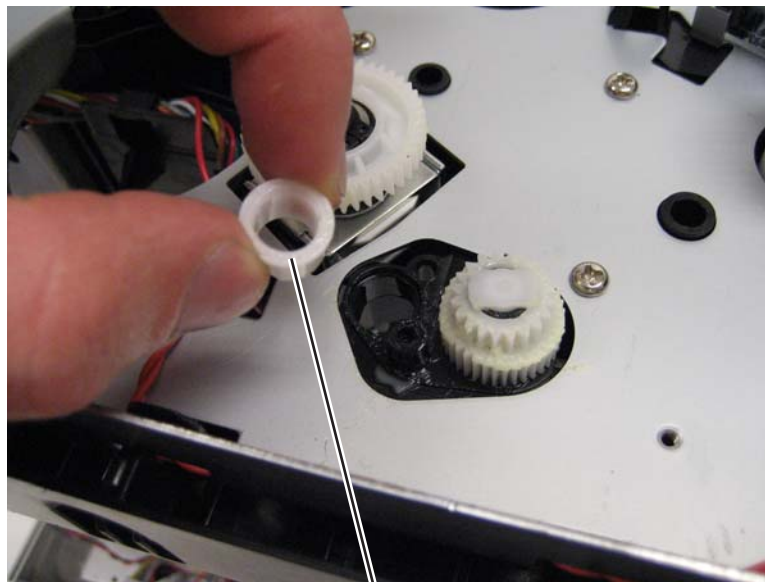

F

8. Use a screwdriver to pop the retainer clip (G) loose from the gear.

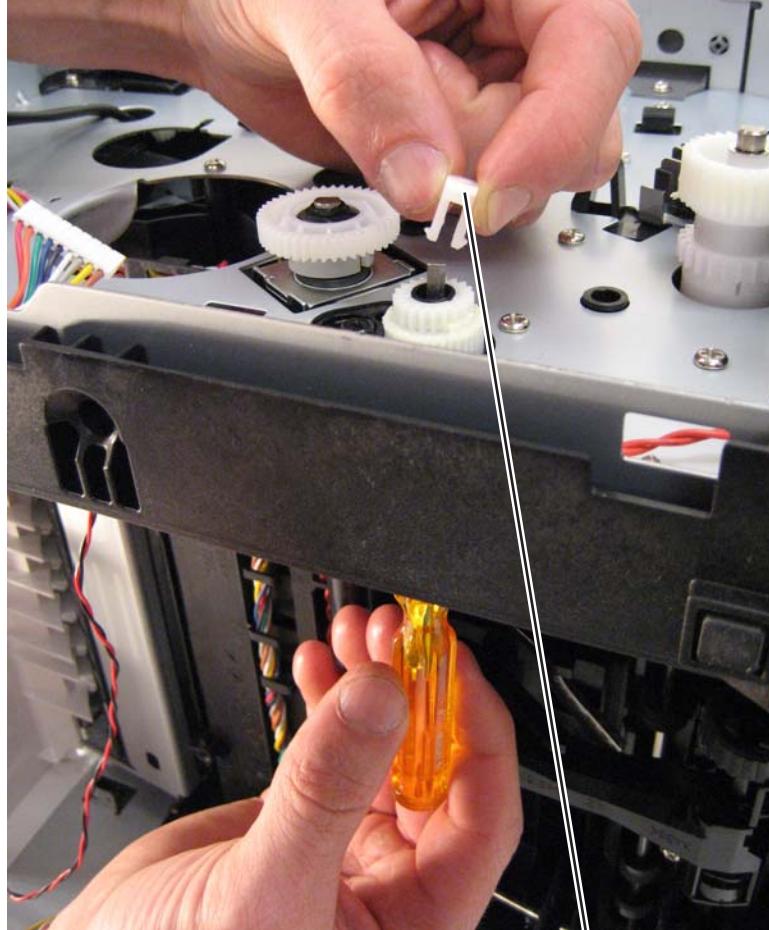

G

9. Remove the gear (H).

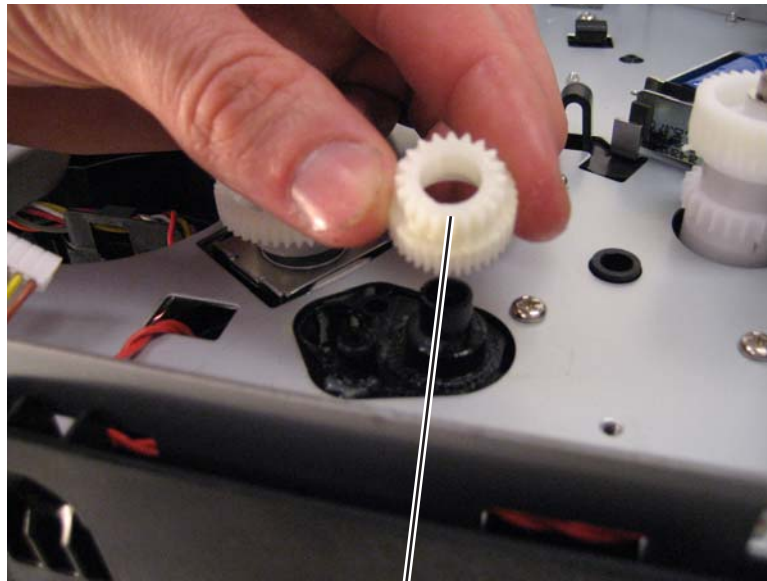

H

Fan removal

1. Remove the right side cover. See **“Right side cover removal”** on page 4-80.
2. Disconnect the cable (A) from the engine board, and remove the two screws (B) holding the fan to the right side frame.

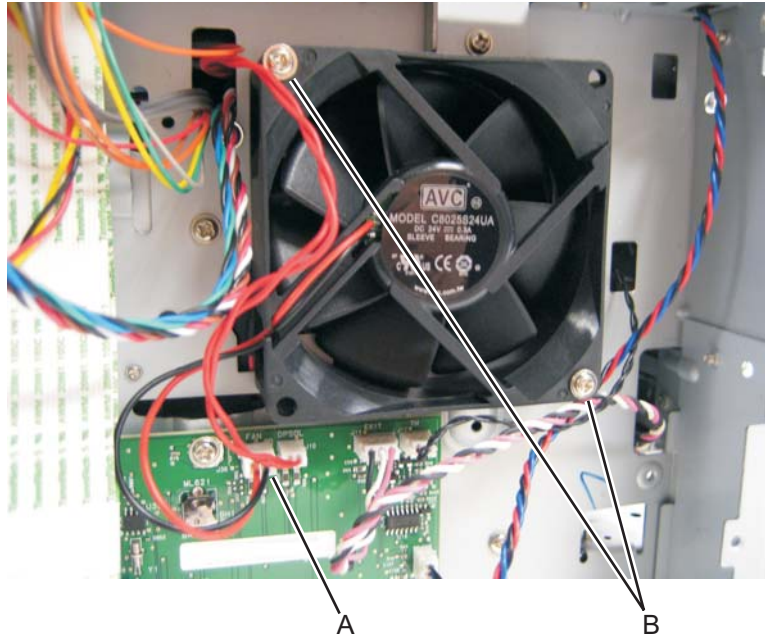

3. Remove the fan.

Front access door removal

1. Remove the front door access cover. See **“Front door access cover removal”** on page 4-34.
2. Remove the left side cover. See **“Left side cover removal”** on page 4-33.
3. Remove the upper front guide assembly. See **“Upper front guide assembly removal”** on page 4-85, steps 1-3.
4. Close the front access door.
5. While closing the MPF cover, pull up on the MPF by the steel shaft until the MPF lifts from its hinges.



6. Disconnect the MPF from the lower front cover.

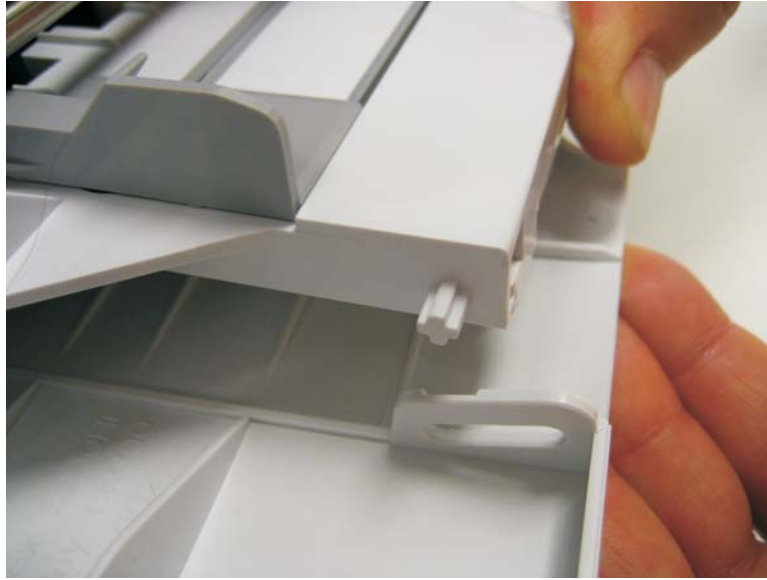

7. Disconnect the fuser link (A) from the front access door.

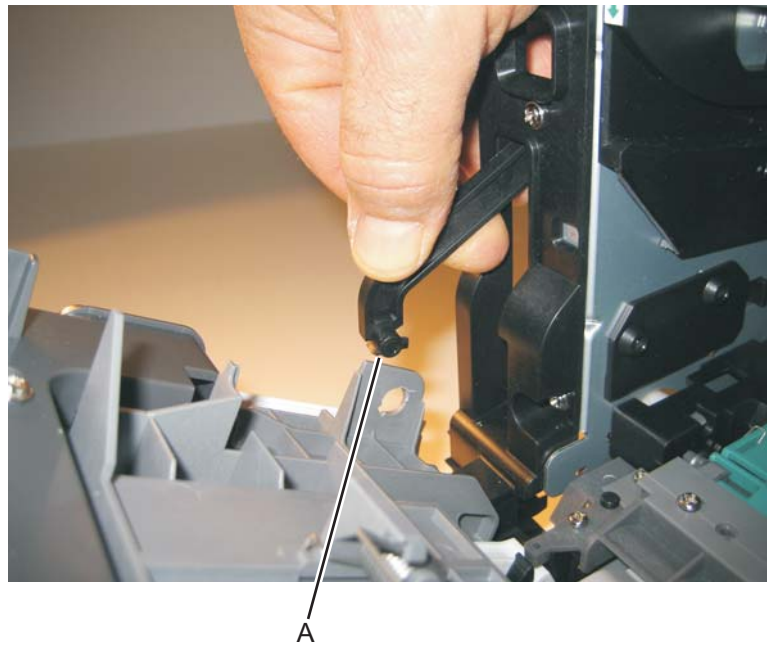

8. Disconnect the front access door from its hinges, and remove.

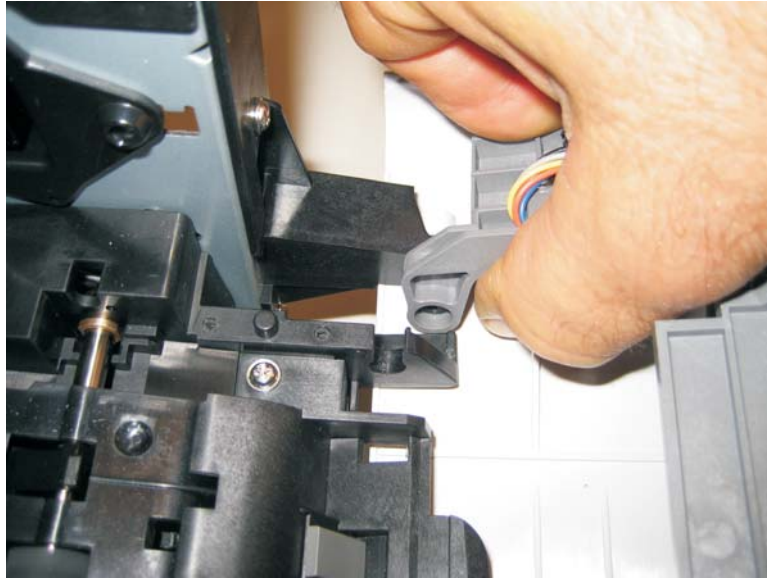

Installation note:

- a. Install a new front access door at its hinges.
- b. Connect the fuser link.
- c. Remove the two screws (D).
- d. Slide the latch to the left to free it, and then rest it on the door. Keep the spring in place.
- e. Finish tightening the screws (F), and reinstall the remaining parts.

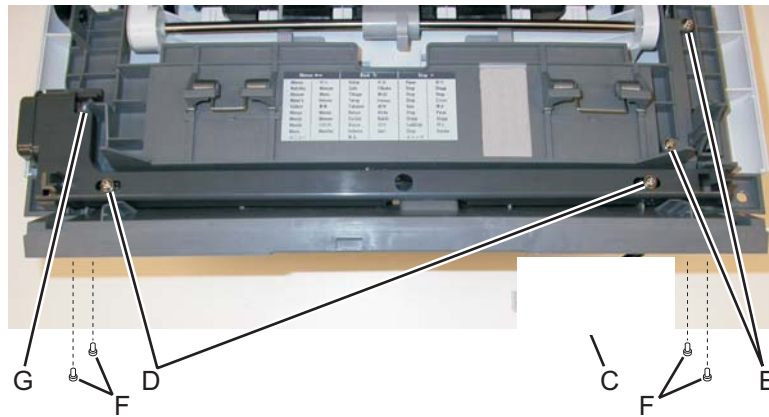

Fuser removal



1. Remove the rear exit guide. See **“Rear exit guide assembly with sensor and reversing solenoid removal” on page 4-78.**
2. Remove the two screws (A).

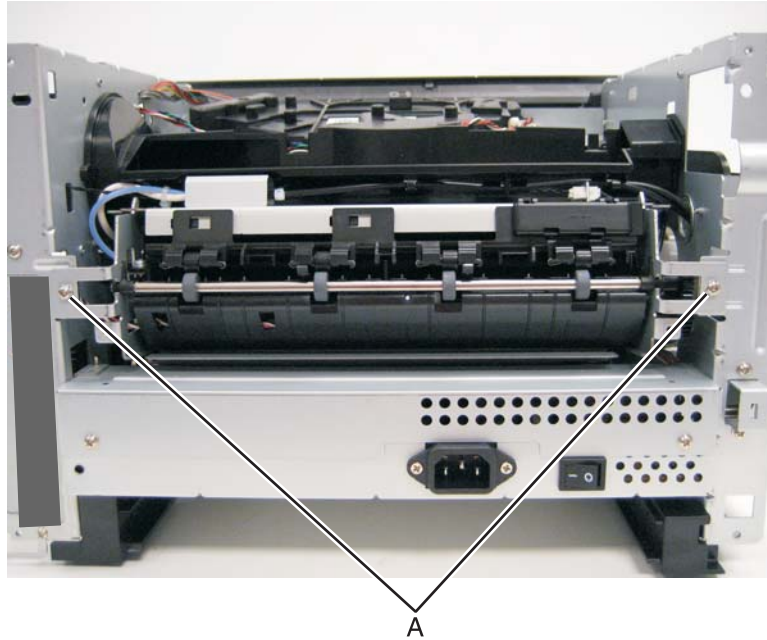

3. Partially pull the fuser forward for better access.

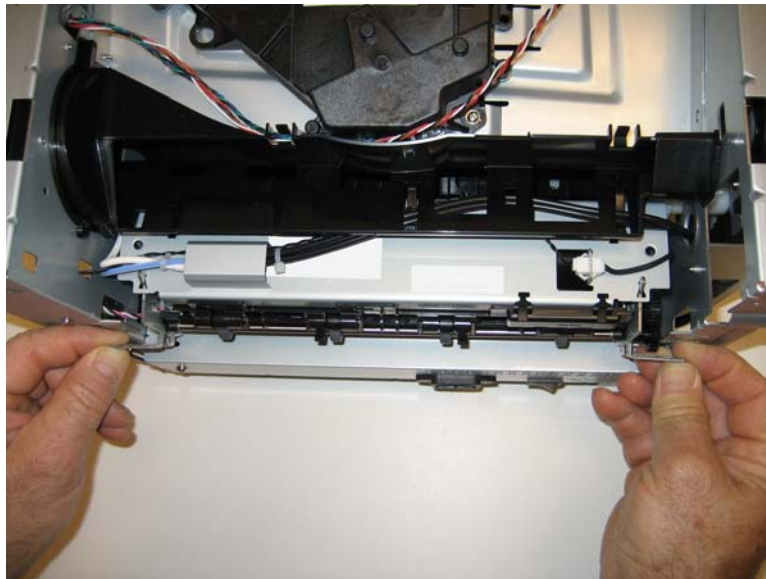

4. Push in on the cable connector cover (B), and remove.

5. Disconnect the AC cable (C).

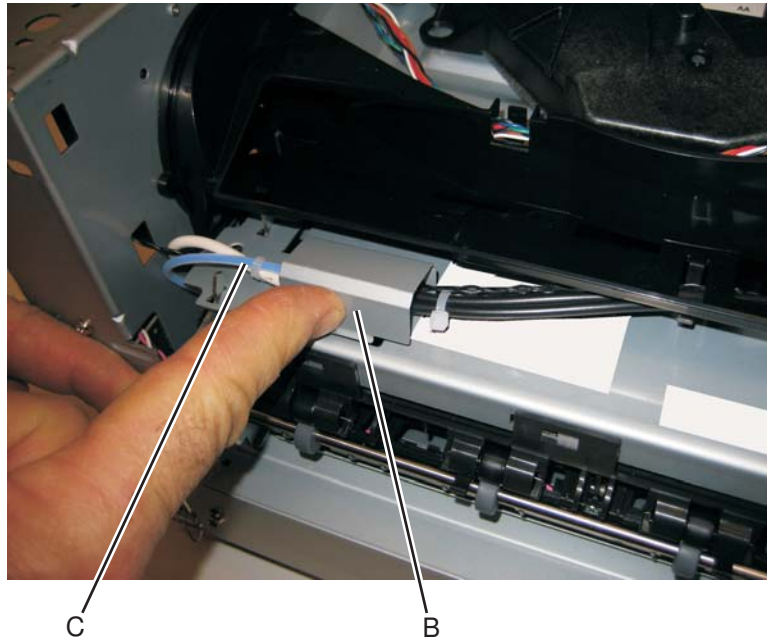

6. Disconnect the thermistor cable (D).

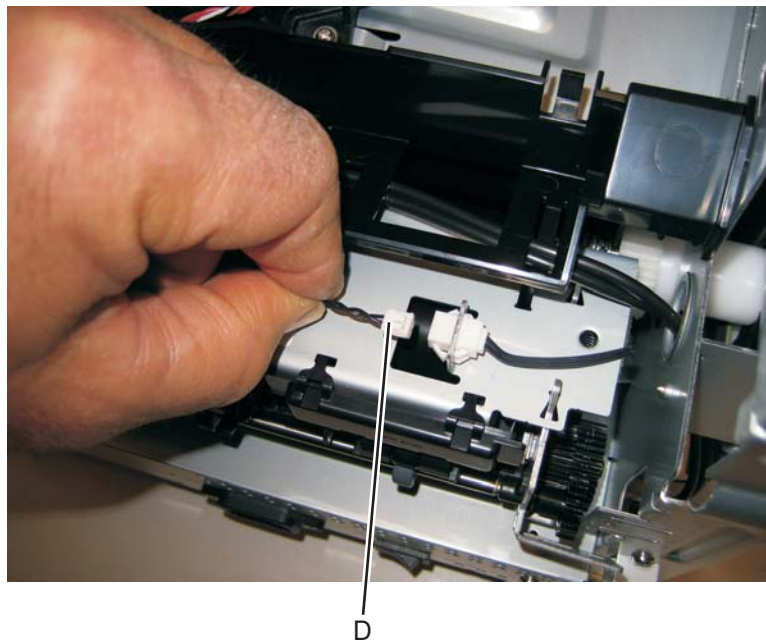

7. Disconnect the exit sensor cable (E) from the engine board.

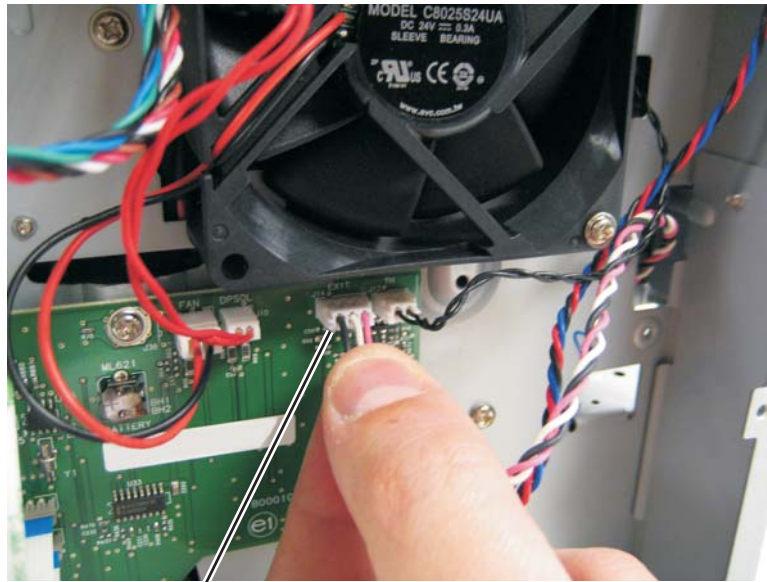

F

8. Remove the fuser.

Note:

- Be careful to not damage the gears during the fuser installation.
- Be sure to reinstall the AC cable during the fuser installation.

Scanner front cover removal

1. Use a flatblade screwdriver to pry the scanner front cover away from the side cover. Be careful to avoid marring the finish.



2. Carefully pull the scanner front cover away from the tub assembly.



Left side cover removal

Note:

- Leave the front door closed when removing the left side cover.
 - Make sure that the fuser cables are out of the way when removing the left side cover.
1. Remove the scanner front cover. See **“Scanner front cover removal”** on page 4-31.
 2. Move the scanner assembly to the up position.
 3. Remove the plastic screw (A) that secures the left cover to the tub assembly.

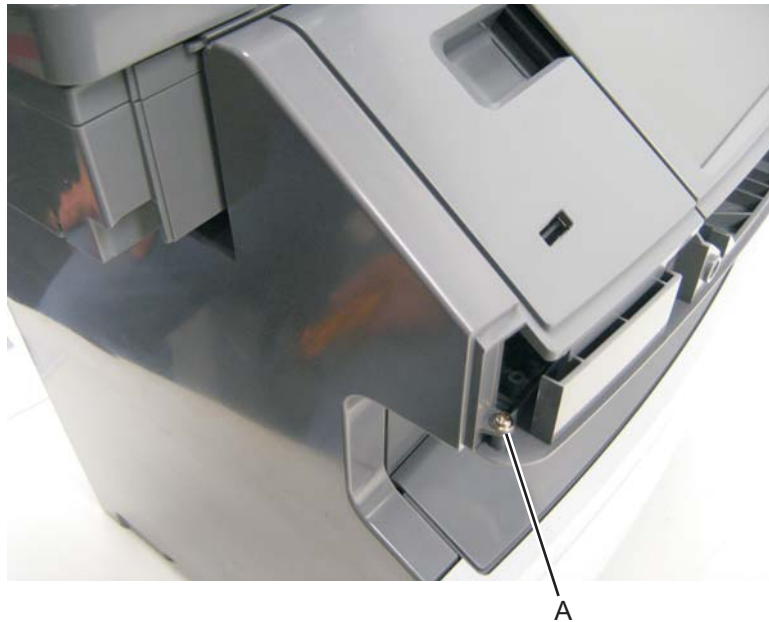

4. Remove the metal screw (B) that secures the left cover to the front of the print engine frame.

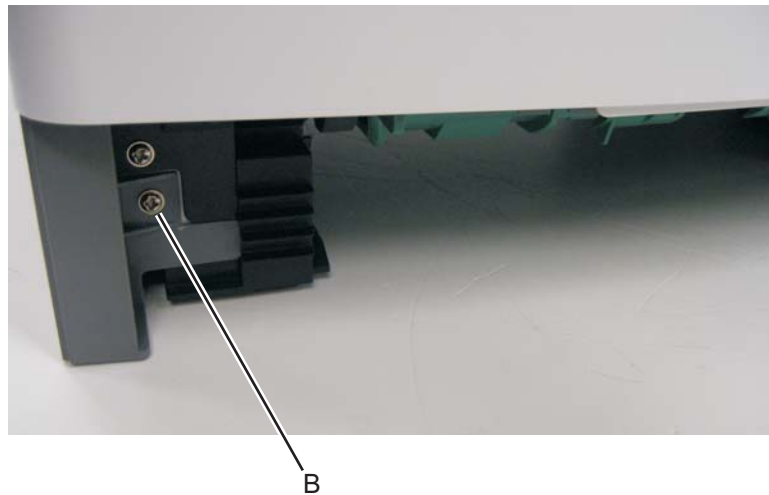

5. Move the MFP to the edge of the table.

6. Depress the two tabs (C) on the underside of the MFP.

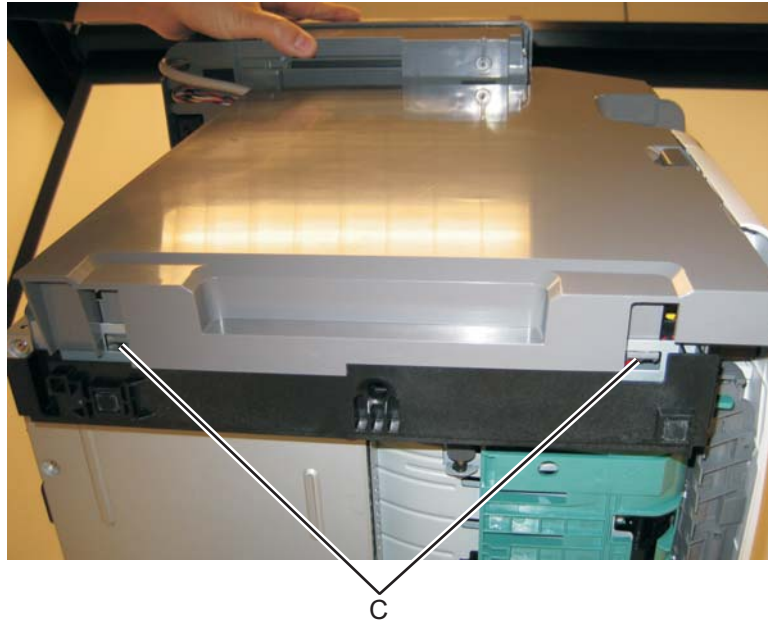

7. Lift the left cover up and pull the bottom of the cover away from the MFP.

Front door access cover removal

1. Remove bumper. See **"Nameplate cover removal" on page 4-63.**
2. Remove the two screws (A) securing the front door access cover to the front door assembly.

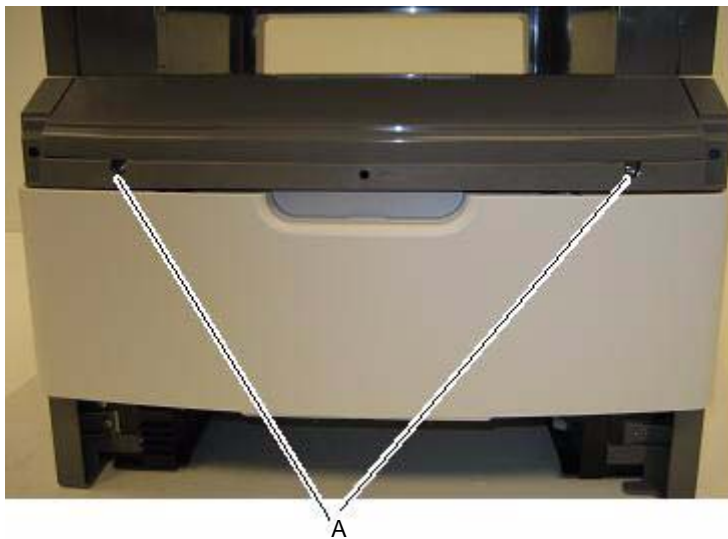

Lower front cover removal

1. Open the lower front cover.
2. Disconnect the MPF pins (A) from the right and left sides of the lower front cover.

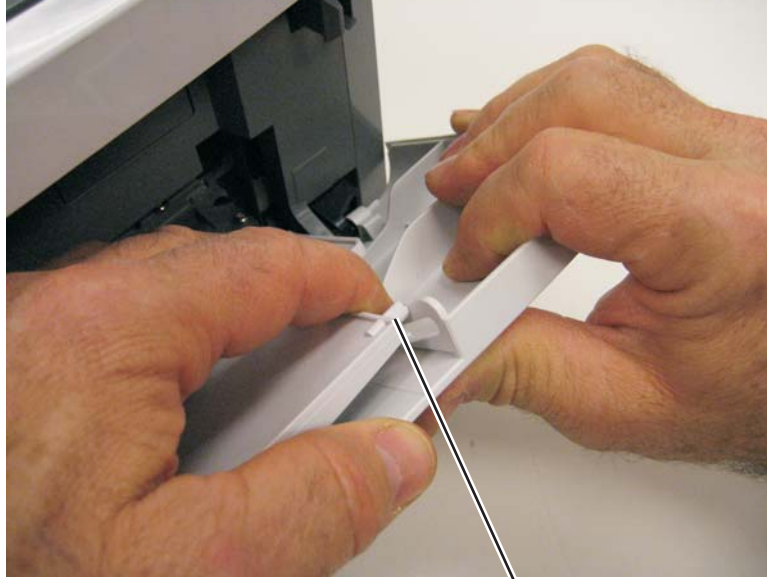

3. Flex the lower front cover, and disconnect it first from its right hinge and then from its left hinge.



Note: An alternative to step 3 is to remove the front access door, and remove the three screws from the right door mount. See [“Front access door removal” on page 4-25](#) and [“Door mount removal” on page 4-17](#).

Installation note: Use a flathead screw driver to press in on the door mount (B) while pulling on the front access door to connect the cover to the hinge (C).

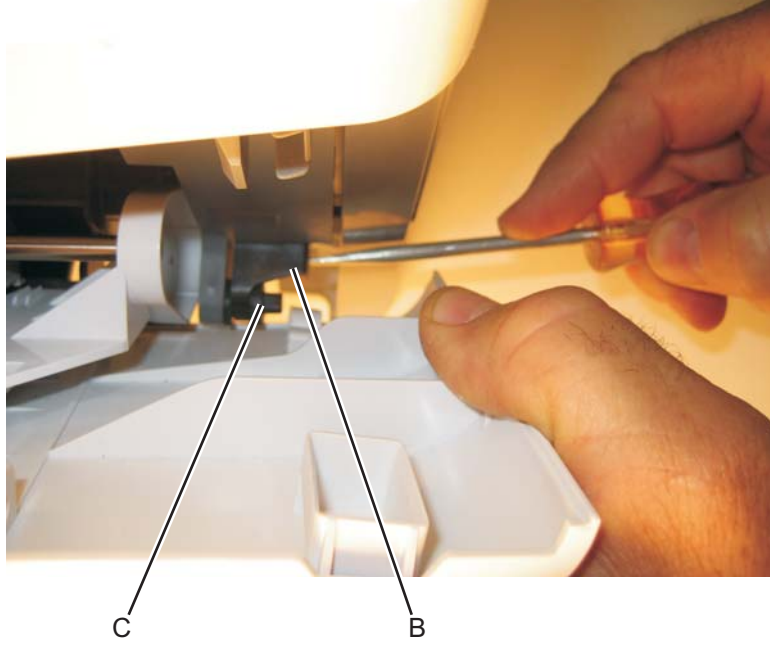

LVPS/HVPS removal



1. Remove the rear cover. See **“Rear door and lower rear cover removal”** on page 4-77.
2. Remove the left side cover. See **“Left side cover removal”** on page 4-33.
3. Place the printer on its top with the rear facing you.

Note: Be careful to not mar the finish of the printer.

4. Remove the two screws (A) from the right rear foot assembly.

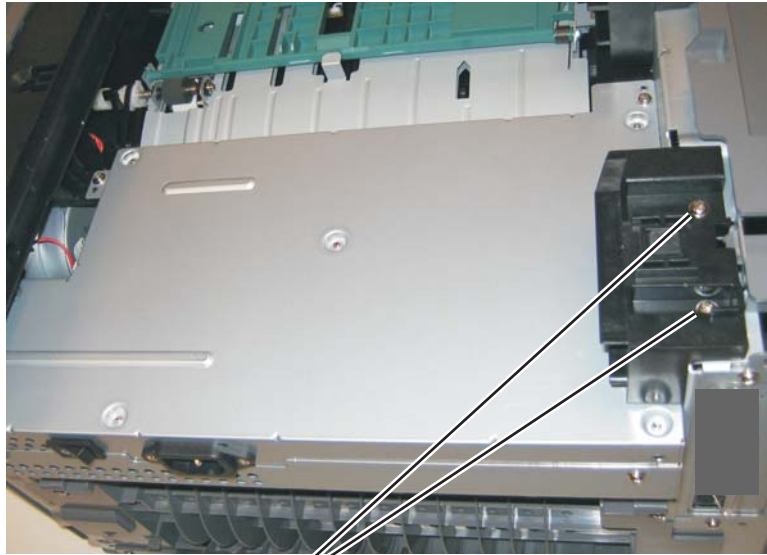

A

5. Disconnect the fuser power cable (B).



B

6. Remove the four screws (C) from the LVPS/HVPS shield.

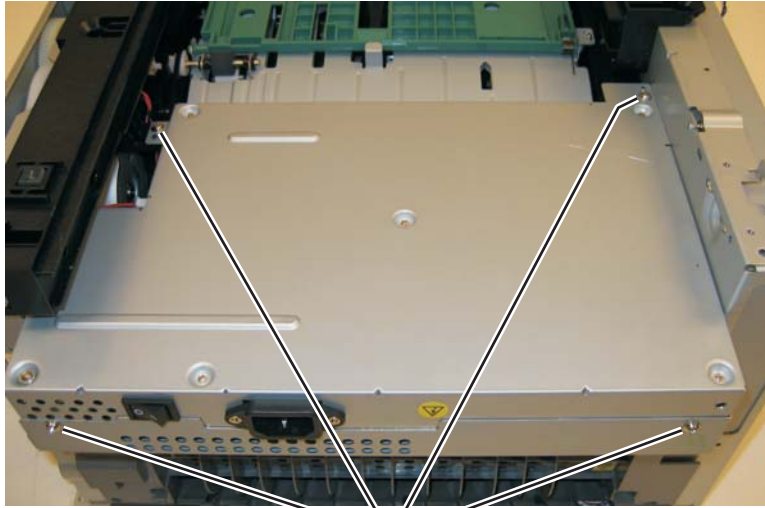

7. Lift the LVPS/HVPS, and disconnect the three cables (D).

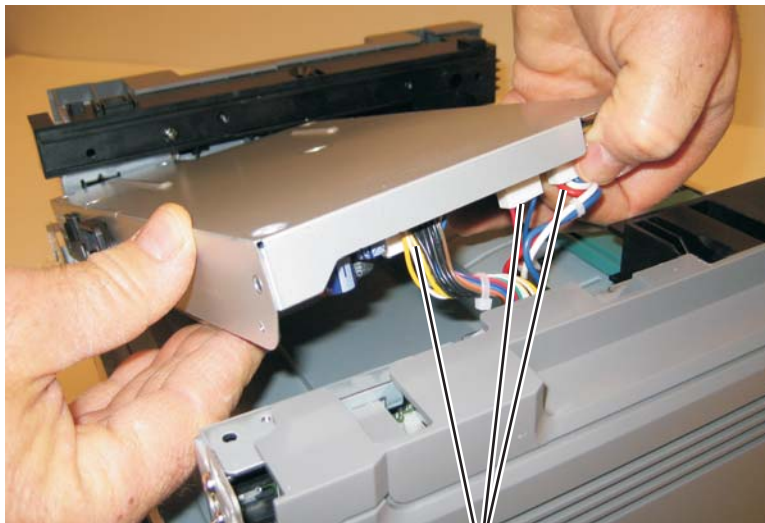

Note: Squeeze the clip to remove the cables from their connectors (E).

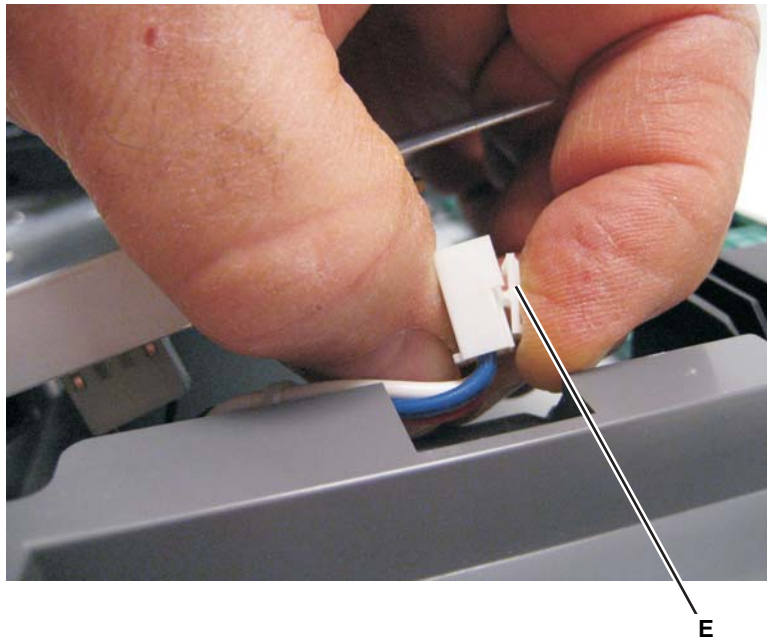

8. Disconnect the transfer roll cable (F).

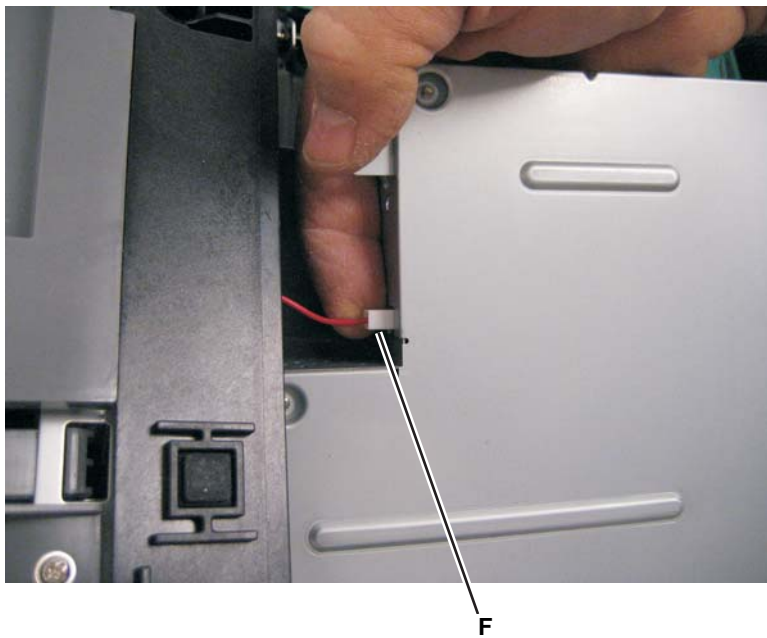

9. Lift and remove the LVPS/HVPS.

Main motor gear drive removal

1. Remove the left side cover. See **“Left side cover removal”** on page 4-33.
2. Disconnect the fuser link (A) from the front access door.

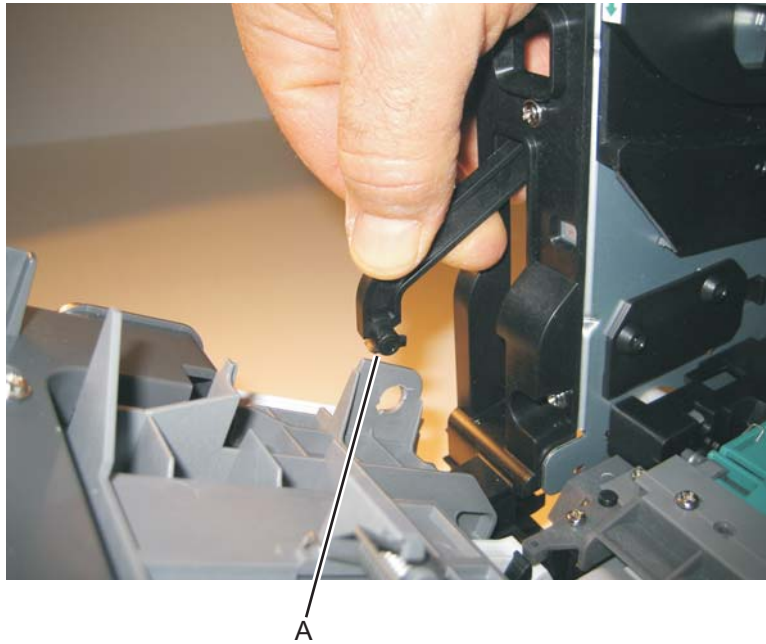

3. Place the printer on its right side.
- Note:** Be careful to not mar the finish of the printer.
4. Remove the four screws (B) from the main motor gear drive.

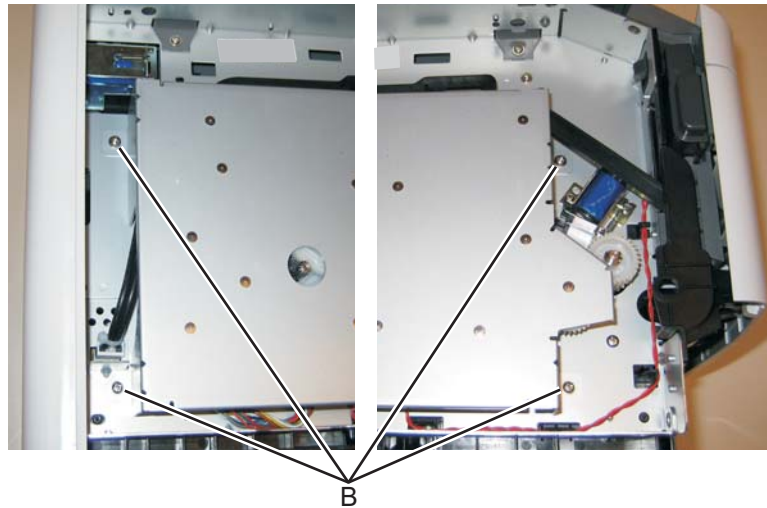

5. Lift the gear drive, and disconnect the main motor gear drive cable (C).

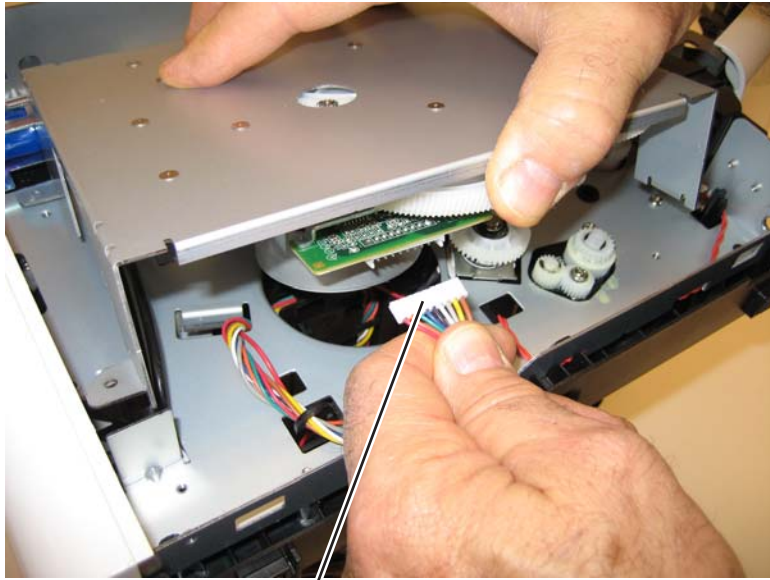

C

6. Remove the main motor gear drive.

Manual feed clutch removal

1. Remove the left side cover. See **“Left side cover removal”** on page 4-33.
2. Open the front access door, and disconnect the fuser link (A).

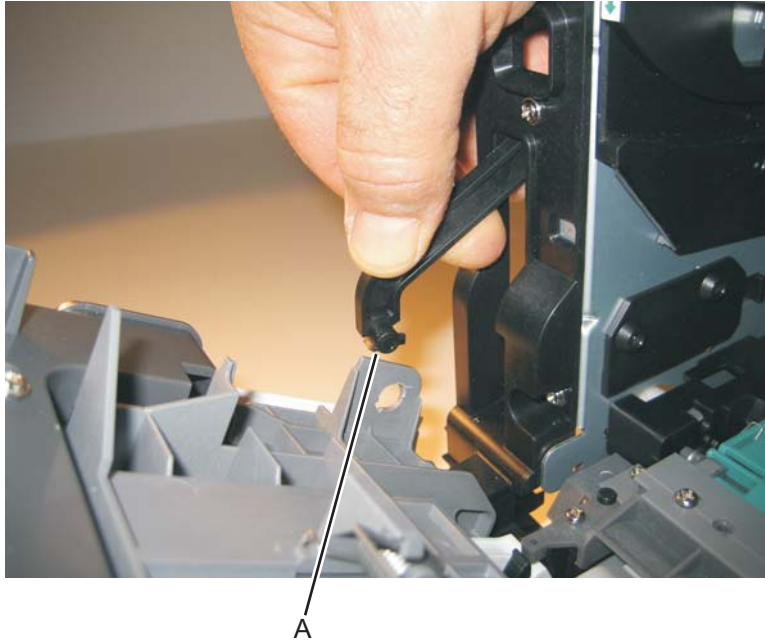

3. Place the printer on its right side.
- Note:** Be careful to not mar the finish of the printer.
4. Remove the four screws (B) from the main motor gear drive.

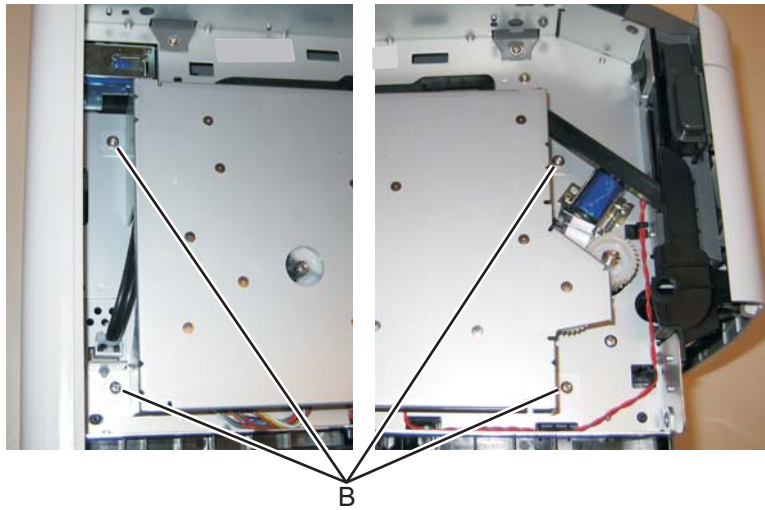

5. Rotate the main motor gear drive enough to access the manual feed solenoid.

6. Use a screwdriver to remove the e-clip (C) from the manual feed clutch.

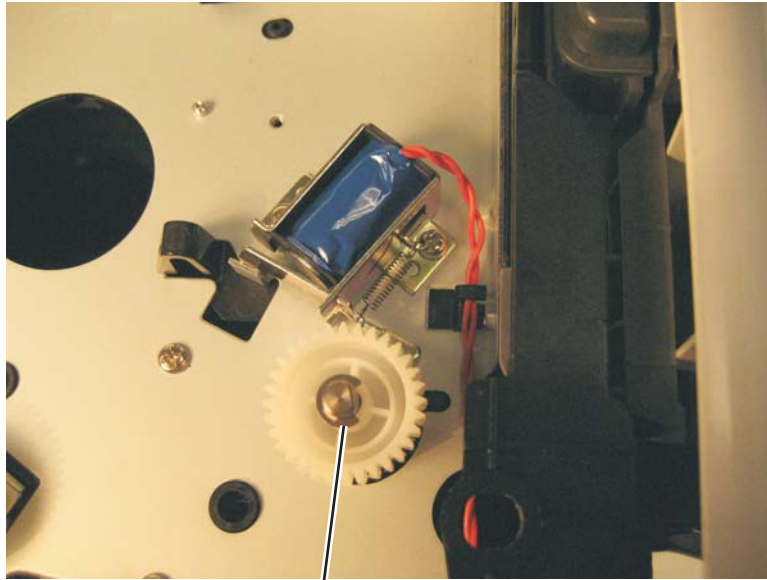

C

7. Remove the manual feed clutch (D).

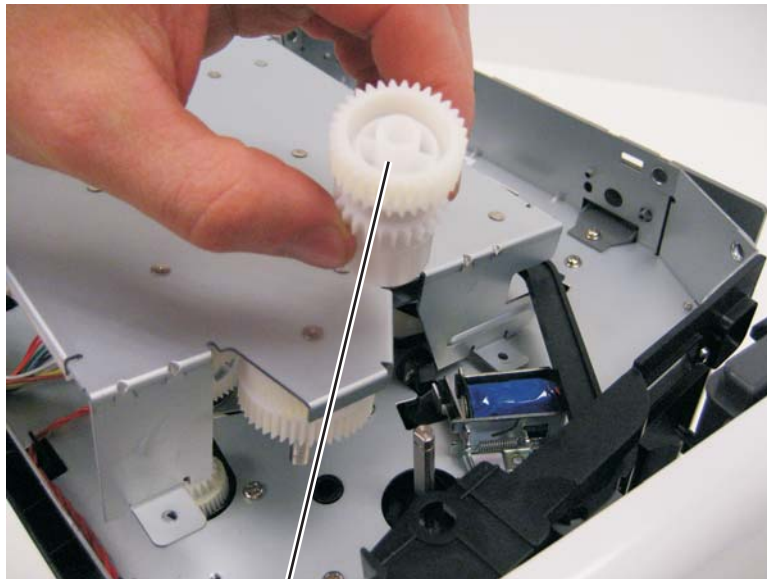

D

Manual feed solenoid removal

1. Remove the left side cover. See **“Left side cover removal” on page 4-33.**
2. Remove the duplex. See **“Duplex removal” on page 4-19.**
3. Open the front access door, and place the printer on its right side.

Note: Be careful to not mar the finish of the printer.

4. Remove the two screws (A).

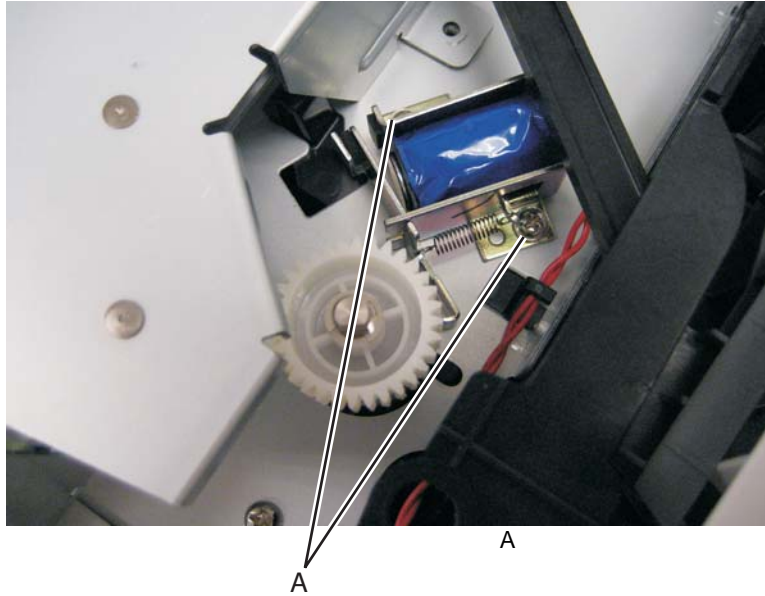

5. Remove the three screws (B) from the left door mount.



B

6. Lift and remove the left door mount (C) away from the side frame, and unroute the cable (D) with a spring hook.
7. Reinstall the left door mount, and place the printer on its top.

Note: Be careful to not mar the finish of the printer.

8. Disconnect the cable (D) from J25 on the engine board.

Installation note:

- Install the two screws holding the new solenoid in place, and route the cable (D) behind the MPF clutch (E).
- After disconnecting the old solenoid cable, connect the new solenoid cable to J25 on the engine board.

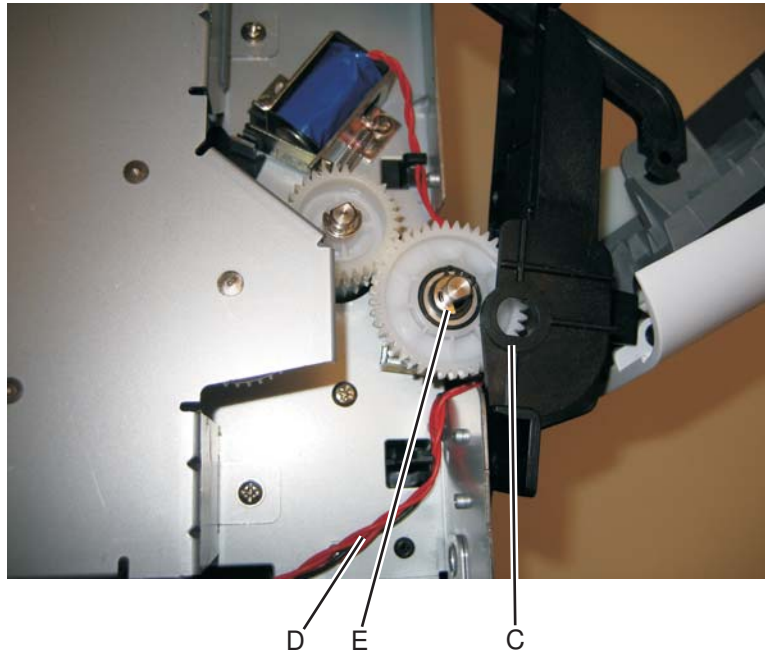

Media ACM ASM feeder removal

1. Remove the left side cover. See **“Left side cover removal”** on page 4-33.
2. Remove the LVPS/HVPS. See **“LVPS/HVPS removal”** on page 4-37.
3. Remove the duplex. See **“Duplex removal”** on page 4-19.
4. Remove the main motor gear drive. See **“Main motor gear drive removal”** on page 4-40.
5. Remove the media feed clutch. See **“Media feed clutch removal”** on page 4-50.
6. Use a screwdriver to pop the shaft retainer tab (A) loose from the ACM feed shaft.

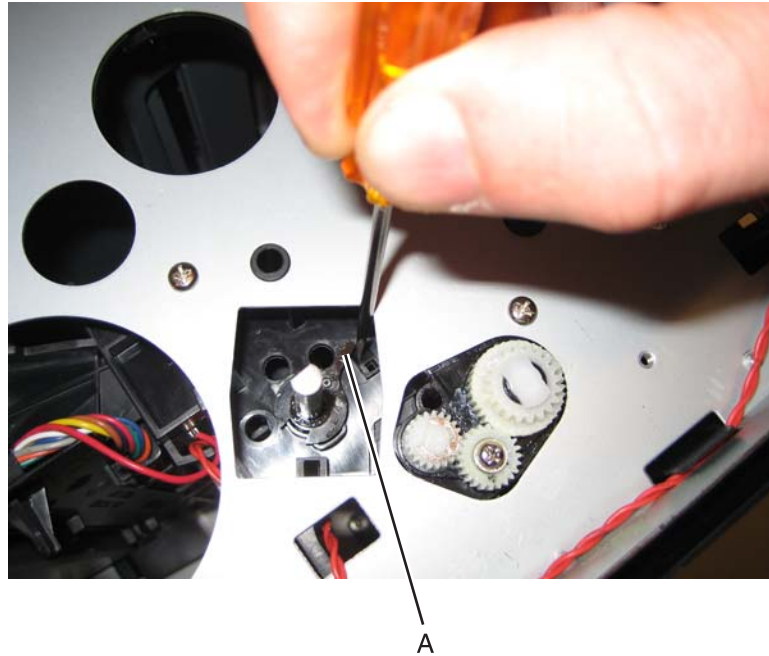

7. Use a small pair of pliers to remove the shaft retainer tab.

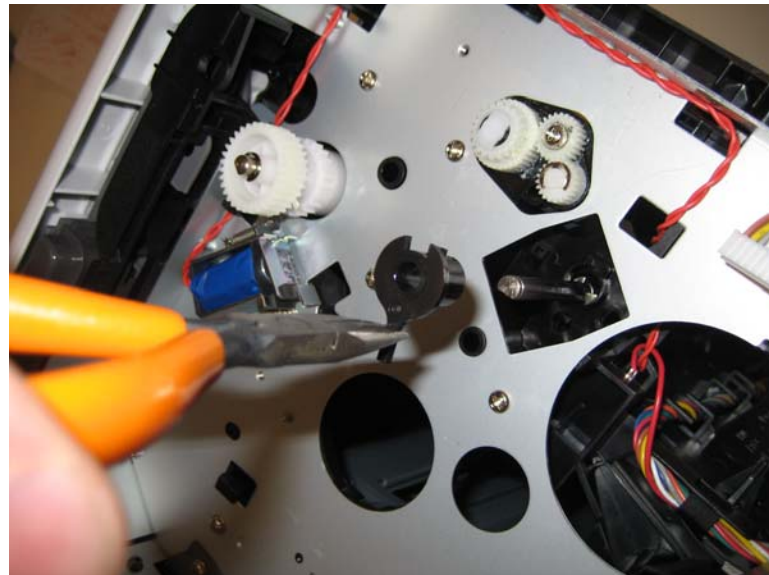

8. Use a screwdriver to pop the inner shaft lock (B) loose.

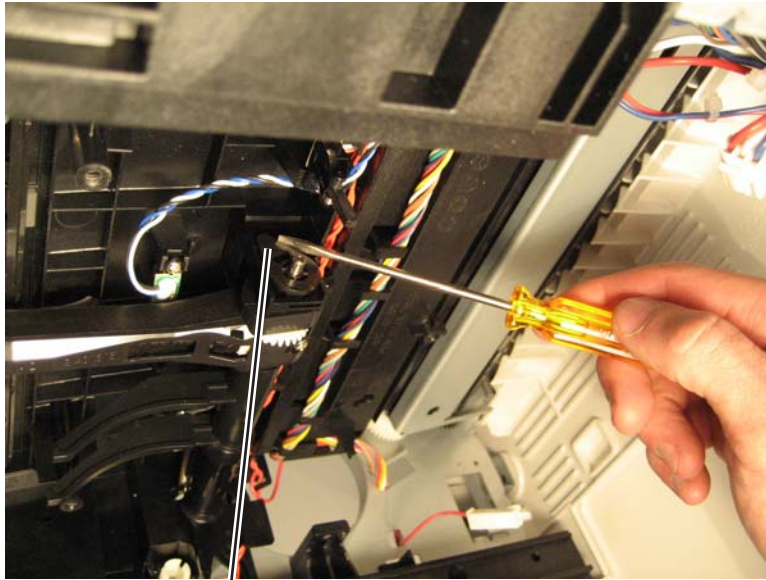

B

9. Remove the inner shaft lock (C).

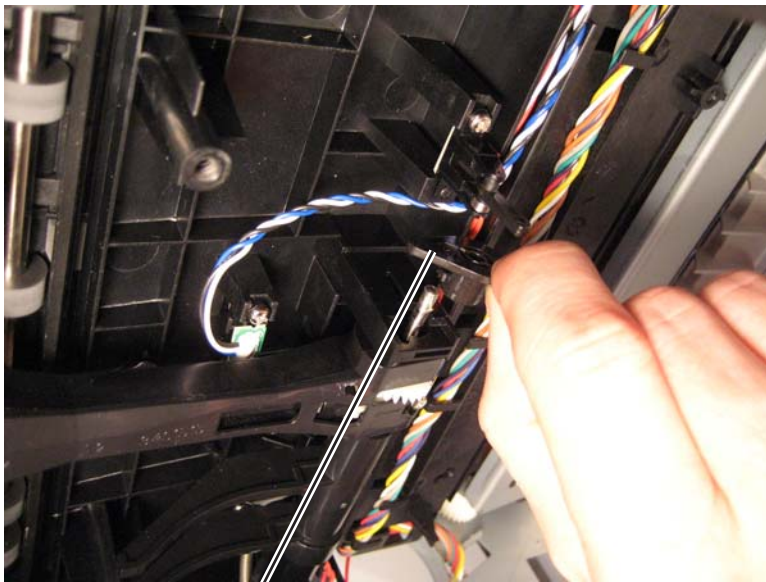

C

- 10.** Pull out the auto compensator shaft, and remove the spring (D).

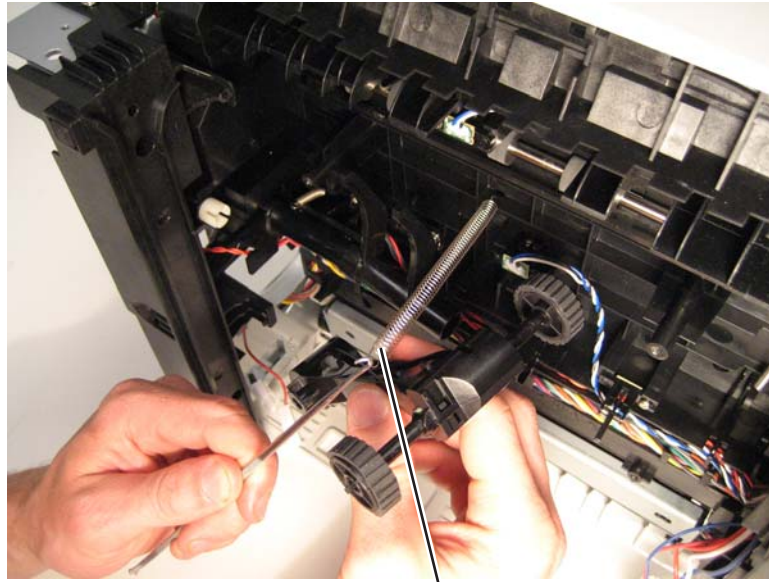

D

- 11.** Remove the auto compensator shaft.
12. Disconnect the spring (E) from the cylinder.

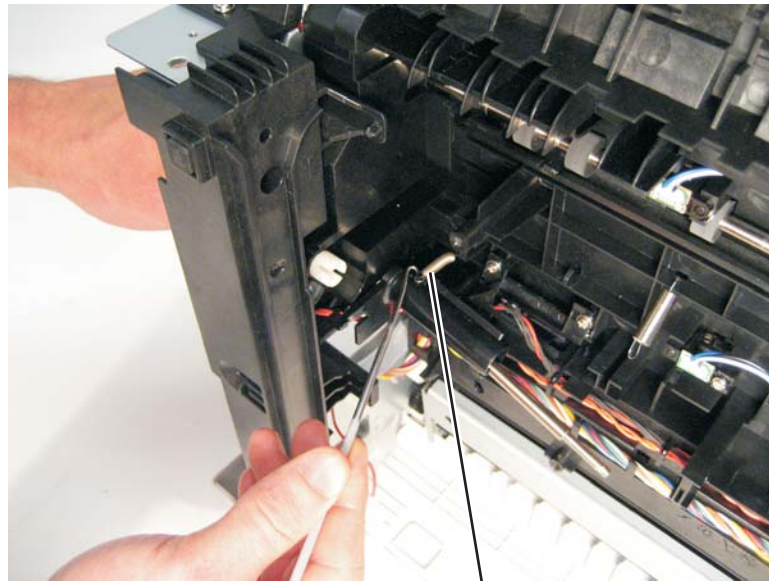

E

- 13.** Remove the media ACM ASM feeder.

Media feed clutch removal

1. Remove the left cover. See **“Left side cover removal”** on page 4-33.
2. Remove the main motor gear drive. See **“Main motor gear drive removal”** on page 4-40.
3. Carefully remove the e-clip that secures the clutch to the ACM shaft.



4. Pull up the clutch from the cavity, exposing the white tape.
5. Cut the tape to expose the wire connection to the clutch, and cut the cables at the copper leads.



6. Clean any adhesive residue from the wires.

7. Pull the clutch cable into the motor cavity. Pull up the cable to remove any slack.



8. Remove any shrink tubing that is holding the wires together.

Warning: Do not strip the insulation off the red and black wires. The connectors will not work if the insulation is removed.



Installation notes:

1. Remove the new clutch from its packaging.
2. Measure 4 inches (100 mm) from the clutch, and cut the clutch cable.



3. Install the new media clutch on the ACM drive shaft.
4. Insert the red wire from the printer into the wire splice connector.

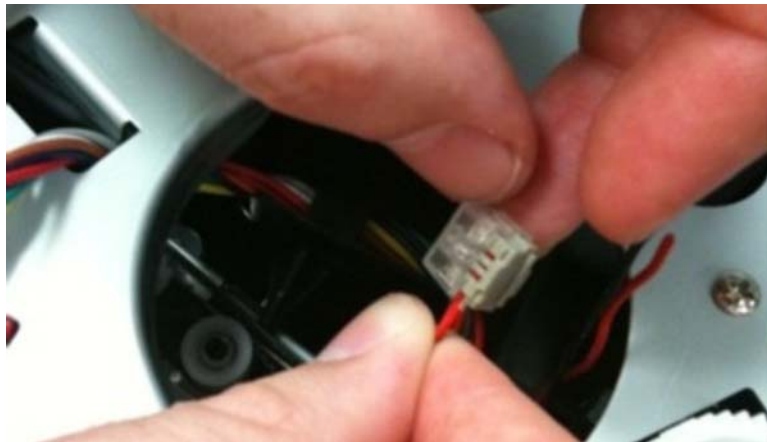

5. Insert the red wire from the clutch into the wire splice connector.

6. Using a pair of pliers, squeeze the connector to secure the red wires in place.
Note: Check the connector to make sure that the gray connector is pressed flush to the bottom of the wire splice.

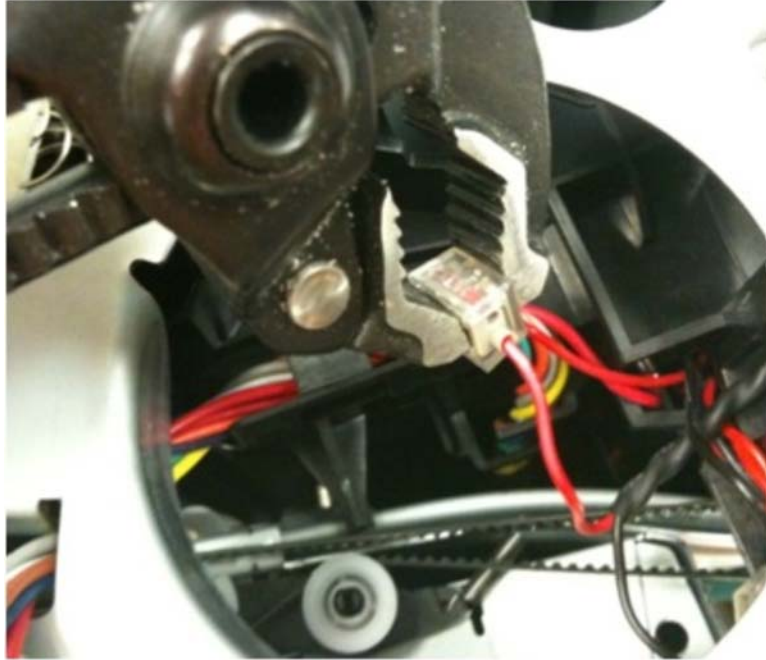

7. Repeat steps four through six for the black wires on the clutch and printer.
8. Tuck the connectors securely above the duplex guide.
Note: If needed, use a wire tie to secure the cable in place. Make sure the tie does not interfere with the paper path.



9. Reinstall the gear drive.
10. Print the menu pages to test the printer.
11. Reinstall the left cover.

Media manual input sensor

1. Remove the right side cover. See **“Right side cover removal”** on page 4-80.
2. Remove scanner assembly.
3. Place the machine on its side.

Note: Be careful to not mar the finish of the printer.

4. Disconnect the sensor cable (A) from J23 (MPFS) on the engine board.

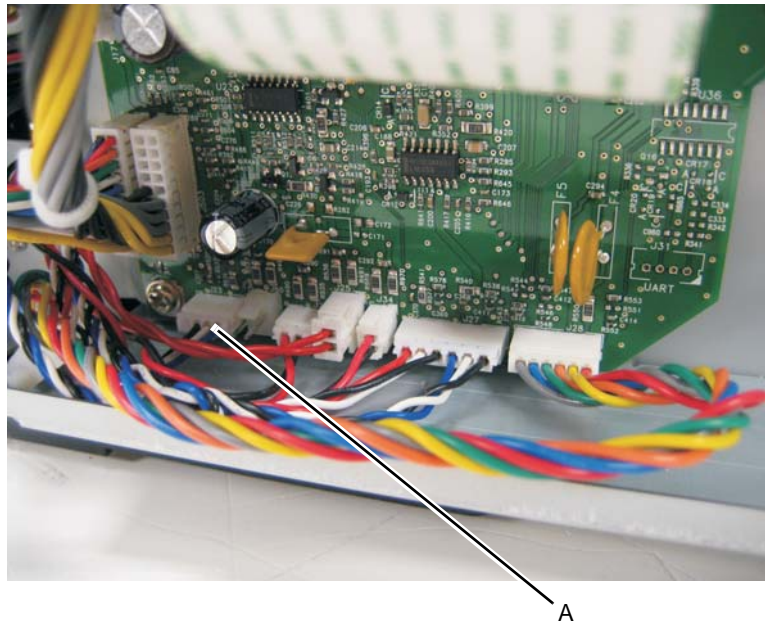

5. Remove the screw (B) holding the sensor.

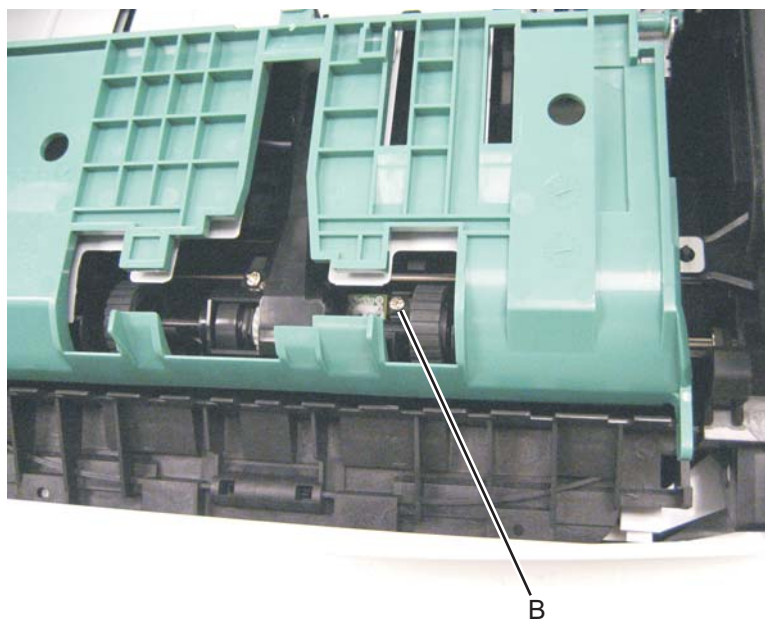

6. Free the cable from its retainers, and pull it through the opening toward the sensor mount.

Re-installation note:

- Prop open the duplex door, and insert the hook end of the spring hook through the frame opening (C) from the controller board side. Extend the hook until the sensor connector can be hooked.
- Hook the spring hook (D) to the connector (E), and pull it through the opening.

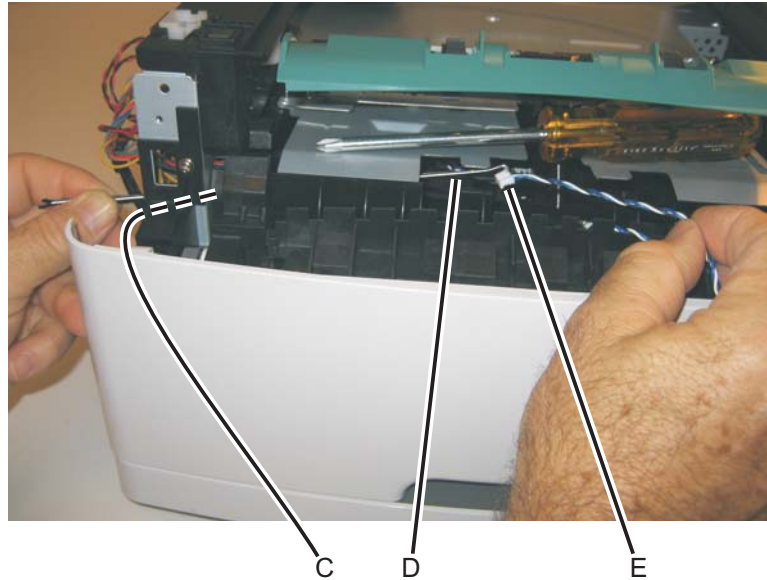

- Place the sensor into position, and reconnect the cable on the controller board.
- Using the spring hook, be sure to reroute the cable through the three retainers (F) between the sensor and side frame.

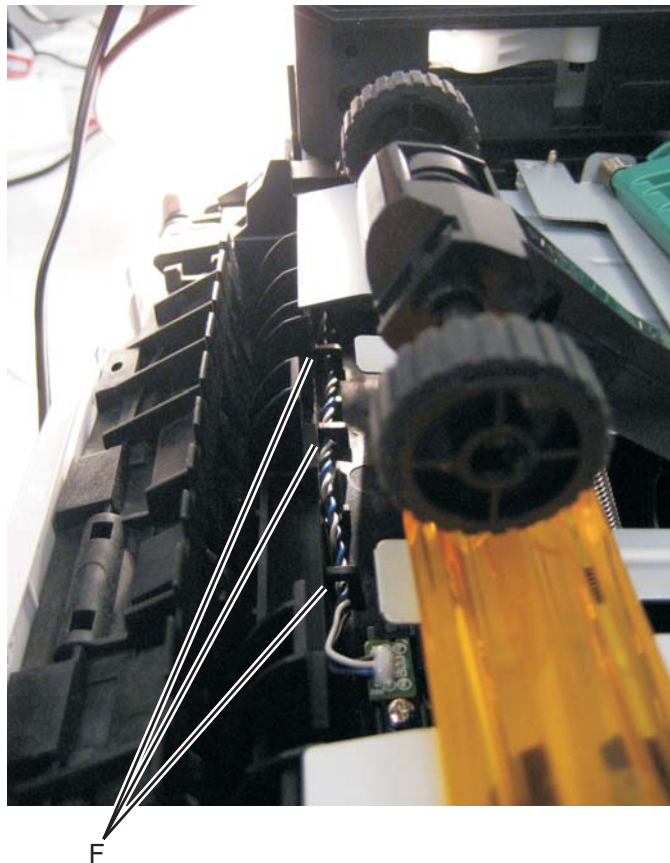

Note: If the cable is not properly installed in its retainers, then the loose cable will obstruct the paper path.

Warning: Check to make sure the duplex paper jam door is in its proper position. If it is not, then the paper tray will become lodged and the printer will need to be replaced.

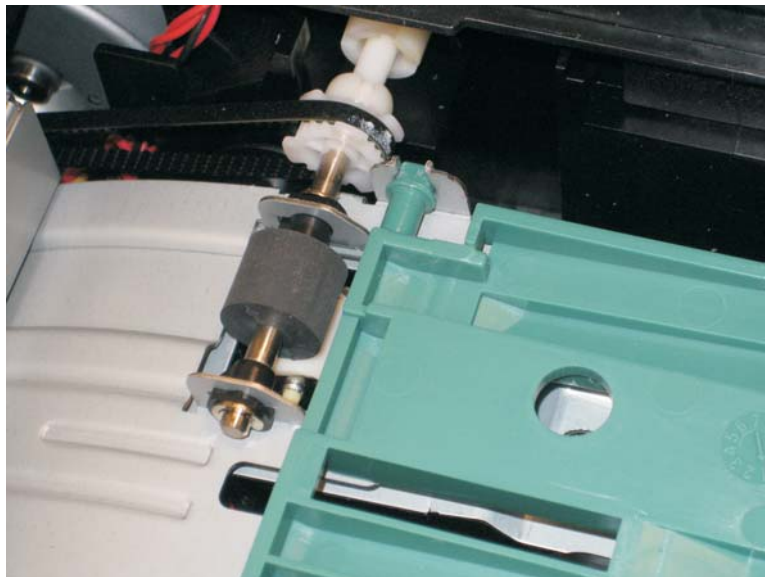

Multipurpose feeder removal

1. Open the front access door.
2. Remove the four screws (A) from the upper front guide.

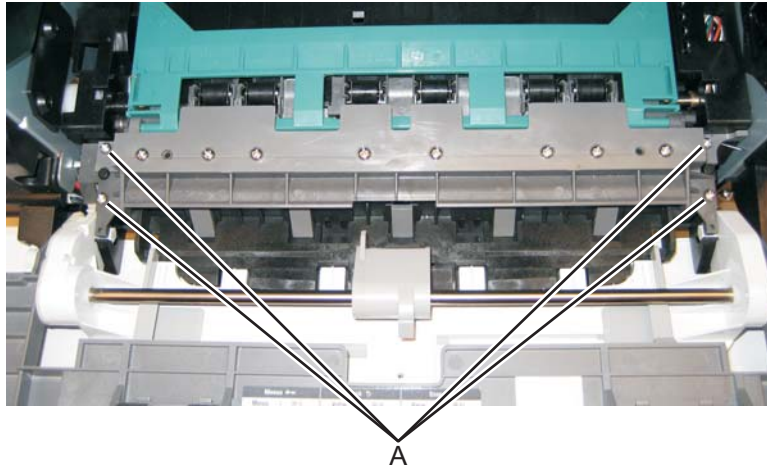

3. Remove the upper front guide.
4. Remove the two screws (B).

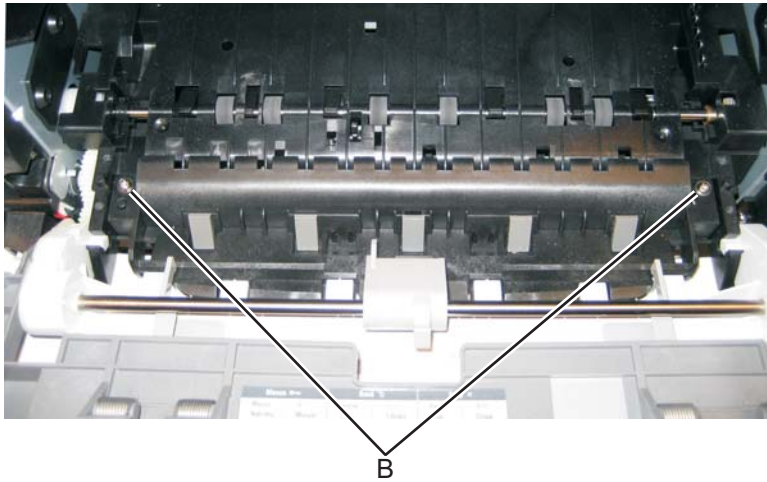

B

5. Close the front access door, and pull up on the MPF by the steel shaft until the MPF lifts from its hinges.

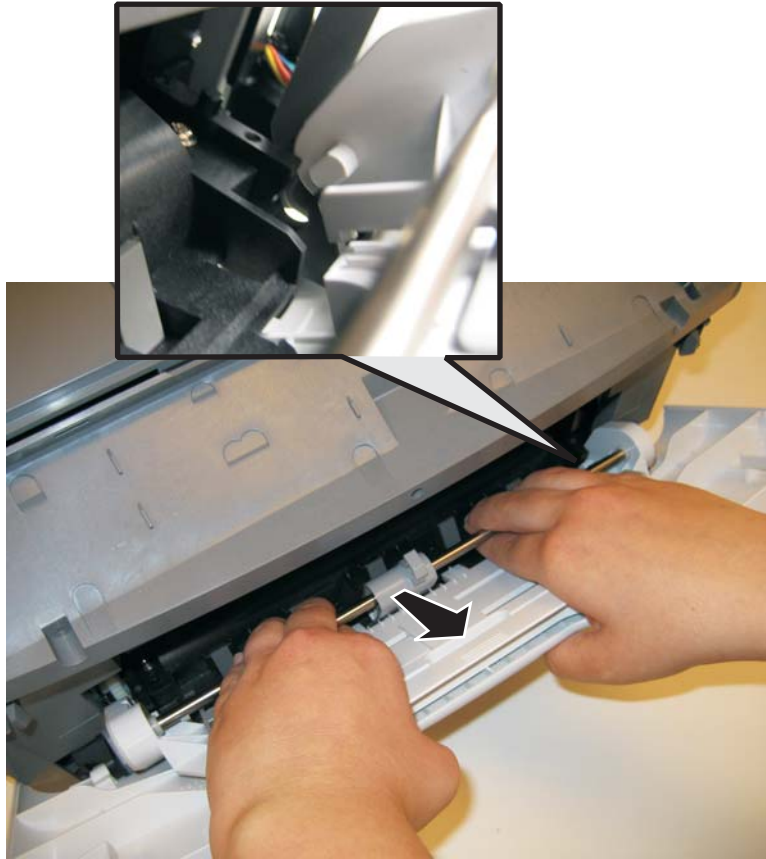

6. Disconnect the MPF from the lower front cover.

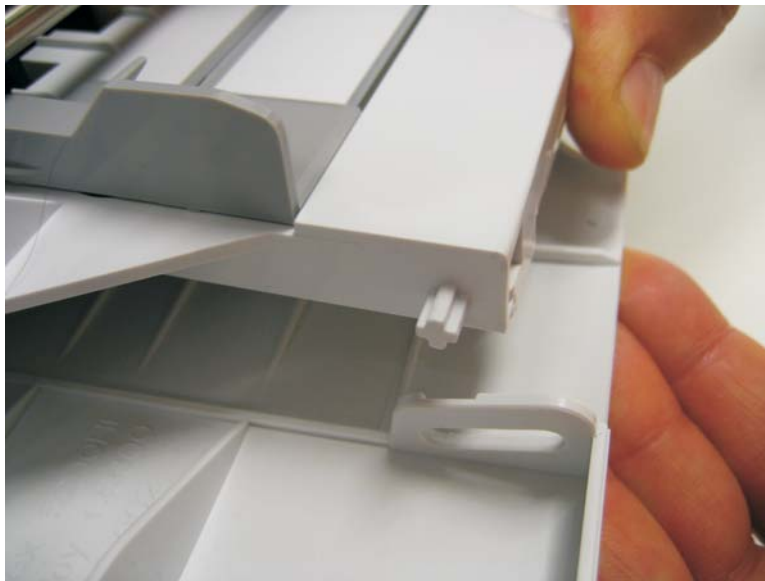

7. Open the front access door, and remove the lower paper guide.

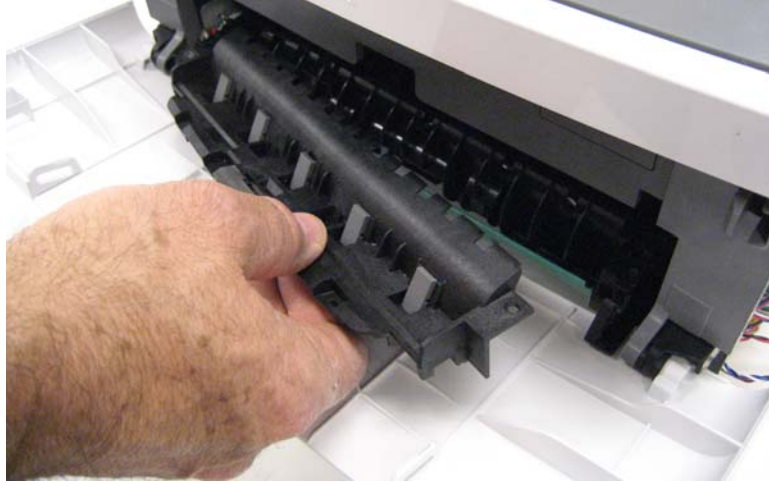

Multipurpose feeder (MPF) feed clutch removal

1. Remove the left side cover. See **“Left side cover removal”** on page 4-33.
2. Remove the duplex. See **“Duplex removal”** on page 4-19.
3. Disconnect the cable (A) from J24 on the engine board.

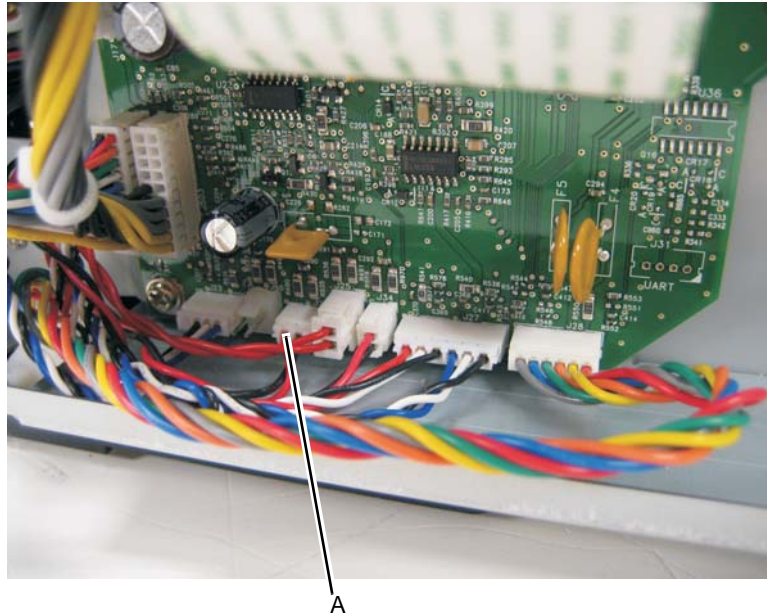

4. Place the printer on its right side.

Note: Be careful to not damage any cables or mar the finish of the printer.

5. Remove the three screws (B) from the left side of the printer.



B

6. Disconnect the left hinge (C) from the feed clutch, and remove the e-clip (D).

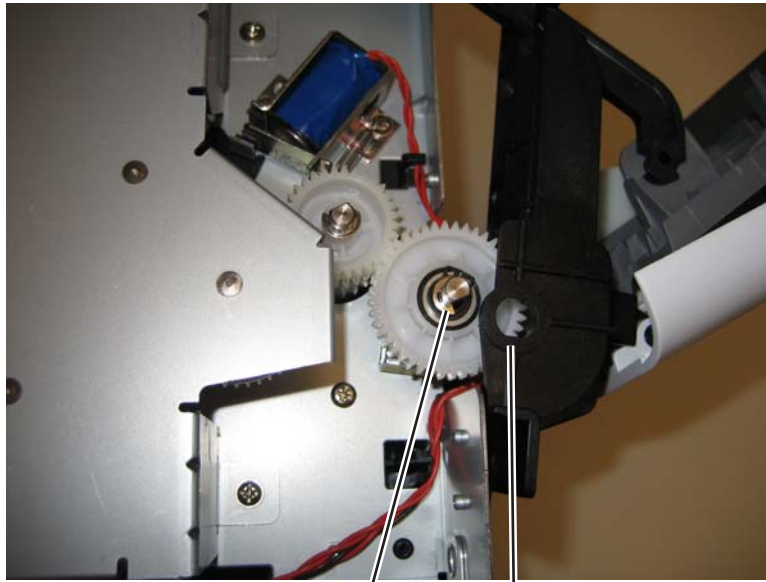

D C

7. Lift and remove the multipurpose feeder (MPF) feed clutch.

Nameplate cover removal

1. Open the front access door.
2. Remove the three screws (A).

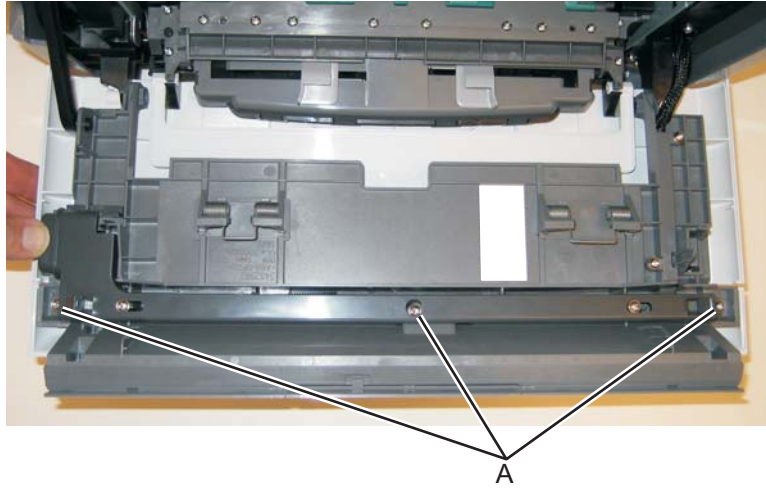

3. Remove the nameplate.

Operator panel keypad removal

1. Lift the scanner assembly to the up position.
2. Release the two tabs (A) securing the keypad to the keypad to the tub assembly.

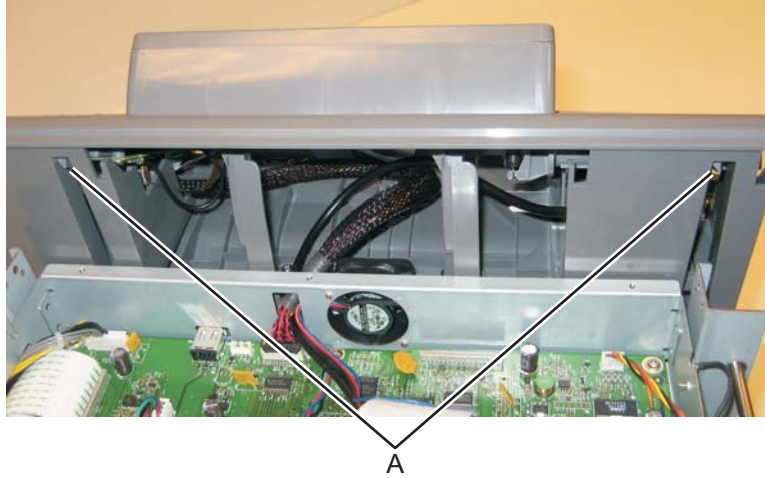

3. Disconnect the UICC cable (B) from the operator panel PCB assembly.
4. Disconnect the two ribbon cables (C) from the operator panel PCB assembly.
5. Disconnect the ground (D) on the operator panel PCB assembly.

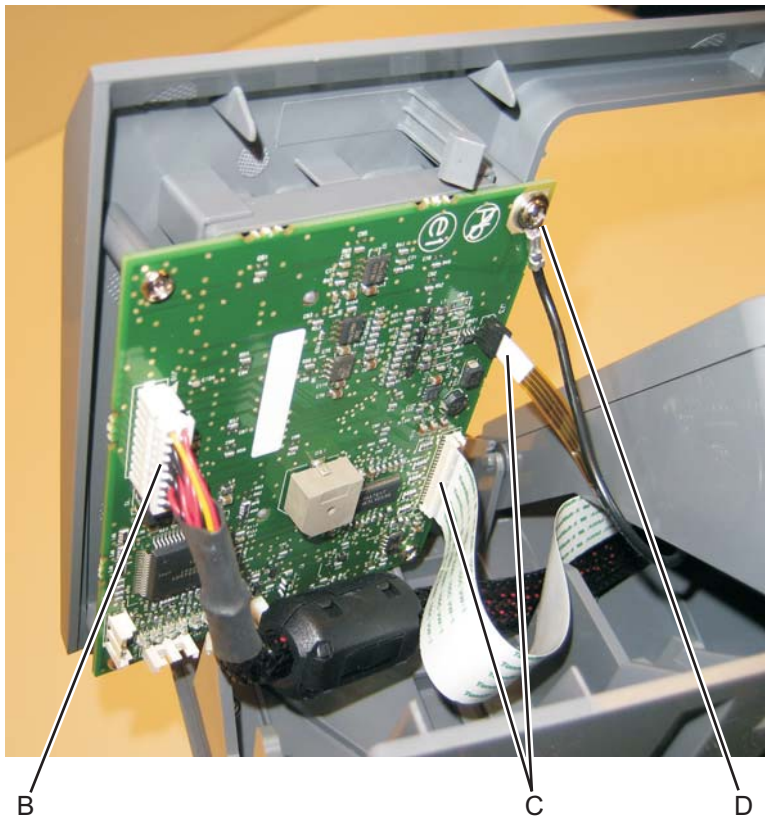

6. Tilt the operator panel keypad up and remove it from the MFP.

Operator panel display removal

1. Remove the operator panel keypad.
2. Press the tab on the left side of the operator panel display and raise the operator panel display to the up position.
3. Press the tabs (A) which fasten the operator panel display to the display rotation supports to the left to release the operator panel display from the display rotation supports.

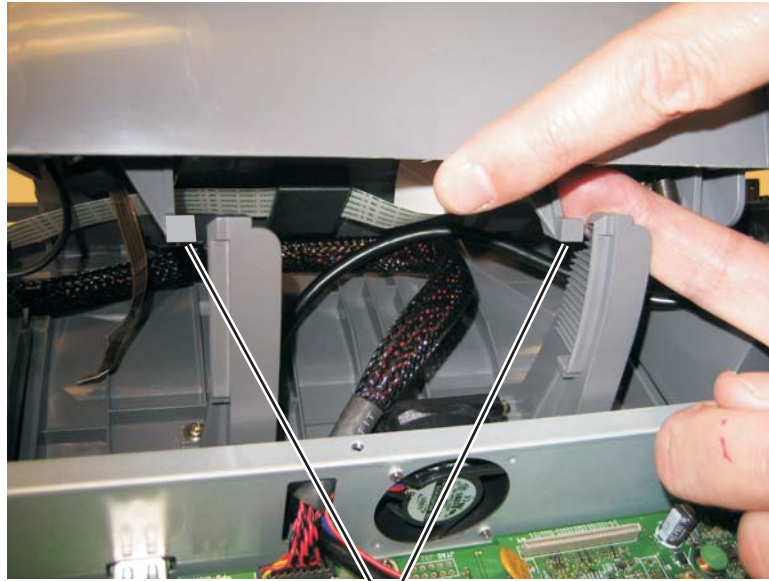

A

4. Disengage the operator panel display from the right display support and remove it from the MFP.



Display bezel

1. Remove the operator panel display. See **“Operator panel display removal” on page 4-65.**
2. Depress the two tabs (A) securing the display bezel to the operator panel display.

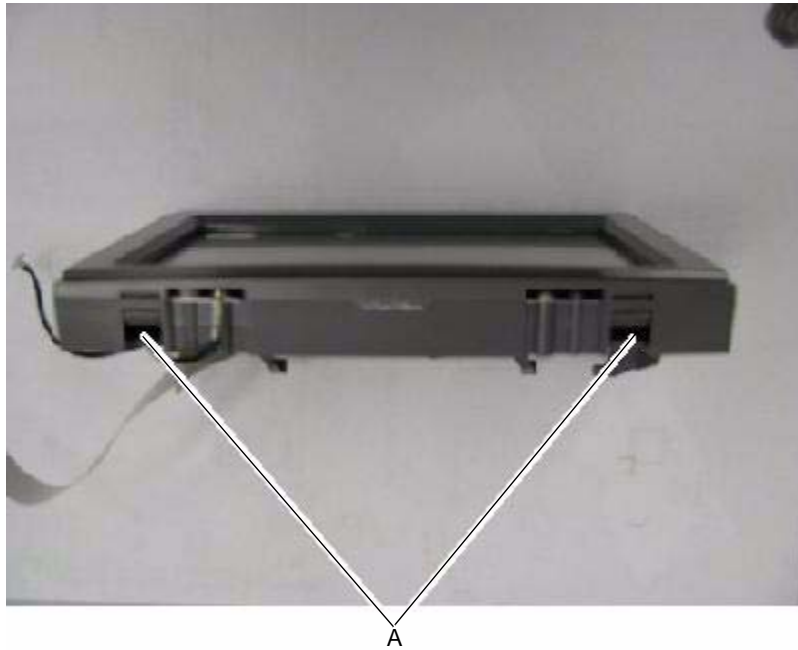

3. Pull the bezel away from the display.

UICC cable removal

1. Lift the scanner assembly to the up position.
2. Disconnect the UICC cable from the controller board.
3. Feed the cable through the hole in the front of the controller card cage.
4. Release the two tabs (A) securing the keypad to the keypad to the tub assembly.

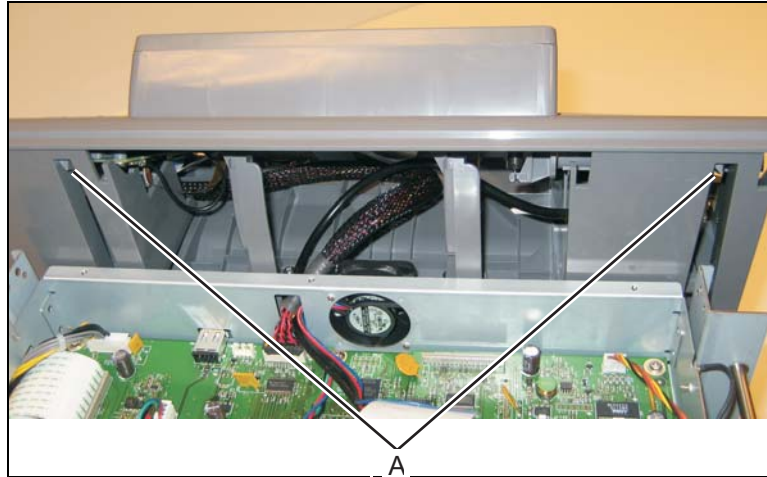

5. Disconnect the UICC cable B) from the operator panel PCB assembly.



USB cable mount bracket removal

1. Remove the operator panel keypad.
2. Open the USB cable clamp and remove the USB cable.
3. Remove the screw (A) securing the USB cable mount bracket to the tub assembly.

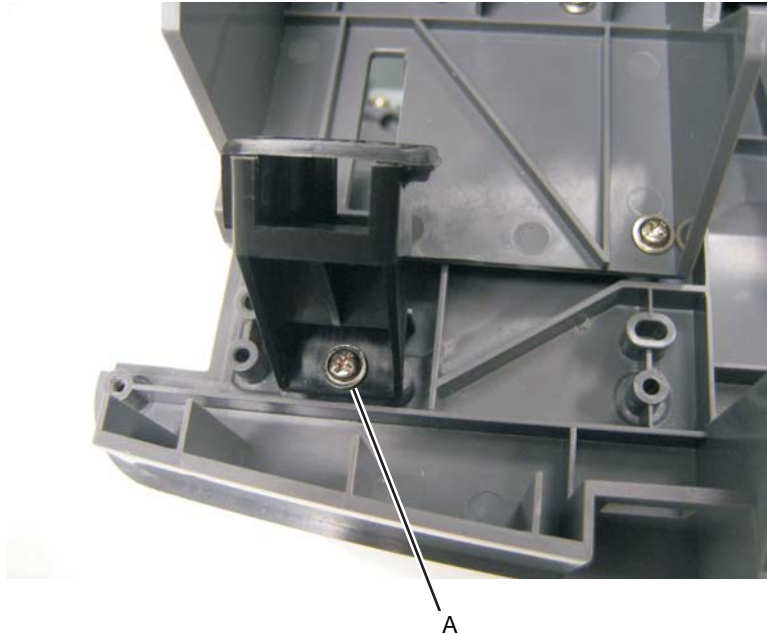

Operator panel support removal

1. Remove the operator panel keypad.
2. Remove the three screws (A) securing the operator panel support to the tub assembly.

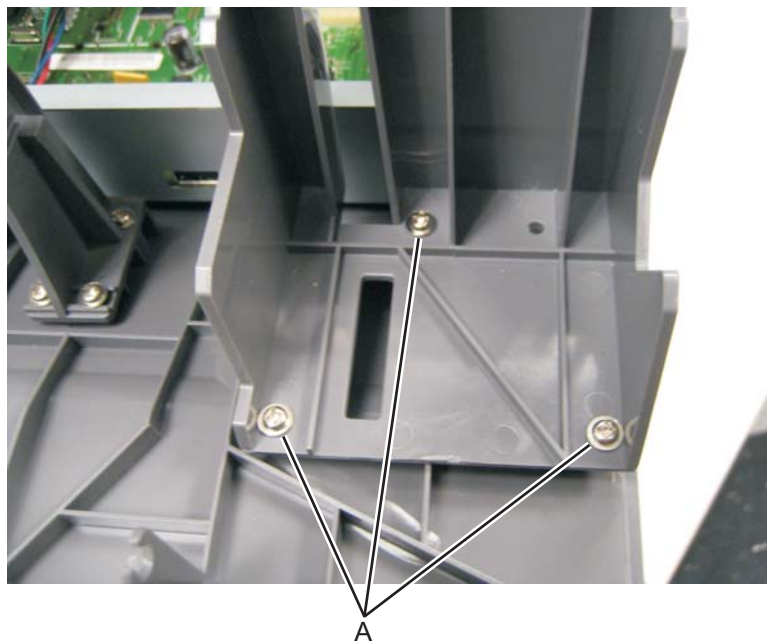

Note: The same steps are performed for both supports.

Display rotation support removal

1. Remove the operator panel display. See **“Operator panel display removal” on page 4-65.**
2. Remove the three screws (A)securing the display rotation support to the tub assembly.

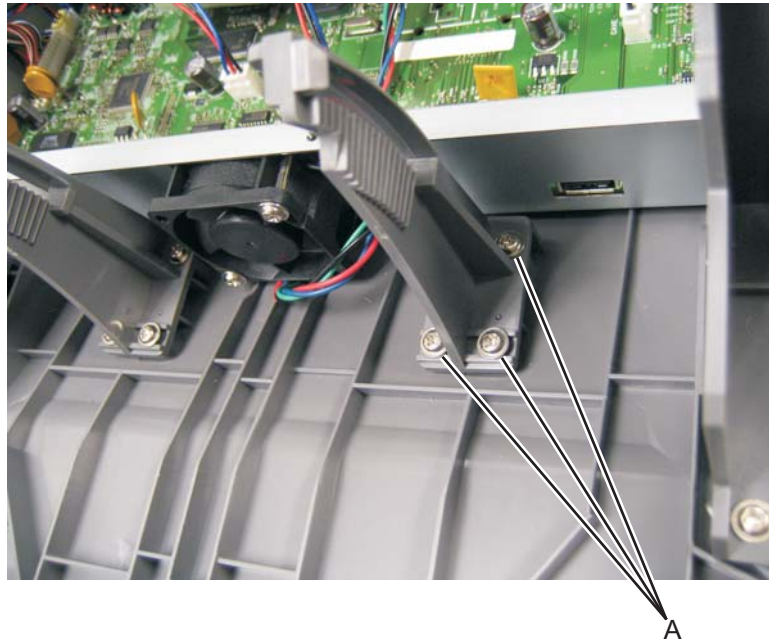

Note: The same steps are performed for both supports.

Left rear frame assembly removal

1. Remove the flatbed assembly. See **“Flatbed removal”** on page 4-89.
2. Remove the three screws (A) from the left rear frame assembly.

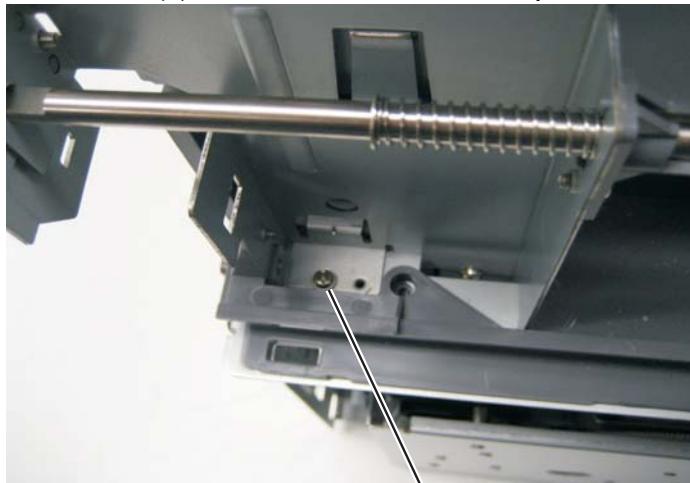

A

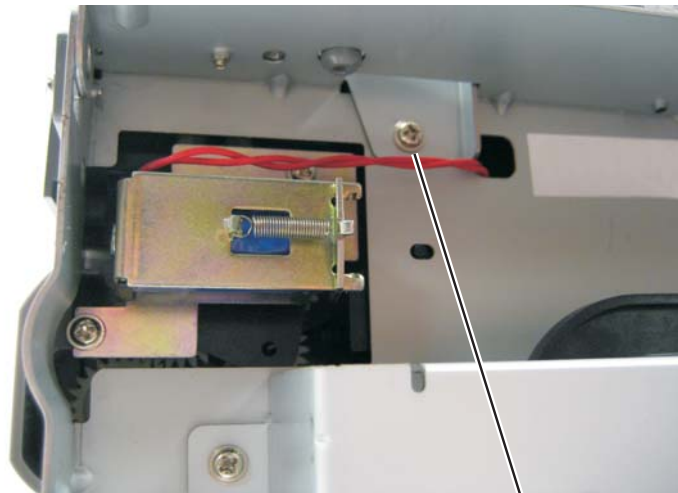

A



A

3. Carefully lift the left rear frame assembly off of the print engine frame.

Right rear frame assembly removal

1. Remove the flatbed assembly. See **“Flatbed removal”** on page 4-89.
2. Remove the three screws (A) from the right rear frame assembly.

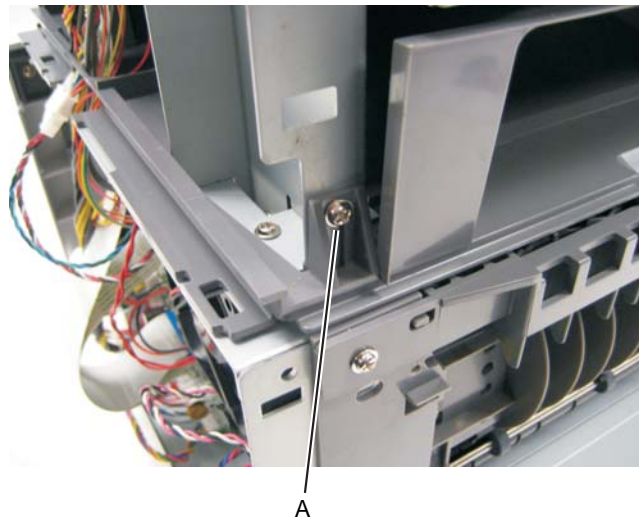
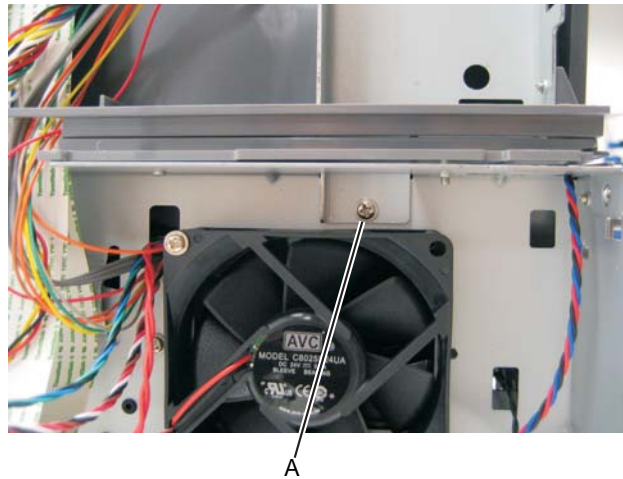
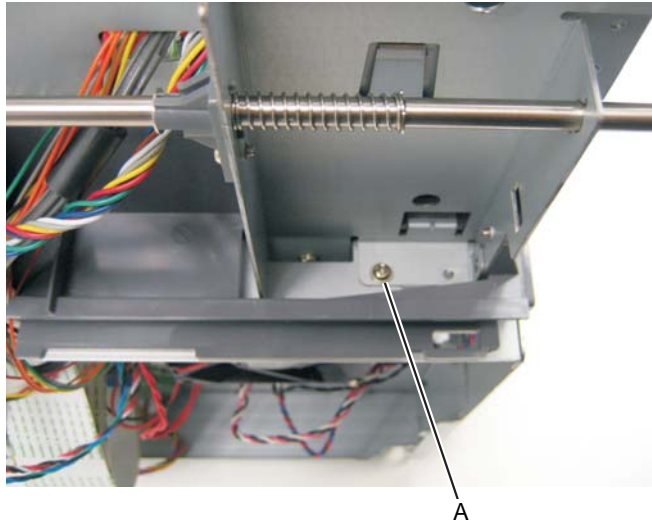

3. Carefully lift the right rear frame assembly off of the print engine frame.

Tub assembly removal

1. Remove the flatbed assembly. See **“Flatbed removal” on page 4-89.**
2. Disconnect the the remaining cables from the controller board.
3. Thread the cables through the tub assembly and top cover.
4. Remove the controller board cage. See **“Controller board cage” on page 4-14.**
5. Remove the operator panel keyboard. See **“Operator panel keypad removal” on page 4-64.**
6. Remove the operator panel display. See **“Operator panel display removal” on page 4-65.**
7. Remove the left rear frame assembly. See **“Left rear frame assembly removal” on page 4-70.**
8. Remove the right rear frame assembly. See **“Right rear frame assembly removal” on page 4-71.**
9. Remove the USB cable mount bracket. See **“USB cable mount bracket removal” on page 4-68.**
10. Remove the operator panel support. See **“Operator panel support removal” on page 4-68.**
11. Remove the operator panel display rotation support. See **“Display rotation support removal” on page 4-69.**
12. Remove the top and side screws securing the left flatbed support.
13. Remove the left flatbed support.
14. Remove the top and side screws securing the right flatbed support.
15. Remove the right flatbed support.
16. Lift the tub assembly off of the MFP.

Note: After removing the tub assembly, remove the output binLED and LED cover. See **“Output bin LED and lens removal” on page 4-101.** These will be used on the new tub assembly.

Paper input and duplex sensor assembly removal

1. Remove the right side cover. See **“Right side cover removal”** on page 4-80.
2. Remove the duplex. See **“Duplex removal”** on page 4-19.
3. Remove the two screws (A) from the sensors.

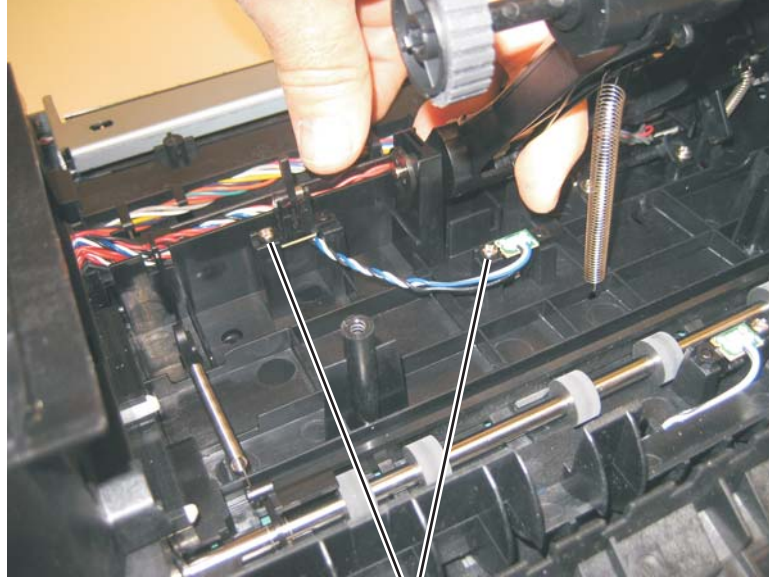

4. Disconnect the sensor cable (B) from the controller board.

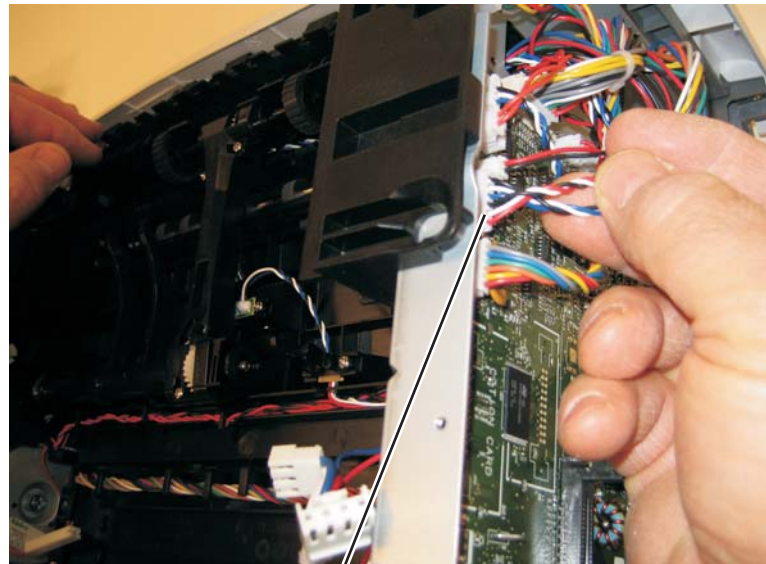

5. Remove the paper input and duplex sensor assembly.

Printhead removal

1. Remove the scanner assembly. See **“Scanner assembly removal”** on page 4-91.
2. Remove the top cover. See **“Top cover assembly removal”** on page 4-83.
3. Remove the right side cover. See **“Right side cover removal”** on page 4-80.
4. Disconnect the LSU cable. Use this cable with the new printhead.

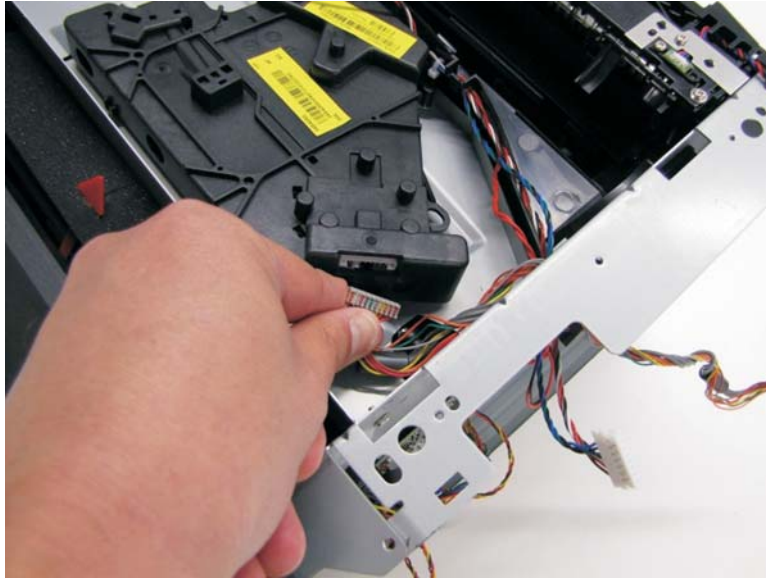

5. Disconnect the HSYNC cable. Use this cable with the new printhead.

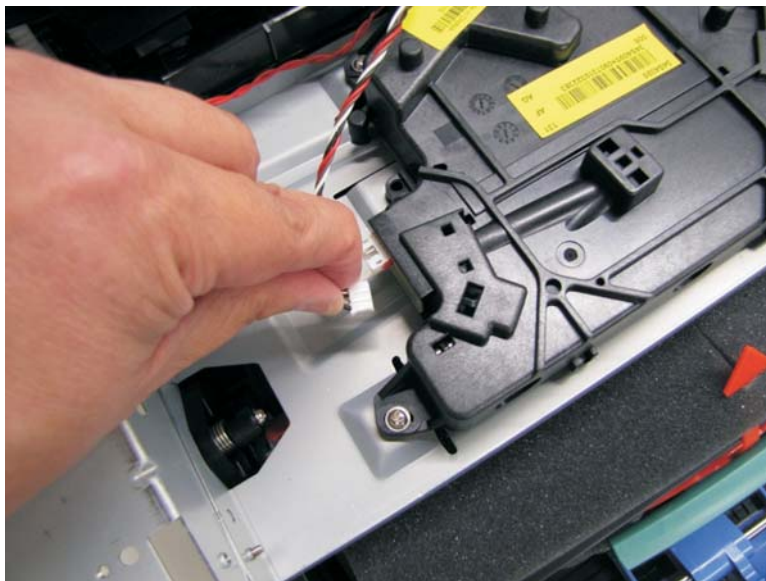

6. Remove the three screws (A).

Note: Use a pencil to mark the screw locations of the printhead on the metal frame. Align the new printhead relative to the location of the old printhead. See **“Printhead assembly mechanical adjustment”** on page 3-39.

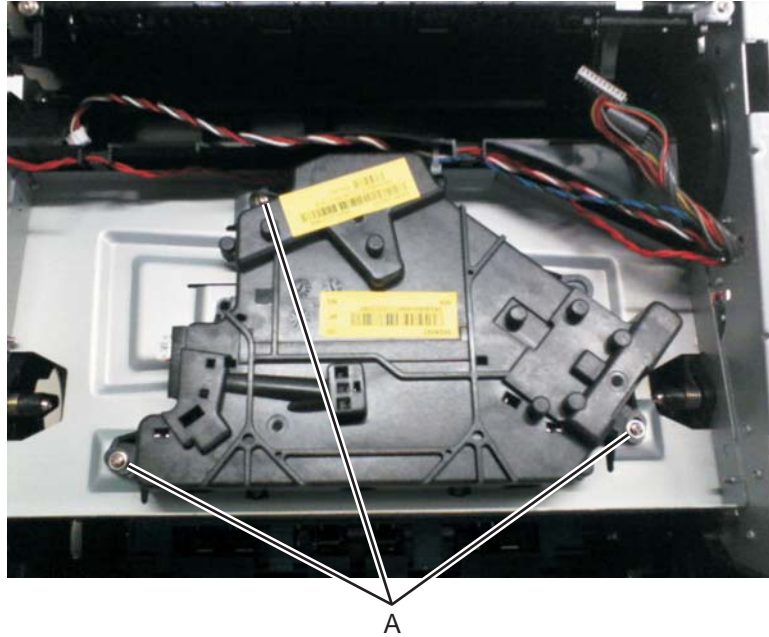

7. Remove the printhead.

Note: If the problem is caused by faulty cables, order cable parts 40X5816 and 40X5817.

Mid rear cover removal

1. Remove the two metal screws (A).

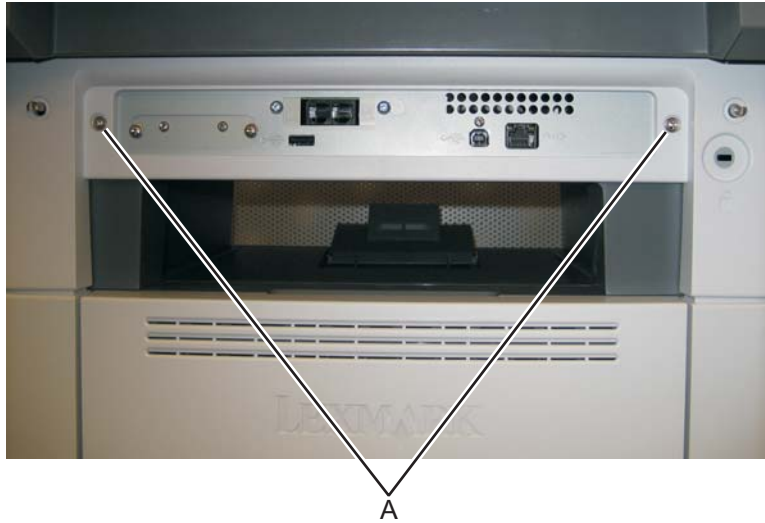

2. Pull the upper rear cover back.
3. Carefully disengage that snaps and remove the cover.



Rear door and lower rear cover removal

1. Remove the mid rear cover. See **“Mid rear cover removal”** on page 4-76.
2. Open the rear door.
3. Pull the rear door up at an angle, disconnect the door from the notch (A), and remove.

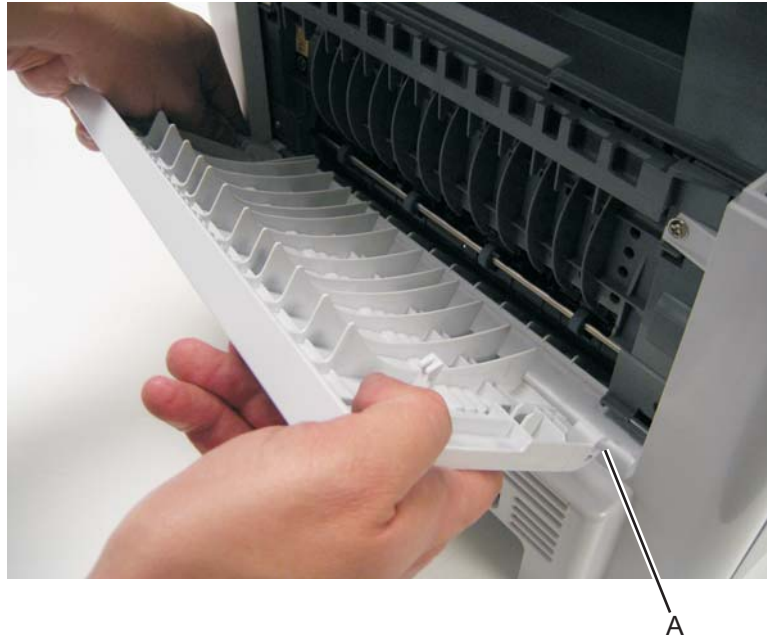

4. Remove the two screws (B) from the top of the rear cover.

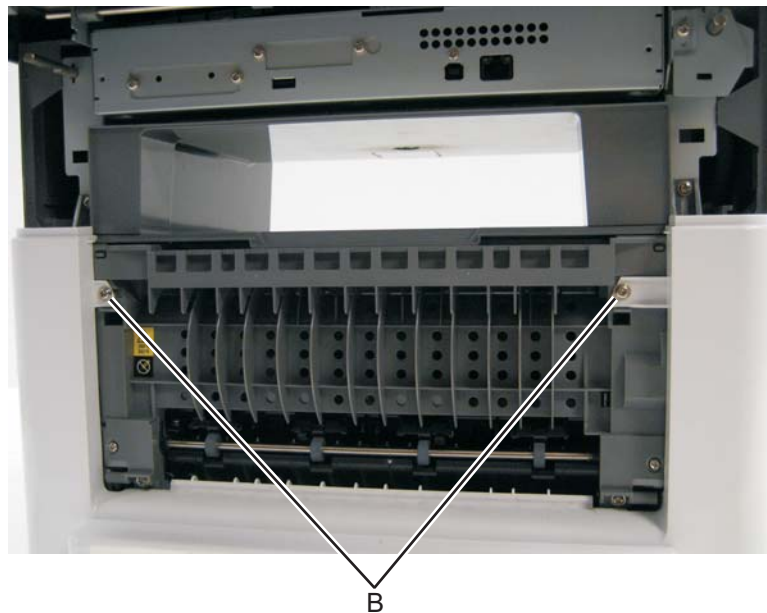

5. Tilt the lower rear cover, and remove.

Rear exit guide assembly with sensor and reversing solenoid removal

1. Remove the top cover. See **“Top cover assembly removal”** on page 4-83.
2. Disconnect the narrow media sensor cable from J35 on the engine board.
3. Remove the reversing solenoid cable from J10 on the engine board.
4. Remove the six screws (B) from the rear exit guide assembly.

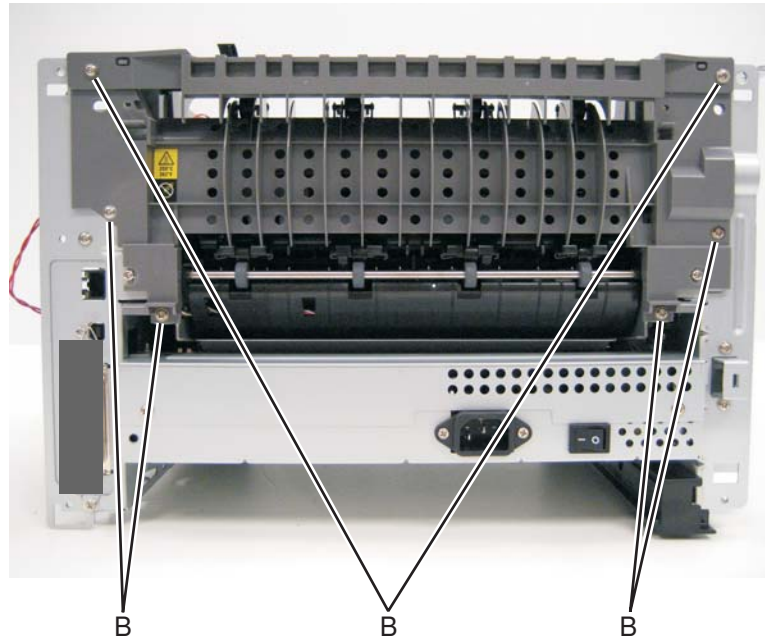

5. Remove the solenoid cable (C) through the opening.

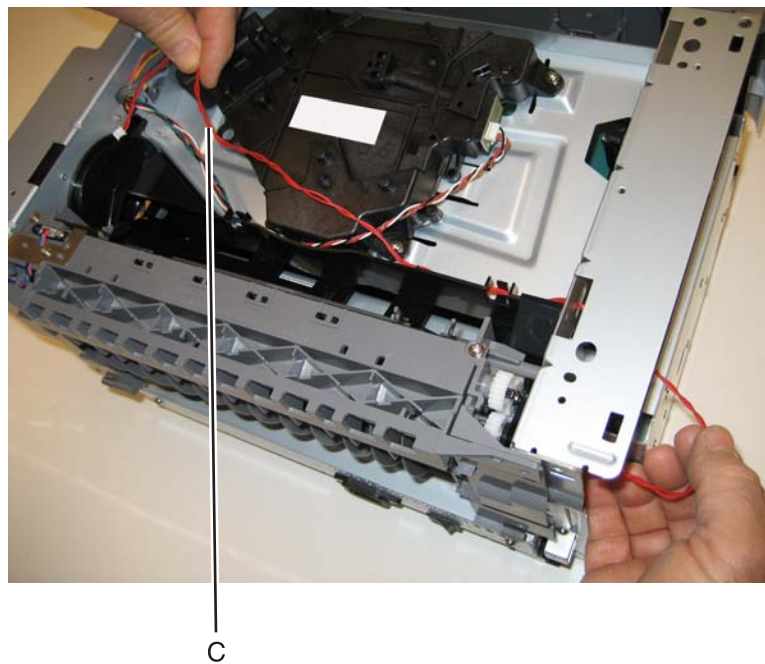

6. Remove the narrow media sensor cable (D) through the opening.

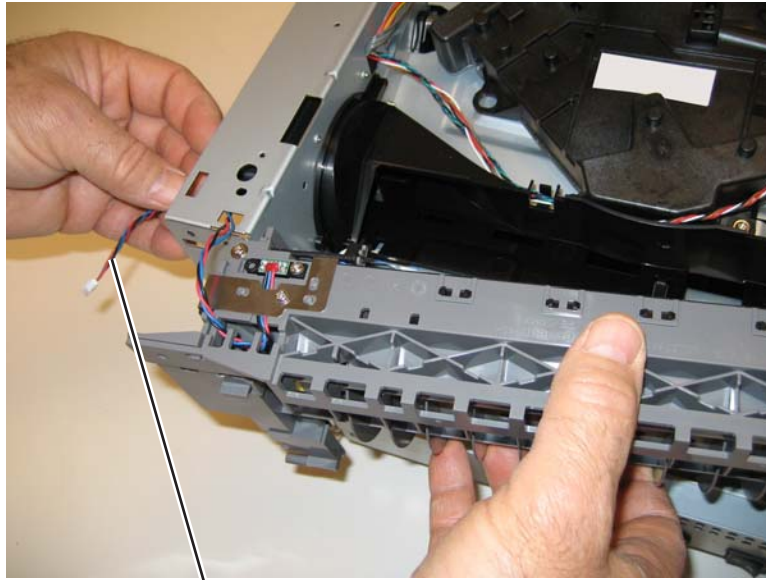

D

7. Remove the rear exit guide assembly.

Note: Be careful to not damage the gears during the rear exit guide assembly removal and reinstallation.

Right side cover removal

Note: Leave the front cover closed when removing the right side cover assembly.

1. Remove the scanner front cover. See **“Scanner front cover removal”** on page 4-31.
2. Remove the plastic screw (A) securing the cover to the tub assembly.



3. Remove the screw (B) from the bottom right side of the printer.

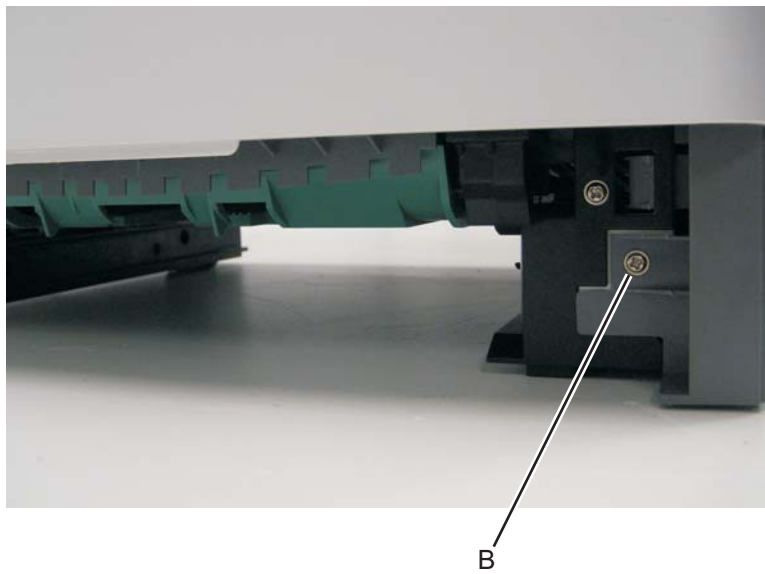

4. Depress the tab (C) on the bottom of the printer.

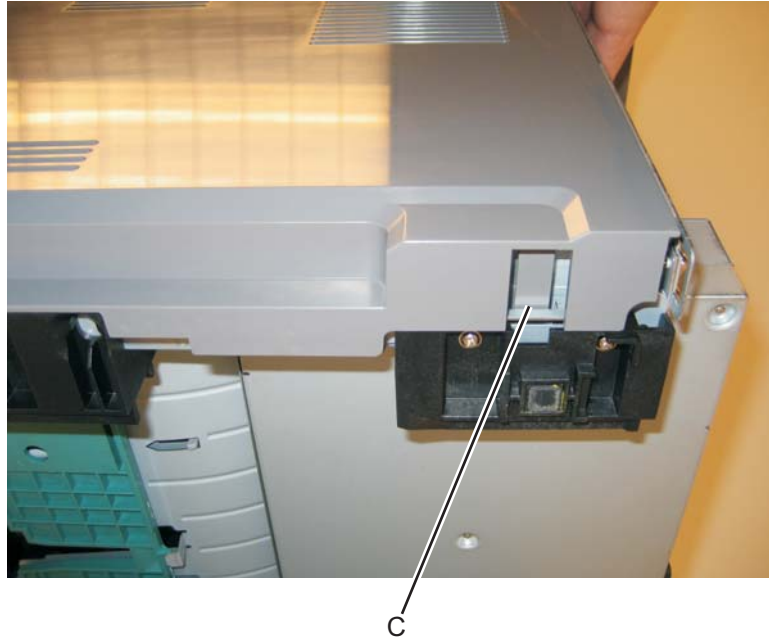

5. Rotate the right side cover assembly slightly to the left, and pull out.

Toner level sensor removal

1. Open the front access door.
2. Remove the right side cover. See **“Right side cover removal” on page 4-80.**
3. Disconnect the toner level sensor cable (A) from the engine board.

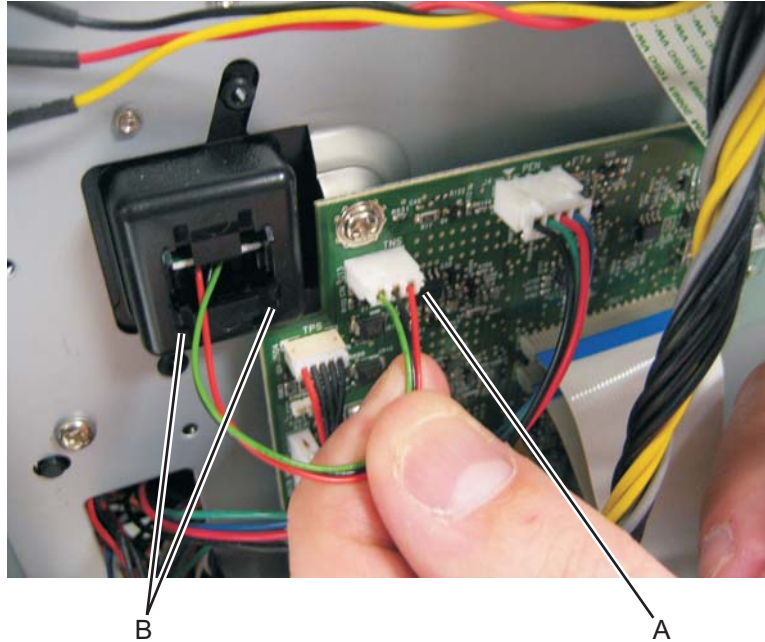

4. Squeeze the lower tabs (B) of the toner level sensor, and push it from its holder.
5. Remove the toner level sensor through the inside of the printer.

Note: The toner level sensor must be installed properly, or the printer will not function.

Top cover assembly removal

1. Remove the scanner assembly. See **“Scanner assembly removal”** on page 4-91.
2. Lift the top cover, and remove.

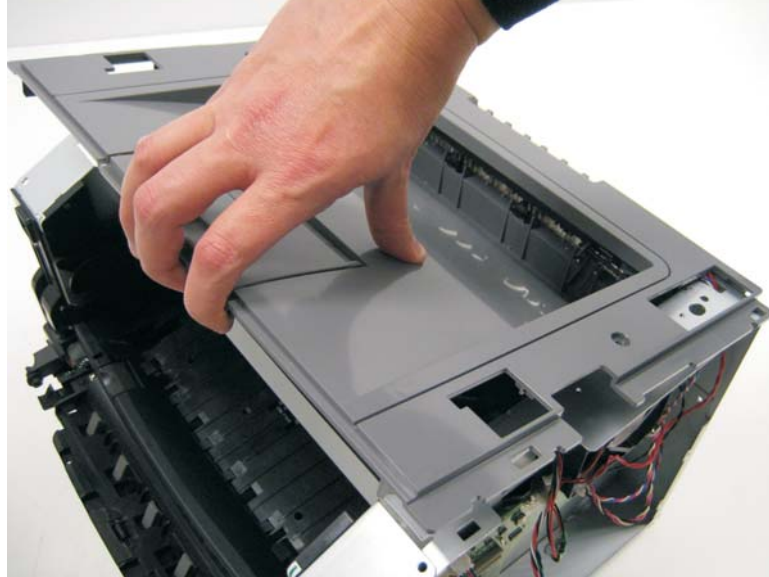

Note:

- Be sure to lift the top cover assembly from the front to remove.
- During reinstallation, be sure the exit guide and the paper bin align correctly. A mismatch can cause paper jams.

Transfer roll removal

Note: A flashlight may be required to remove the transfer roll.

1. Open the front access door.
2. At the right side of the transfer roll, squeeze the holder arms (A) with the left hand while lifting. Stop when the holder is unlatched.

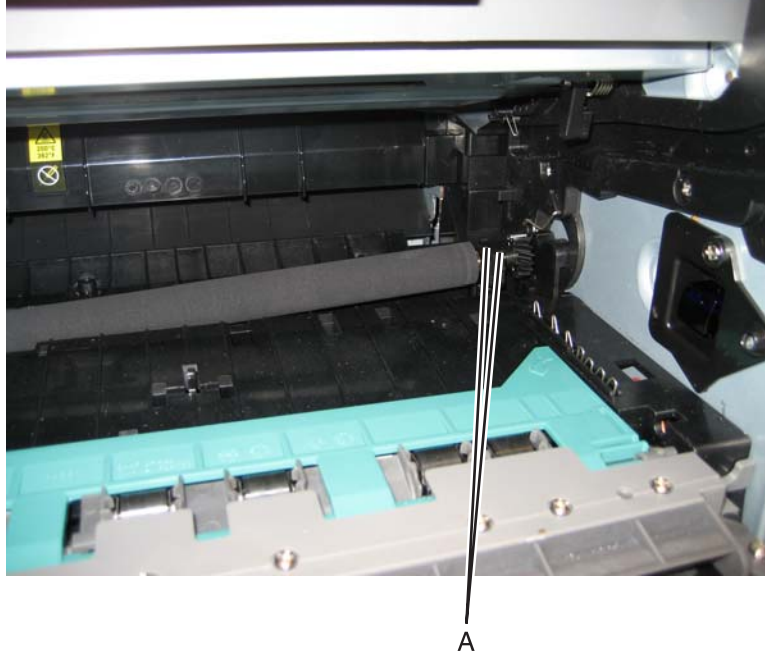

3. At the left side of the transfer roll, squeeze the holder arms with the right hand while lifting with the left hand. Stop when the left holder is unlatched.
4. With a hand at each end, lift the transfer roll out.

Note: Do not try removing the spring on the left; it is not removeable but can be dislodged. The spring included with the FRU is to be used only if the old right-side spring is damaged or lost. Both springs must be positioned on posts that cannot be seen. If the old springs are moved, then feel the base of the springs to assure that they are on the posts. The top of the springs must be captured in the bearings of the transfer roll.

Upper front guide assembly removal

1. Open the front access door.
2. Remove the four screws (A) from the upper front guide.

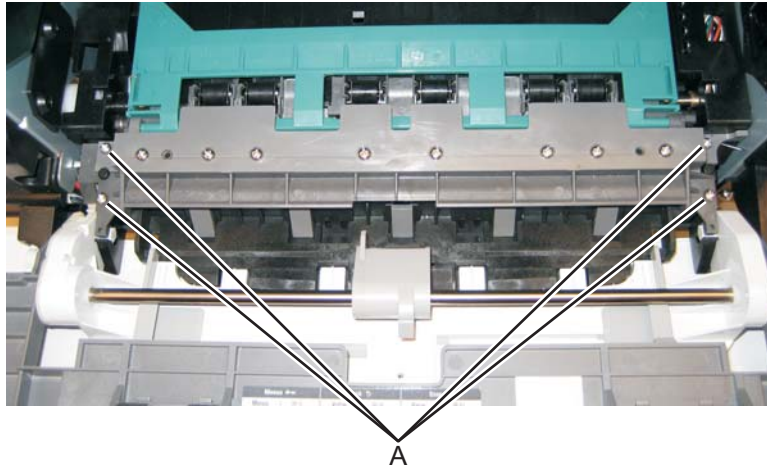

3. Remove the upper front guide.

Wear strip (tray 1 and 250-sheet tray 2) removal

1. Hold the tray with the bottom up.
2. Use a spring hook to disconnect the strip from the top of the tray.

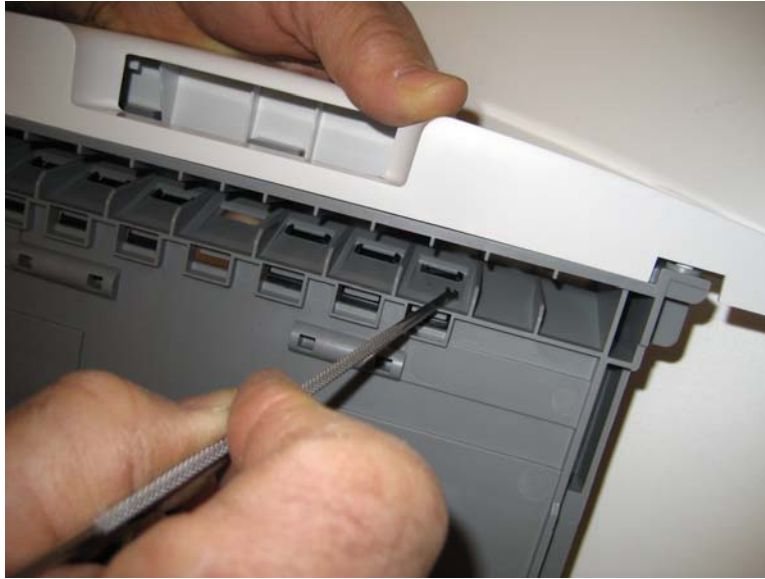

3. Remove the strip from inside the tray.



Wear strip (550-sheet tray 2) removal

1. Use a spring hook to disconnect the strip from the top of the tray.

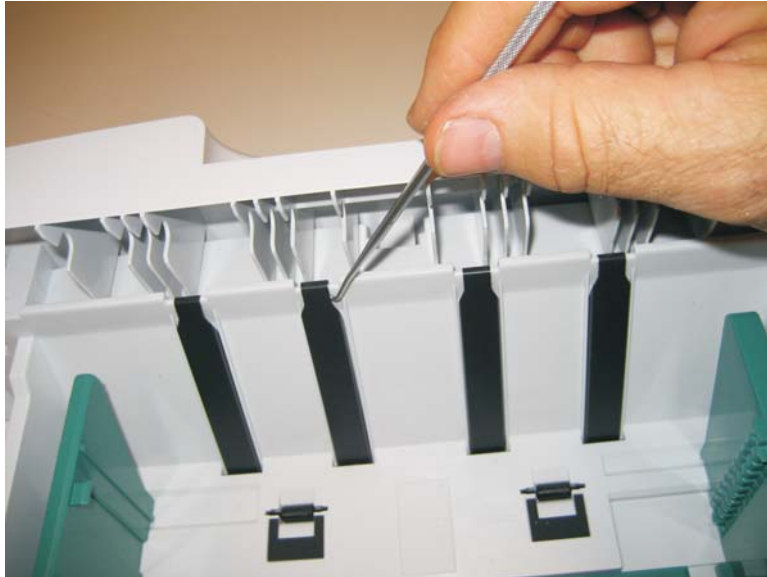

2. Lift the strip, and remove.

Note: When replacing the strip (for all trays):

- Carefully insert the strip from the top of the tray, and push it down through the opening until it snaps into place.

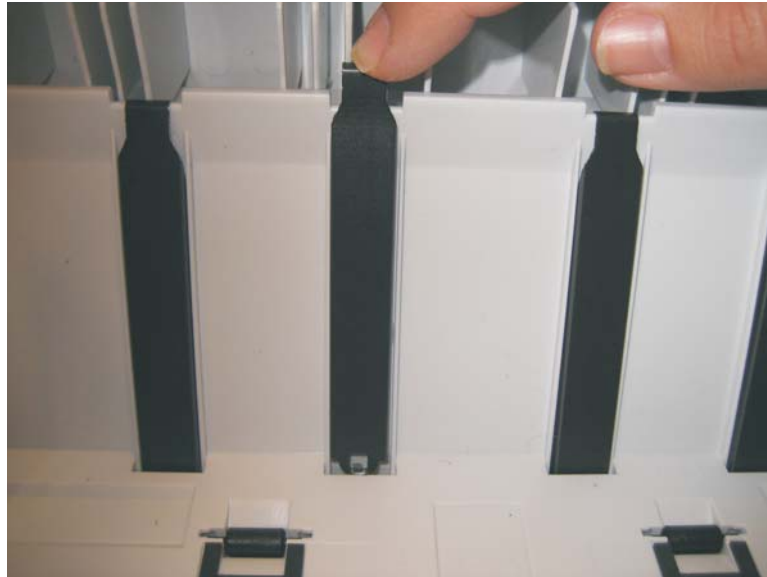

- Turn the tray over to view the bottom of the strip. Using the spring hook, check to make sure that the end of the strip is fastened tightly.
- Be sure that the drafted edge of the strip is installed toward the bottom of the tray.

Imaging component removals

ADF unit removal

1. Remove the ADF rear cover by releasing the three tabs (A) which fasten the ADF rear cover to the ADF unit.

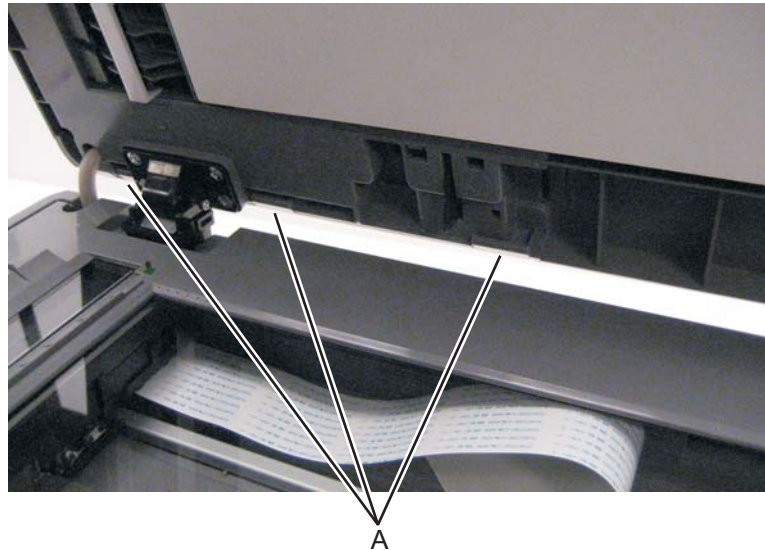

2. Disconnect the ADF cable (B) and two sensor connections (C) on the relay card above the ADF relay cable.

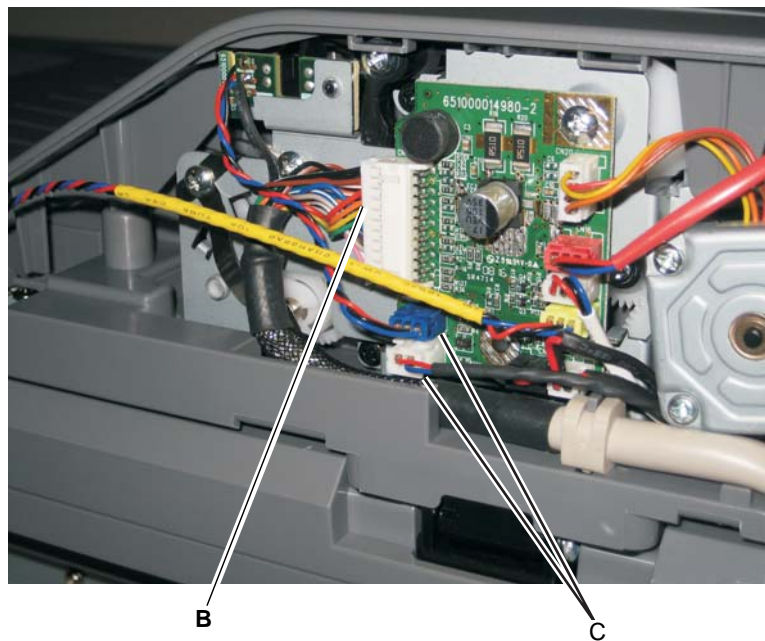

3. Lift the ADF unit up and depress the tabs located on the bottom of the ADF hinges to release the ADF from the flatbed.

Flatbed removal

1. Remove the left side cover. See **“Left side cover removal” on page 4-33.**
2. Remove the left scanner cover. See **“Left scanner cover removal” on page 4-103.**
3. Remove the right scanner cover. See **“Right scanner cover removal” on page 4-104.**
4. Remove the right side cover. See **“Right side cover removal” on page 4-80.**
5. Remove the ADF unit. See **“ADF unit removal” on page 4-88.**
6. Raise the flatbed unit to the up position.
7. Remove the controller board shield. See **“Controller board shield” on page 4-11.**
8. Disconnect FBmtr from connector J28, FB home from connector J13, CCD from connector J30, and Plegnth sensor cables from connector J12 on the controller board.
9. Using a flatbed screwdriver, depress the lower tab on the kickstand, and lift the kickstand out of the left rear frame assembly.

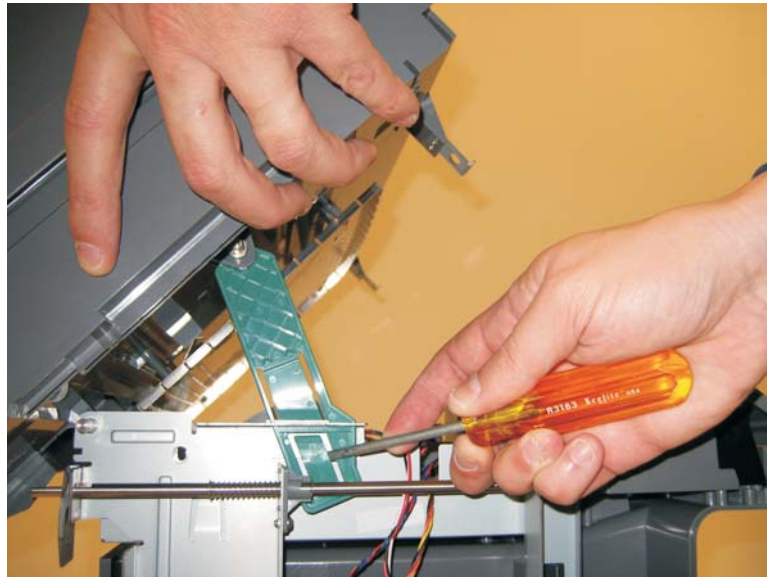

10. Remove the e-clip (A) from the flatbed hinge rod.

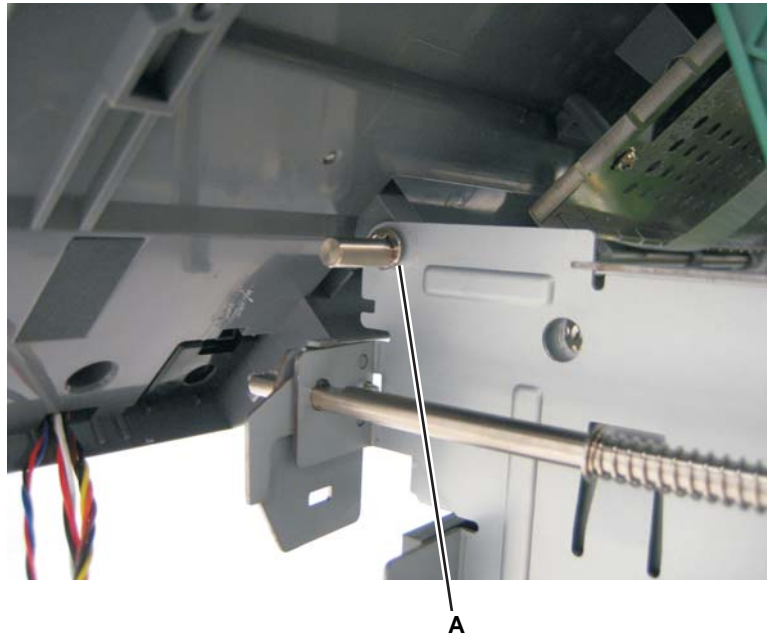

11. While holding the front of the flatbed with one hand, pull the flatbed hinge rod out.



12. Lift and remove the flatbed unit from the MFP.

13. Remove the kickstand (B).

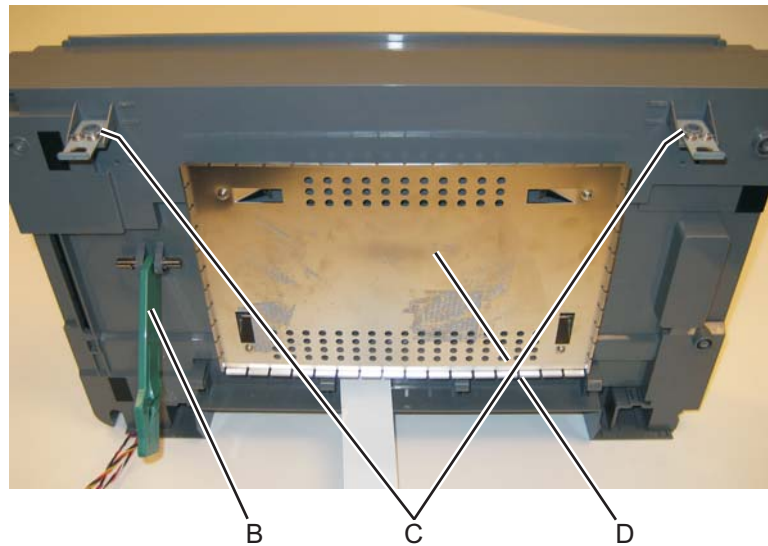

14. Remove the two flatbed supports (C). These will be used on the new flatbed.
 15. Remove the controller shield (D). This will be used on the new flatbed.

Scanner assembly removal

1. Remove the left scanner cover. See **“Left scanner cover removal”** on page 4-103.
2. Remove the right scanner cover. See **“Right scanner cover removal”** on page 4-104.
3. Remove the left side cover. See **“Left side cover removal”** on page 4-33.
4. Remove the right side cover. See **“Right side cover removal”** on page 4-80.
5. Lift the flatbed and ADF assemblies to the up position.
6. Remove the controller board shield. See **“Controller board shield”** on page 4-11.
7. Remove the toroid from the printhead cable and door interlock switch cable.

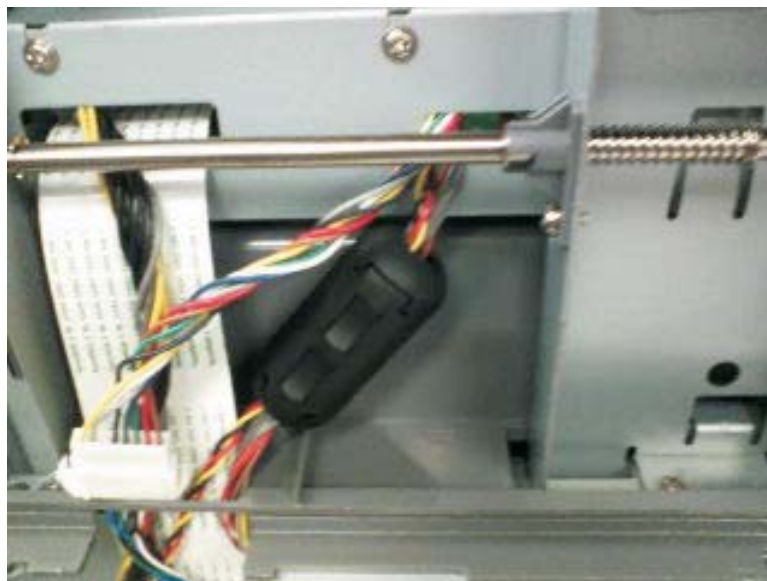

8. Disconnect the HVPS cable from connector J37 on the controller board.
9. Disconnect the front cover interlock switch cable from connector J11 on the controller board.
10. Disconnect the stairway cables from J500 and J501 on the engine board.

11. Disconnect the LSU laser diode cable from the controller board.

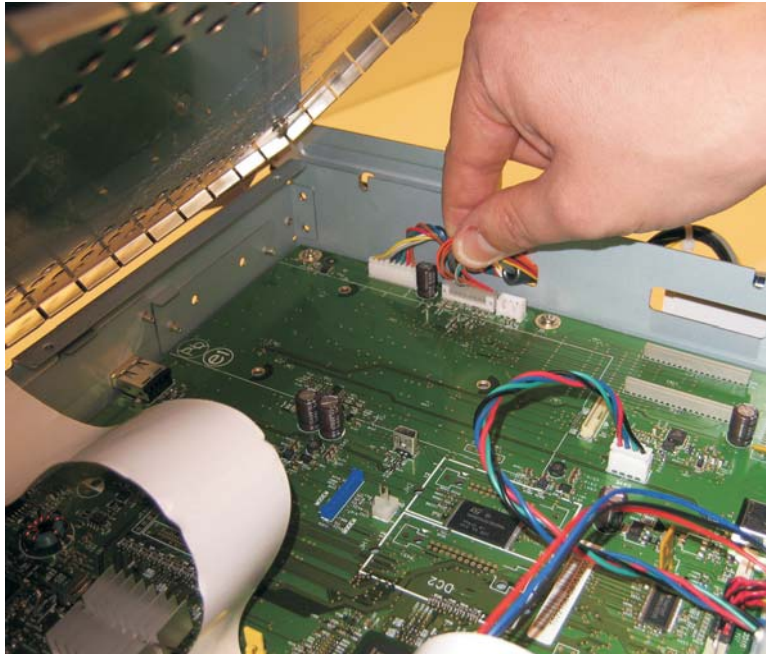

12. Thread the LSU diode cable, the cover interlock cable, the stairway cables, and the controller board power supply cable through the side of the printer away from the scanner assembly.

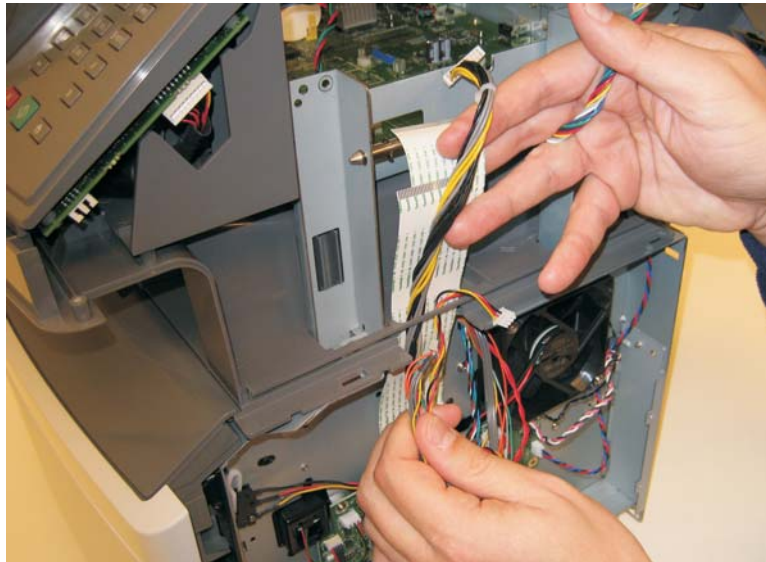

13. Disconnect LSU HSYNC extension cable at the connector in the middle of the cable.

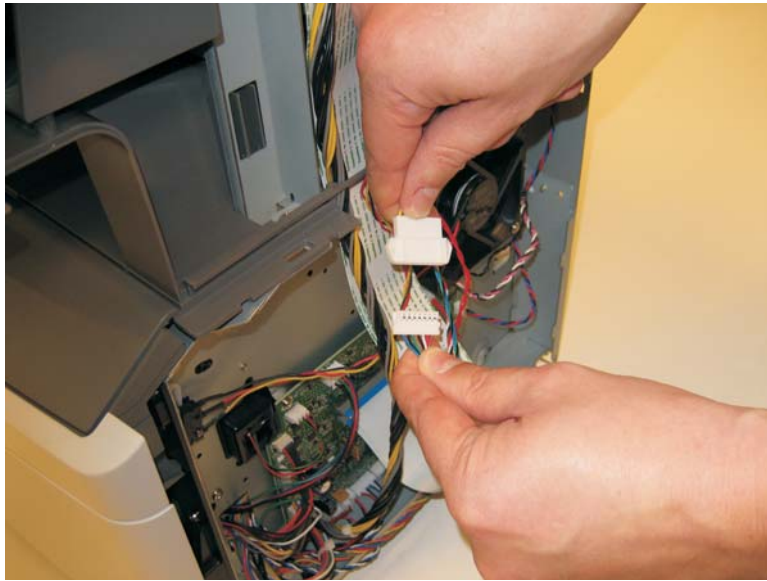

14. Remove the three screws (A) from the left rear frame assembly.

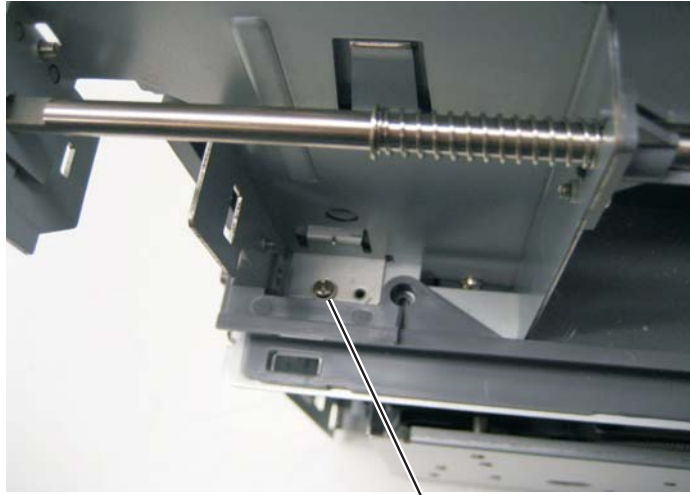

A

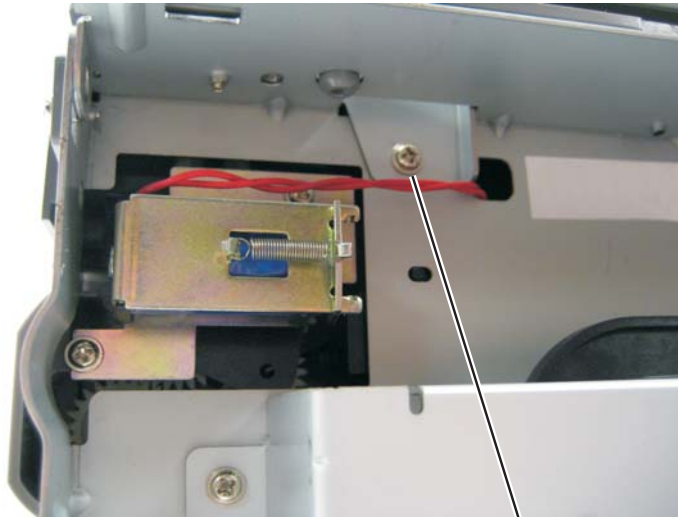

A



A

15. Remove the three screws (B) from the right rear frame assembly.

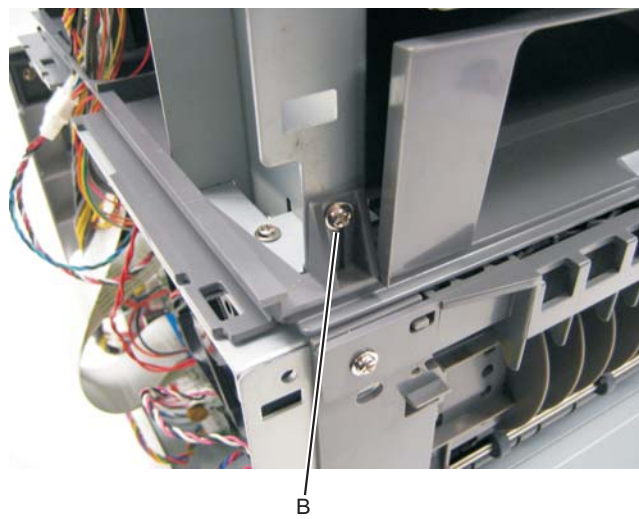
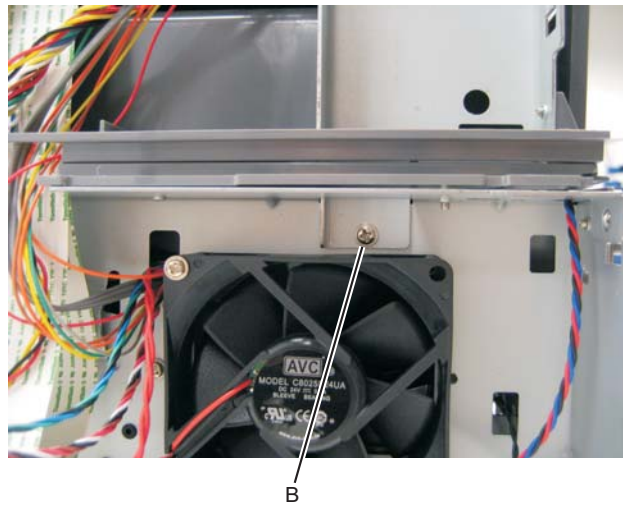
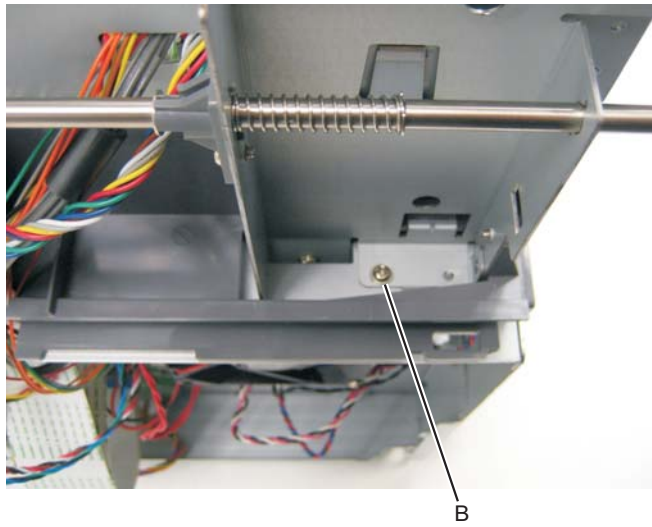

16. Remove the screw (C) securing the left flatbed stop to the top of the print engine frame.

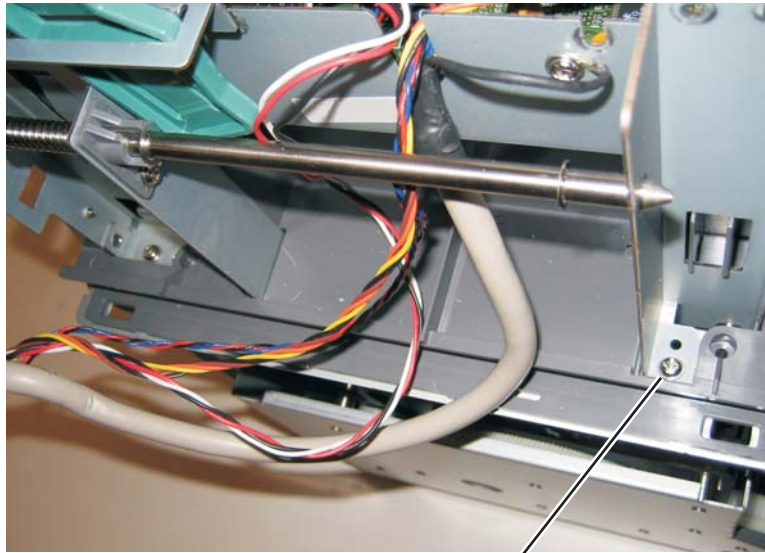

C

17. Remove the screw (D) securing the right flatbed stop to the top of the print engine frame.

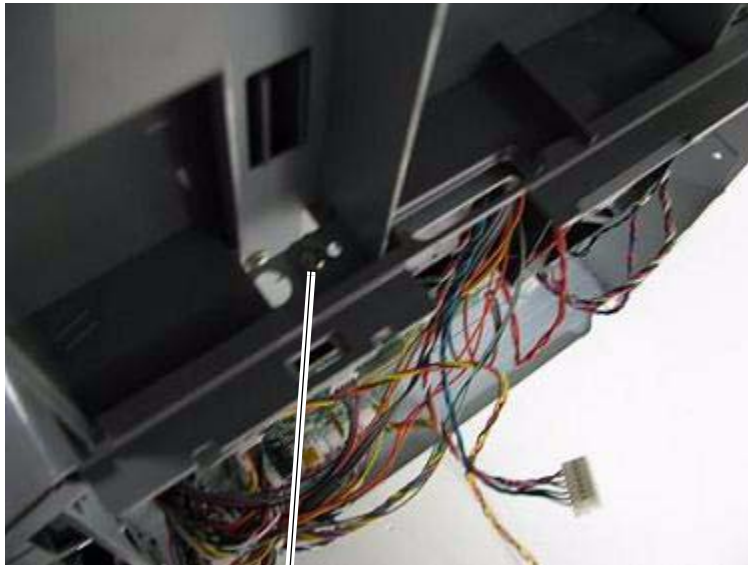

D

18. Lower the flatbed and ADF to the down position.

19. Remove the side screw (E) securing the left flatbed stop to the print engine frame.

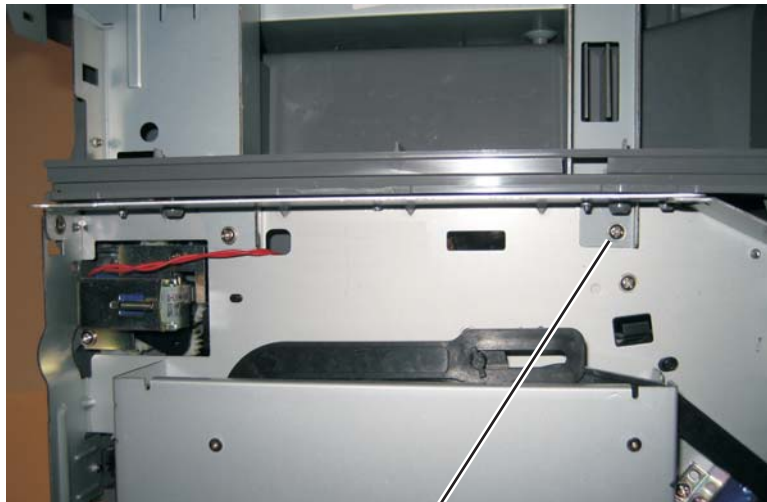

E

20. Remove the side screw (F) securing the right flatbed stop to the print engine frame.

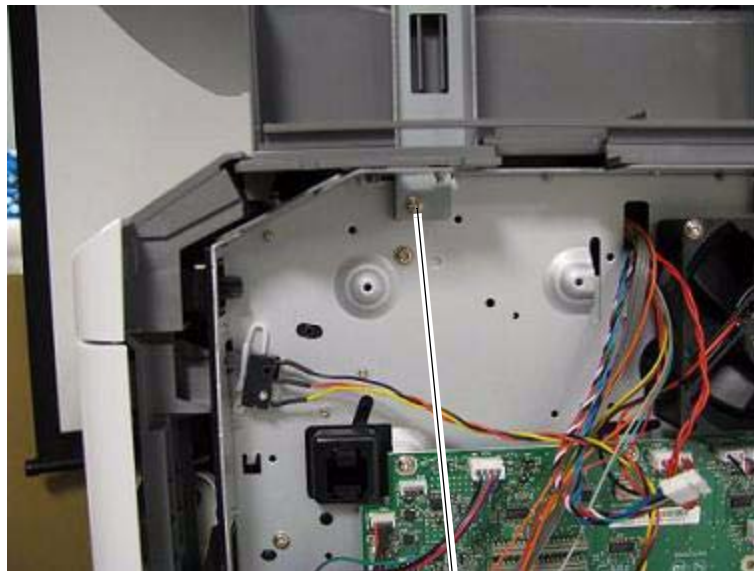

F

21. Lift and remove the scanner assembly from the MFP.

ADF separator pad

1. Remove the ADF separator roll. See **“ADF separator roll assembly”** on page 4-99.
2. Pinch the two tabs on each side of the pad inward.

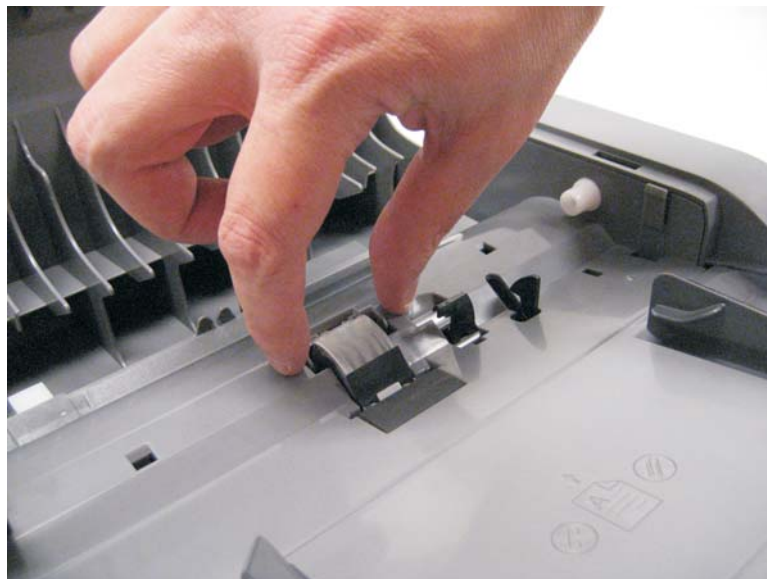

3. Tilt the pad up, and lift it out of the ADF assembly.

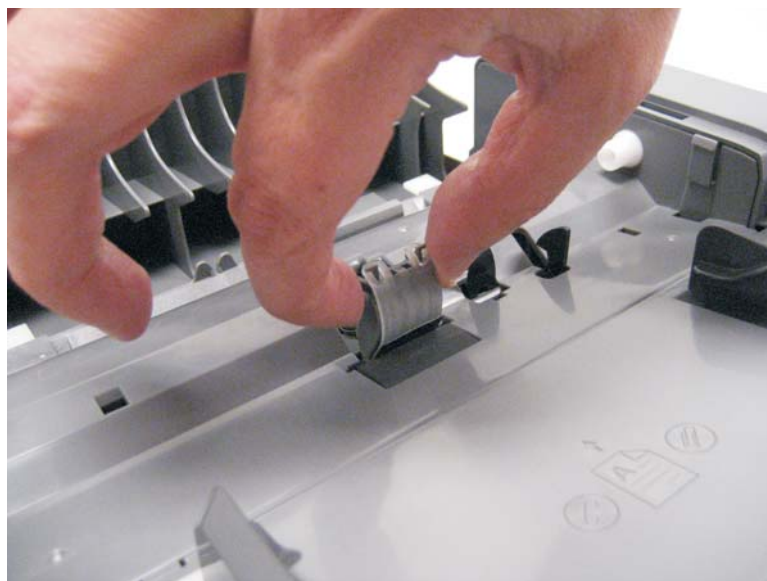

ADF separator roll assembly

1. Lift the locking lever (A).

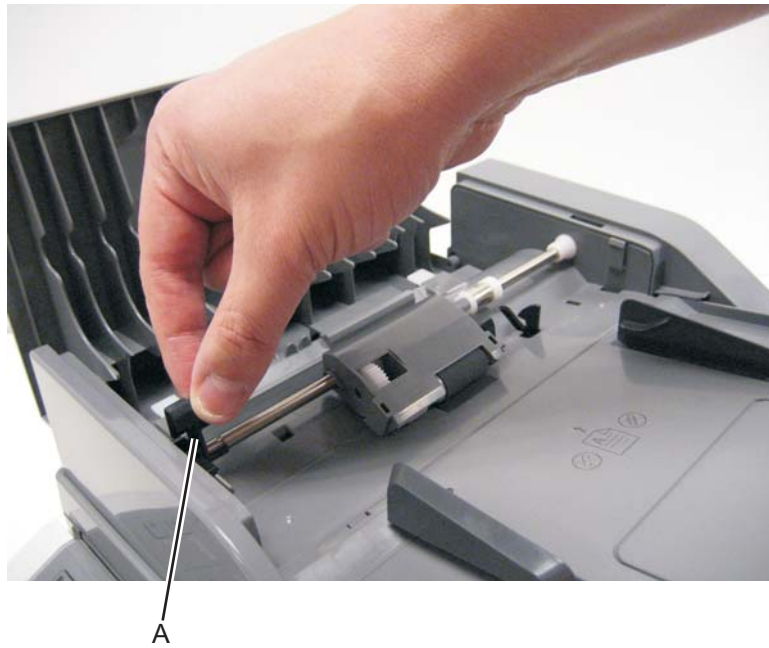

2. Slightly lift the separator roll assembly, and pull it out of the mount (B) on the opposite side.

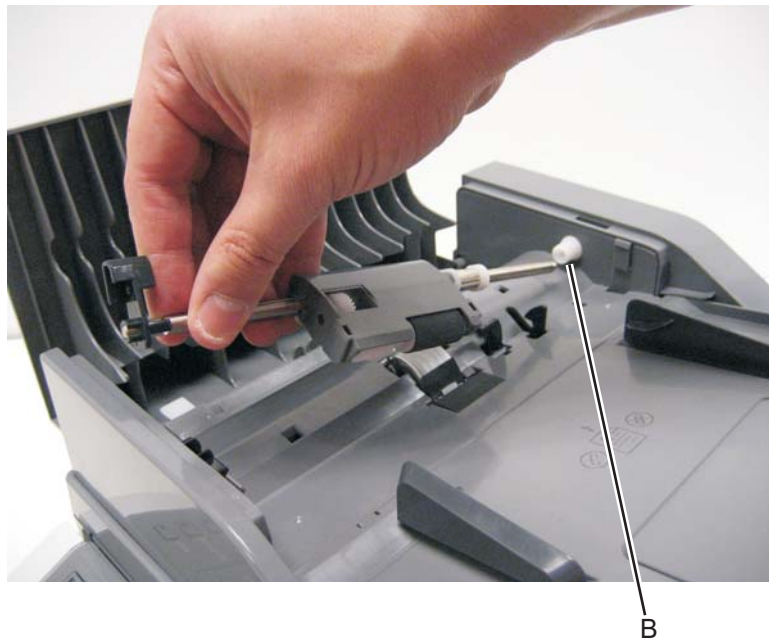

Kickstand removal

1. Lift the flatbed assembly to the up position.
2. Release the kickstand from the left rear frame assembly by depressing the tab holding the kickstand in place.

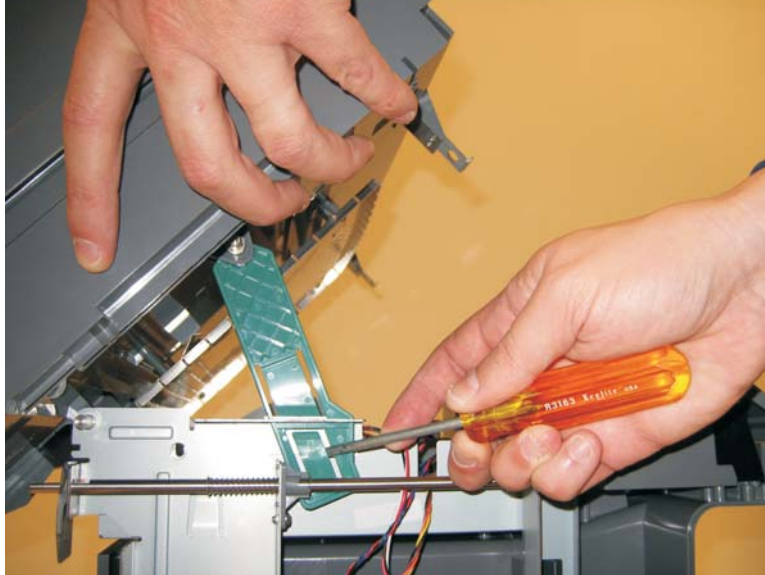

3. Remove the e-clip (A) securing the kickstand rod to the flatbed.



4. Slide the rod out and remove the kickstand from the flatbed.

Output bin LED and lens removal

1. Disconnect the output LED cable from the controller board.
2. Remove the controller board cage. See **“Controller board cage” on page 4-14.**
3. Press the tab (A) securing the lens to the tub assembly.

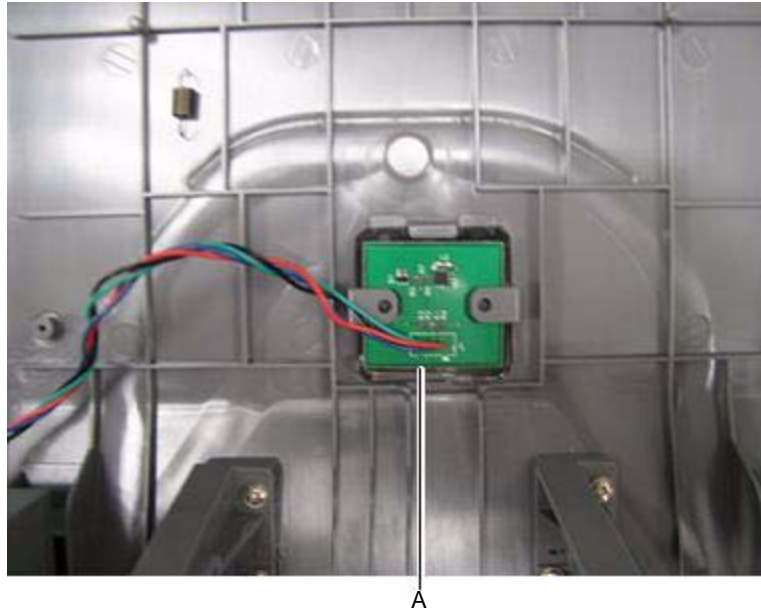

4. Pull down on the lens and LED and remove it from the tub.



ADF cable removal

1. Remove the left scanner cover. See **“Left scanner cover removal”** on page 4-103.
2. Remove the left cover. See **“Left side cover removal”** on page 4-33.
3. Remove the controller board shield. See **“Controller board shield”** on page 4-11.
4. Lift the flatbed cover and unsnap the three tabs (A) securing the ADF rear cover to the ADF.

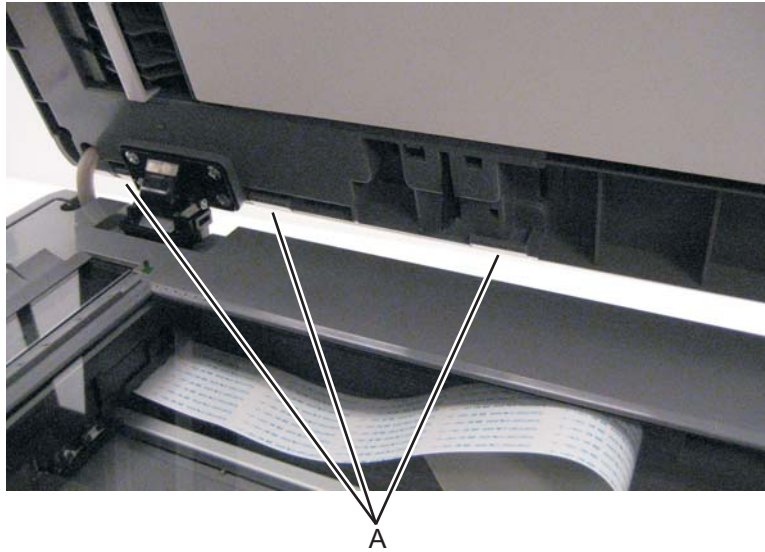

5. Remove the rear ADF cover.
6. Disconnect the ADF cable (B) and two sensor connections (C) on the relay card above the ADF relay cable.

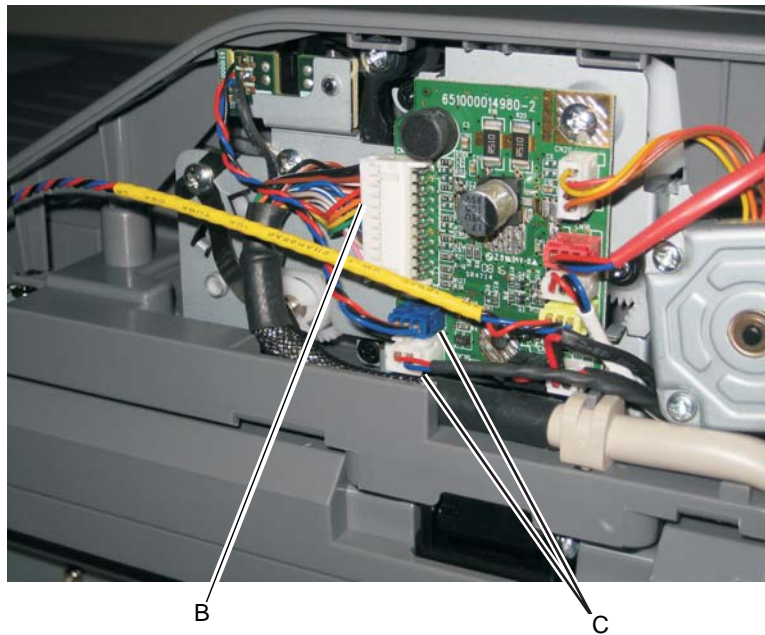

7. Disconnect the ADF cable from connector J17 on the controller board.
8. Disconnect the ADF cable ground from the controller cage.

9. Remove the ADF cable from the MFP.

Left scanner cover removal

1. Lift the ADF to the up position.
2. Remove the two screws (A) securing the left scanner cover to the flatbed unit.

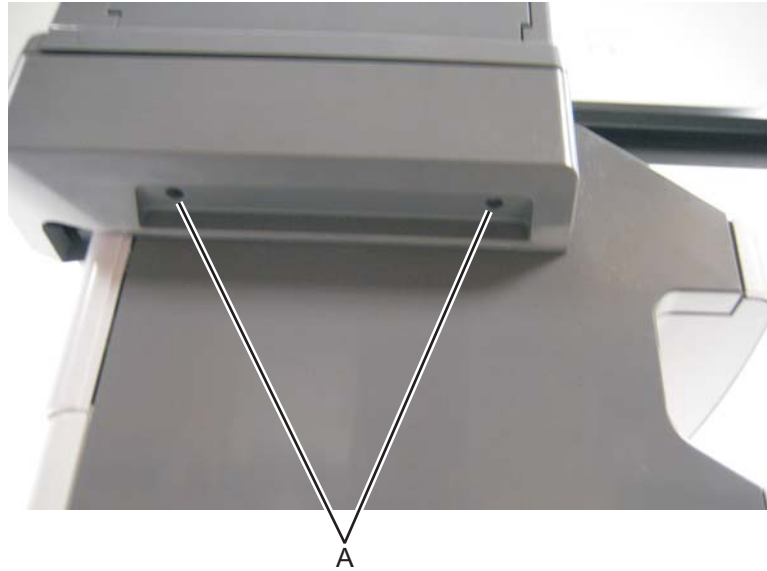

3. Lift and carefully pull the left scanner cover up and away from the rear of the flatbed.



Right scanner cover removal

1. Lift the ADF to the up position.
2. Remove the two screws (A) securing the right scanner cover to the flatbed unit.



A

3. Lift and carefully pull the right scanner cover up and away from the rear of the flatbed.

Option board installs and removals

Note: This information is also available in the X 46x series user guide.

Lifting the Scanner to the up position

1. Turn the two rear frame assembly locks counter-clockwise to the unlock position.

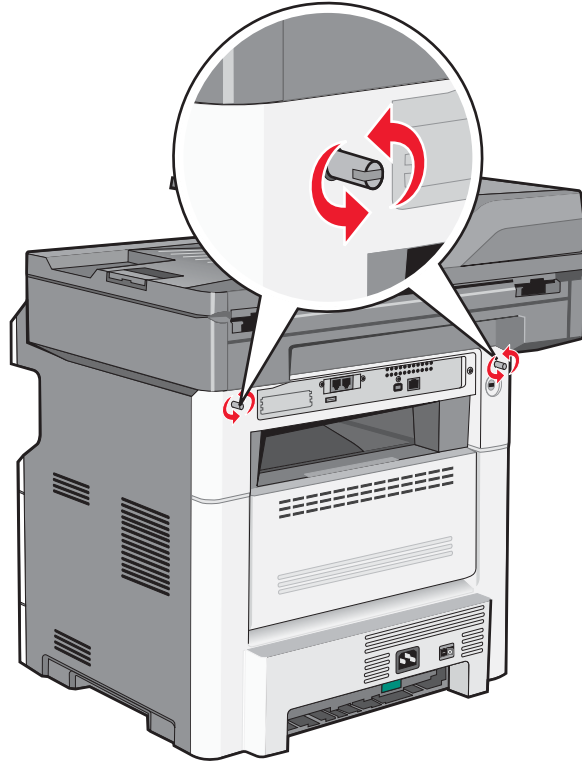

2. Lift the scanner assembly to the up position. The kickstand will lock into place.

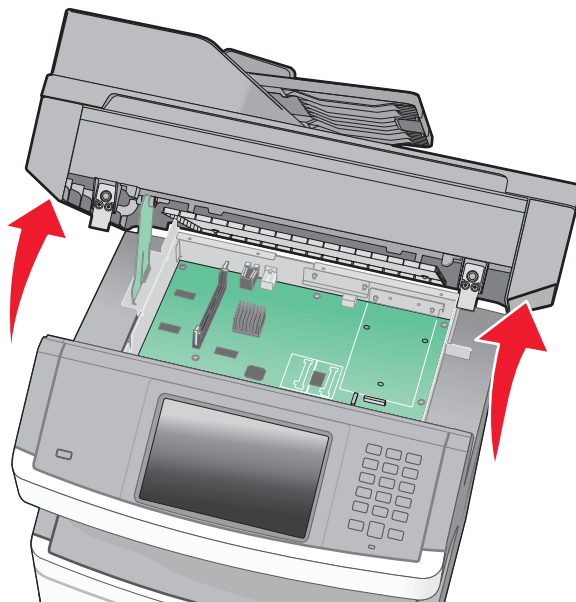

Installing an Internal Solutions Port (ISP)

1. Access the controller board. See **“Lifting the Scanner to the up position”** on page 4-105.
2. Unpack the ISP and tee.
Note: Avoid touching components on the card.
3. Locate the standoff location on the controller board.

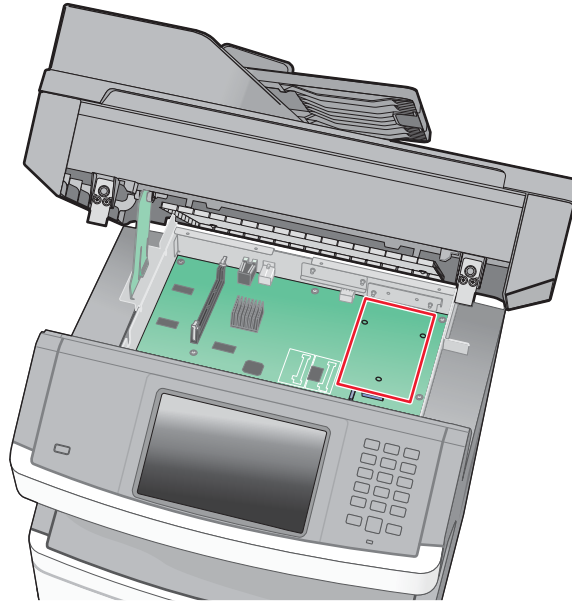

Note: If an optional printer hard disk is currently installed, then the printer hard disk must first be removed. See **“Printer hard disk removal”** on page 4-109.

4. Remove the metal cover from the ISP opening in the rear of the controller board cage.
5. Align the posts of the mounting tee, and press down to secure it to the controller board.

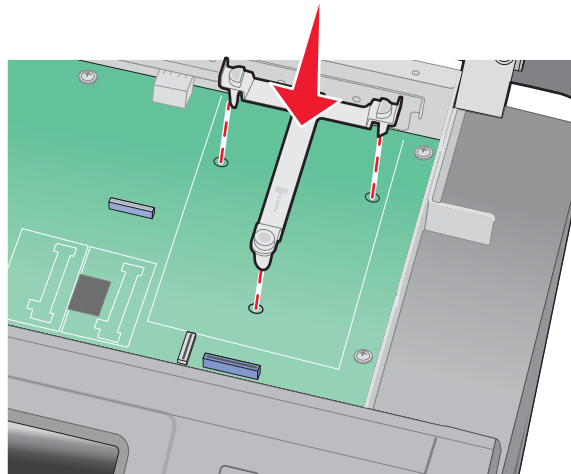

6. Install the ISP onto the plastic tee.

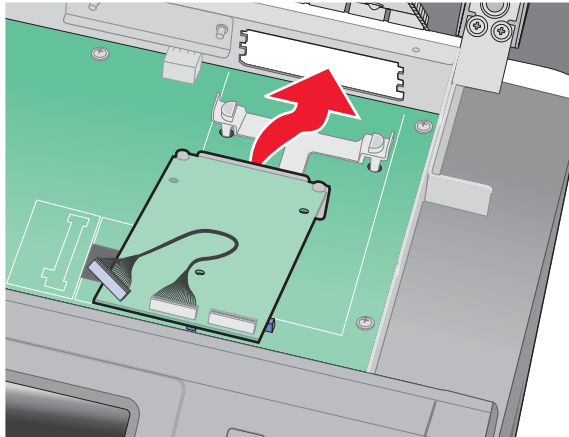

Note: Make sure the ISP card is properly aligned with the rear of the controller board cage.

7. Press down on the ISP to seat it in the tee.

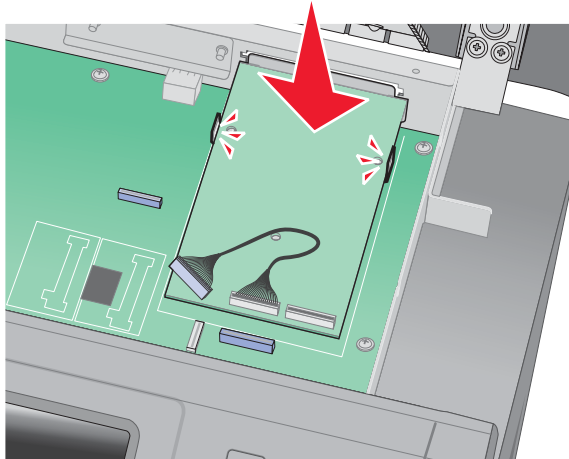

8. Insert the thumbscrew.

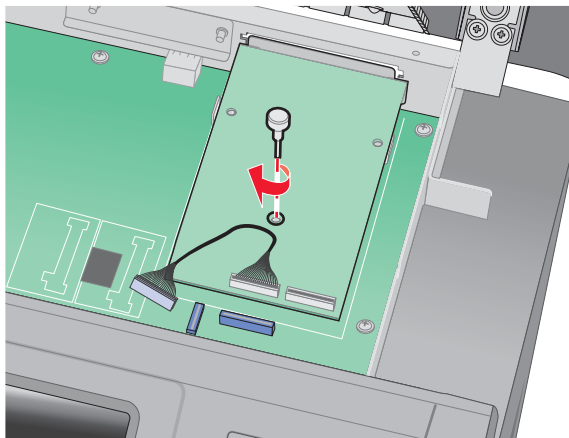

Note: Do not tighten the thumbscrew at this time.

9. Attach the two screws that came with the ISP to secure the ISP to the controller board cage.

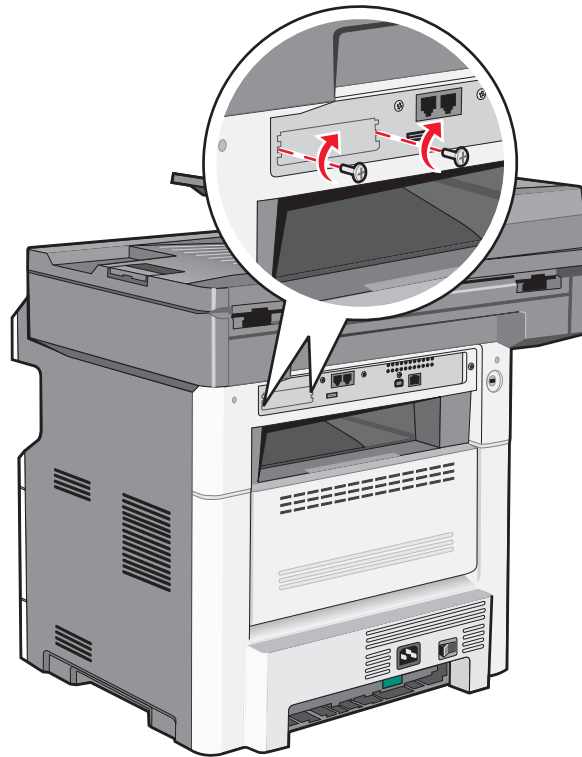

10. Tighten the thumbscrew from step 8.
11. Insert the cable's ISP connector into the ISP connector on the controller board.

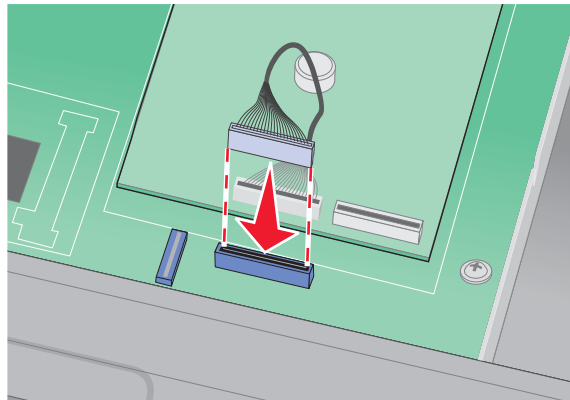

Note: If a printer hard disk was previously attached, reinstall it at this time.

12. Lower the scanner assembly and lock it.

Printer hard disk removal

1. Unplug the printer hard disk interface cable from the system board.

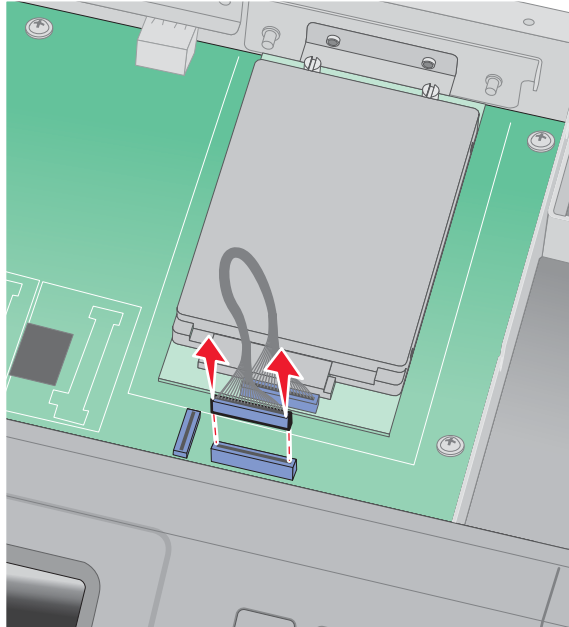

2. Remove the screws holding the printer hard disk in place.

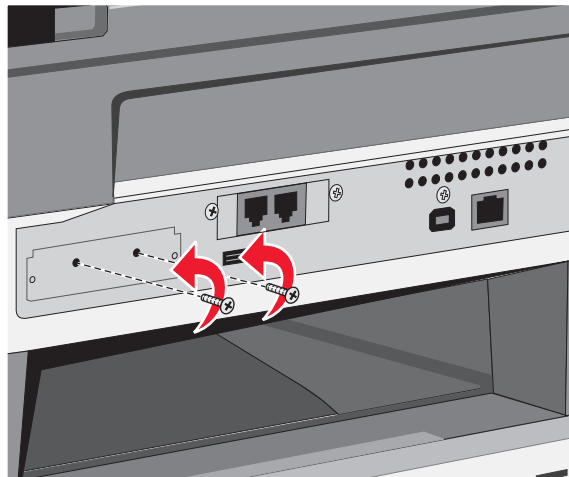

3. Remove the printer hard disk by pulling it upwards from the standoffs.

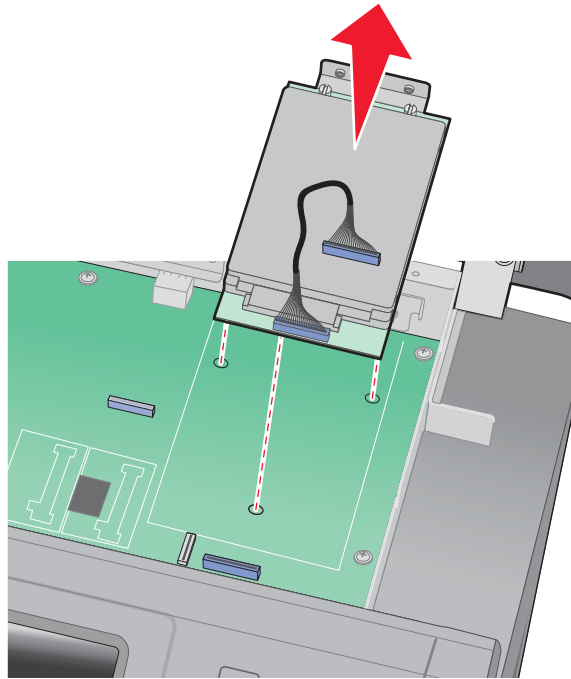

4. Remove the thumbscrews that attach the printer hard disk mounting bracket to the printer hard disk if the drive is going to be installed on top of an ISP.

Printer hard disk installation on an ISP

1. Access the controller board. See **“Lifting the Scanner to the up position”** on page 4-105.
2. Unpack the printer hard disk.
3. Locate the standoff location on the controller board.

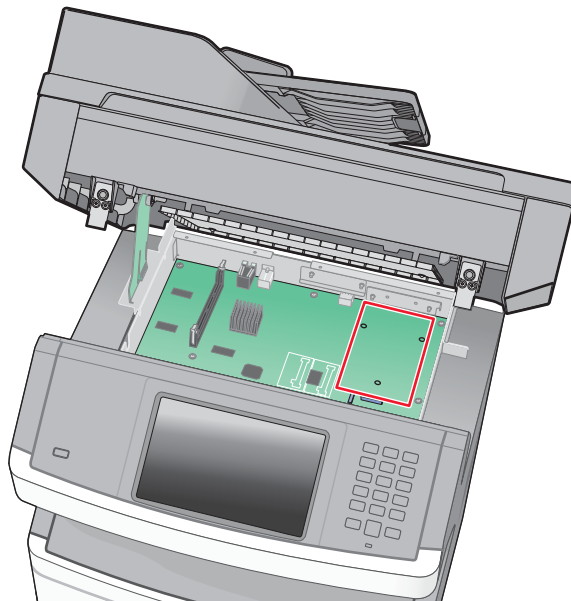

4. Use a flatblade screwdriver to remove the screws attaching the mounting bracket.

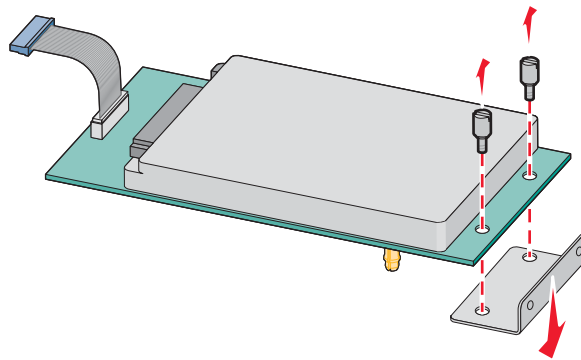

5. Place the hard disk on top of the ISP, making sure the standoff on the hard drive line up with the holes on the ISP.

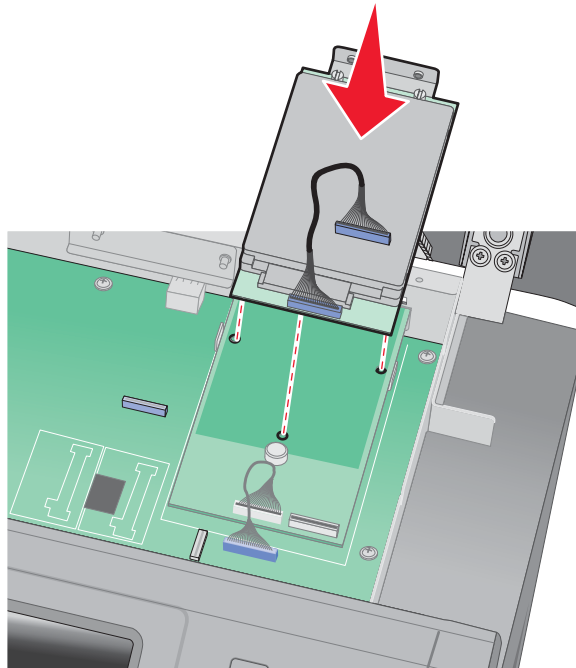

6. Gently press down on the hard drive until it locks into place.
7. Fasten the hard drive connector into the connector on the ISP card.

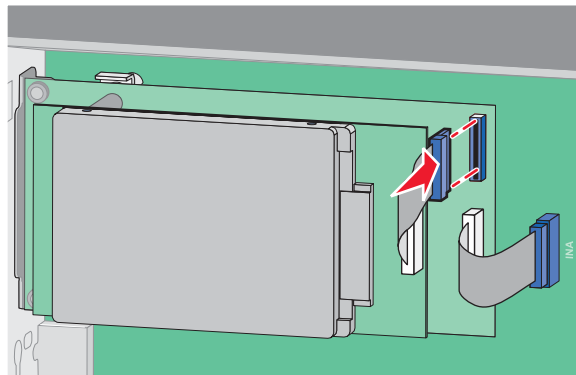

Printer hard disk installation directly on the controller board

Note: Perform steps 1, 2, and 3 from above. before doing the rest of the installation.

1. Align the printer hard disk standoffs with the holes on the system board.

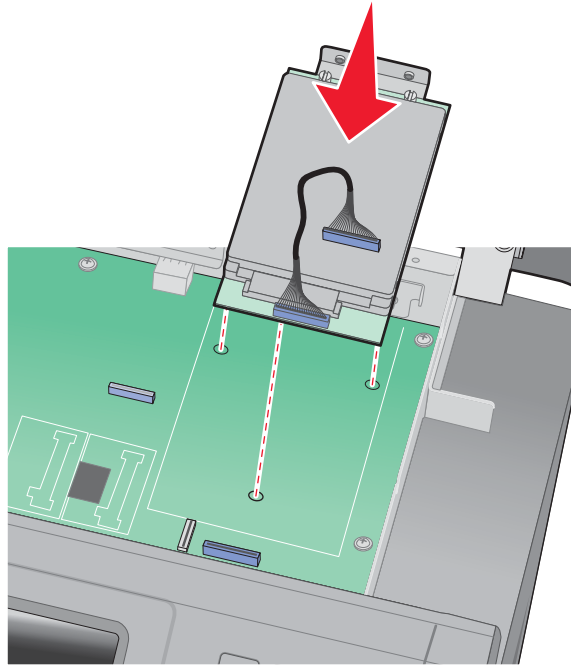

2. Press the hard disk down until it locks into place.
3. Attach the hard disk to the controller board cage using the screws that came with the hard disk.

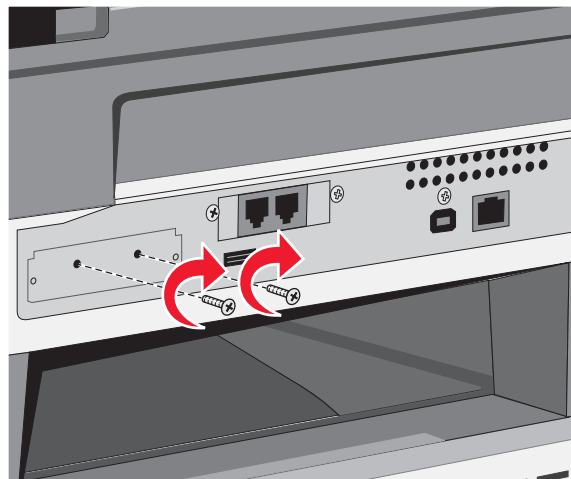

4. Connect the hard disk interface cable to the connector on the controller board.

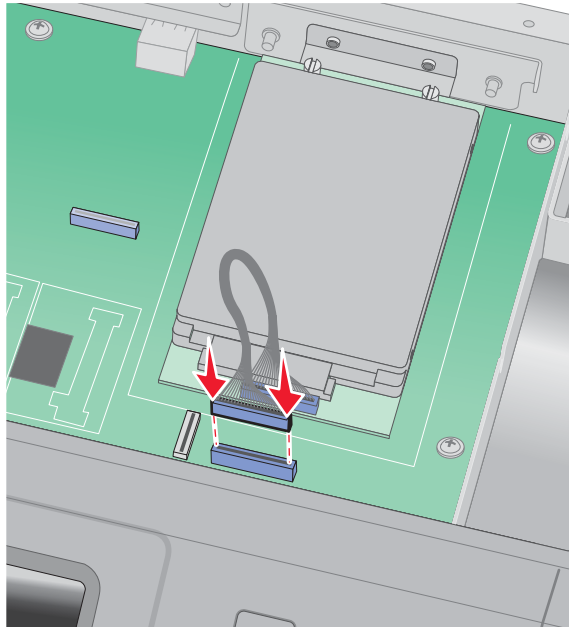

Fax card installation

1. Access the controller board.
2. Unpack the fax card,
3. Remove the fax card cover on the controller board cage.

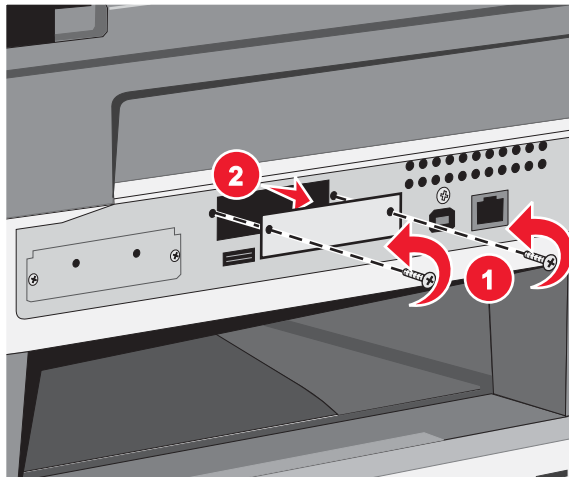

4. Insert the fax card into the controller board cage.

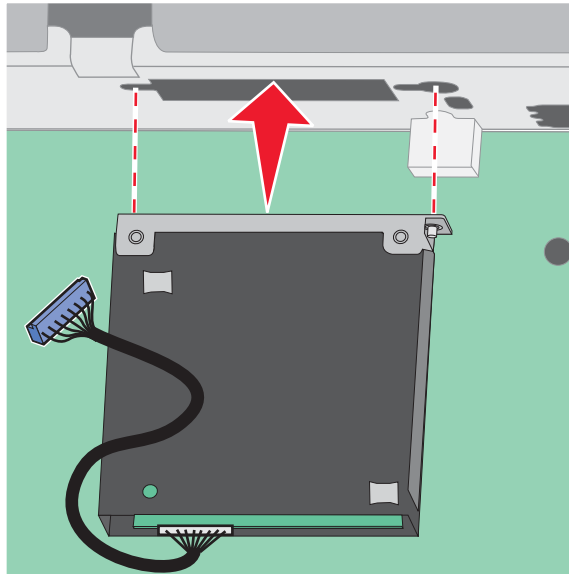

5. Tighten the two screws to secure it to the controller board cage.

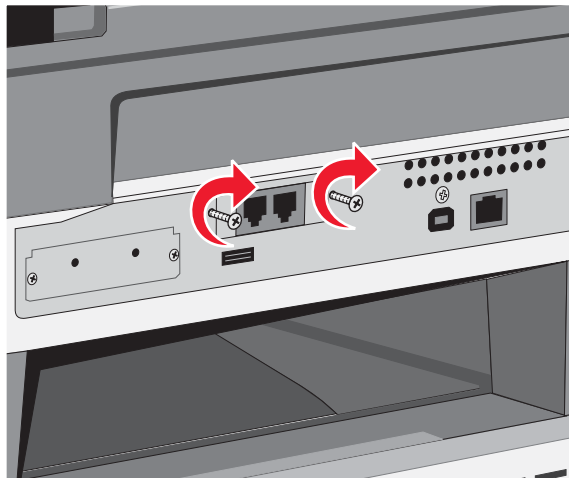

6. Insert the fax card interface cable into the system board connector.

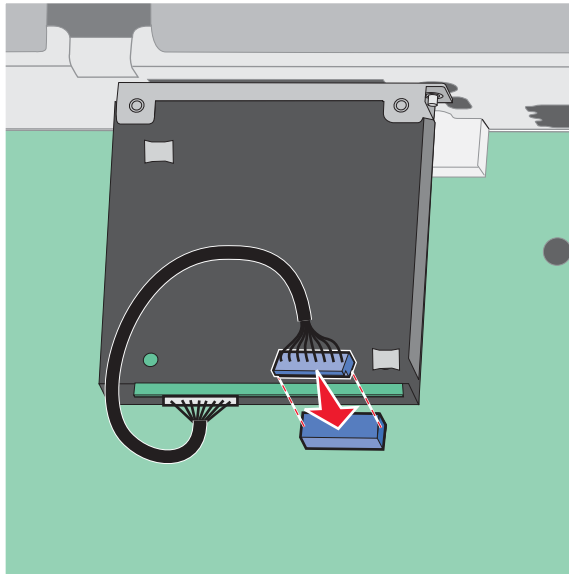

7. Lower and lock the scanner assembly.

5. Locations and connections

Locations

Front view

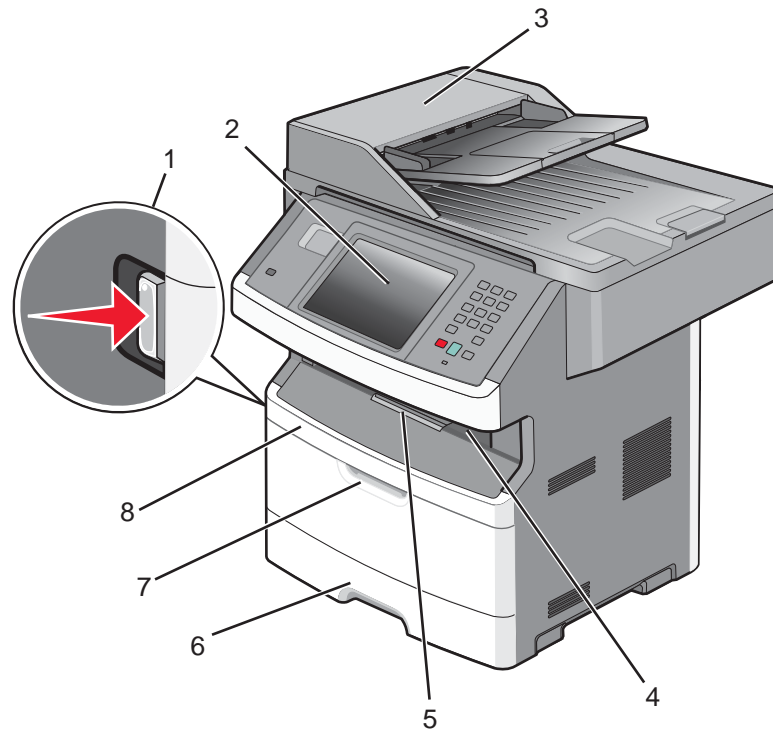

Callout number	Item name
1	Front door release button
2	E-Task display / Operator panel
3	ADF unit
4	Output bin / cave
5	Output bin extension
6	Standard input tray
7	MFP input tray
8	Front cover access

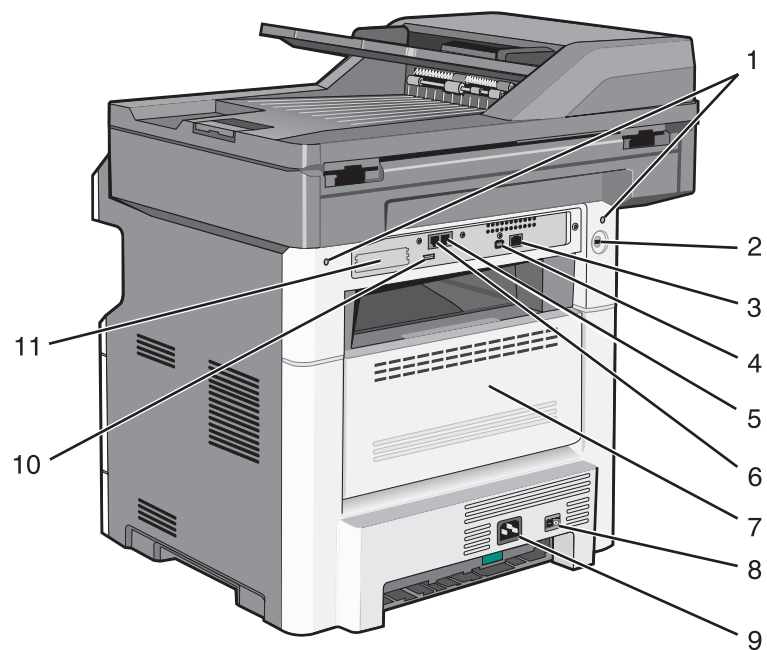
Rear view

Callout number	Item name
1	Scanner locks
2	Kensington lock
3	Ethernet port
4	Host USB port
5	Fax /
6	Fax /
7	Rear door
8	Power switch
9	Power
10	Rear USB
11	ISP / Options cover

Print engine paperpath

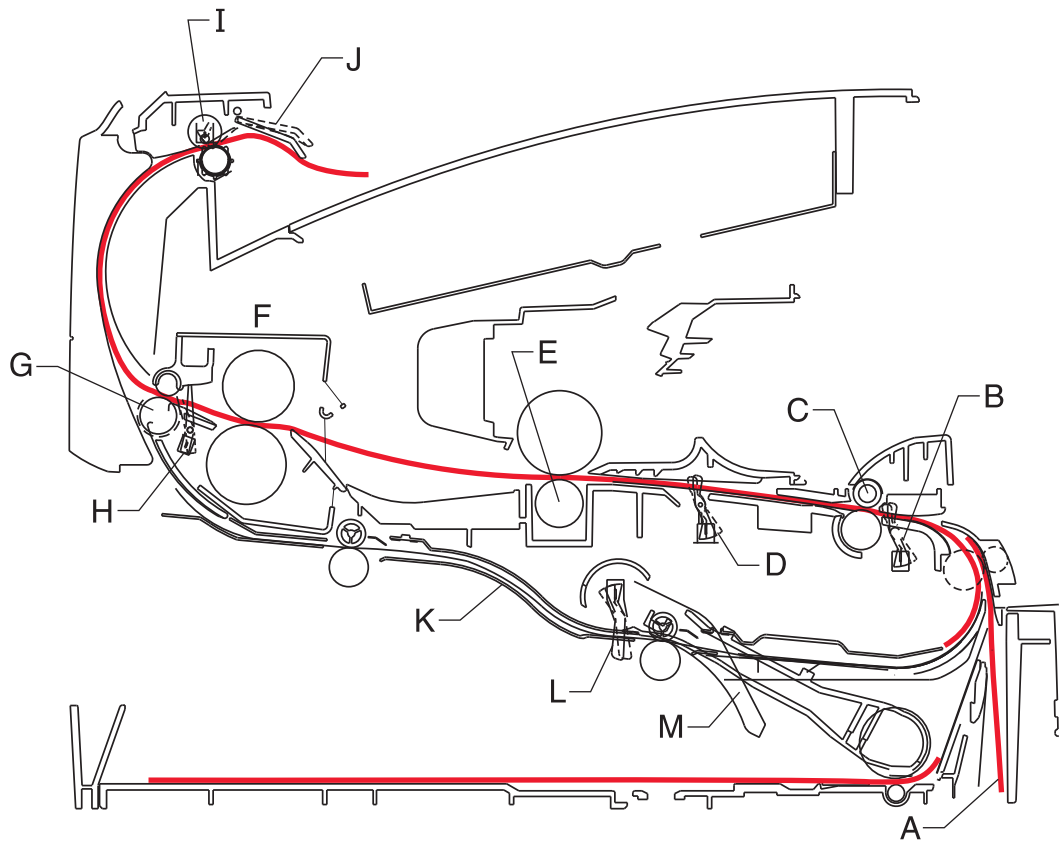

A	Paper path	A - B	125.3
B	Manual feed sensor	B - C	9.0
C	Upper end feed rolls	C - D	59.8
D	Input sensor	D - E	44.9
E	Transfer roll	E - F	112.7
F	Fuser	F - G	21.4
G	Fuser exit rolls	G - H	114.8
H	Fuser exit sensor	H - I	7.5
I	Exit rolls	I - J	17.0
J	Exit sensor/narrow media sensor	I - K	211.7
K	Duplex unit	K - L	93.4
L	Duplex sensor	L - M	8.4
M	Auto compensator	M - B	177.2

Main boards

Lexmark X46x series controller board

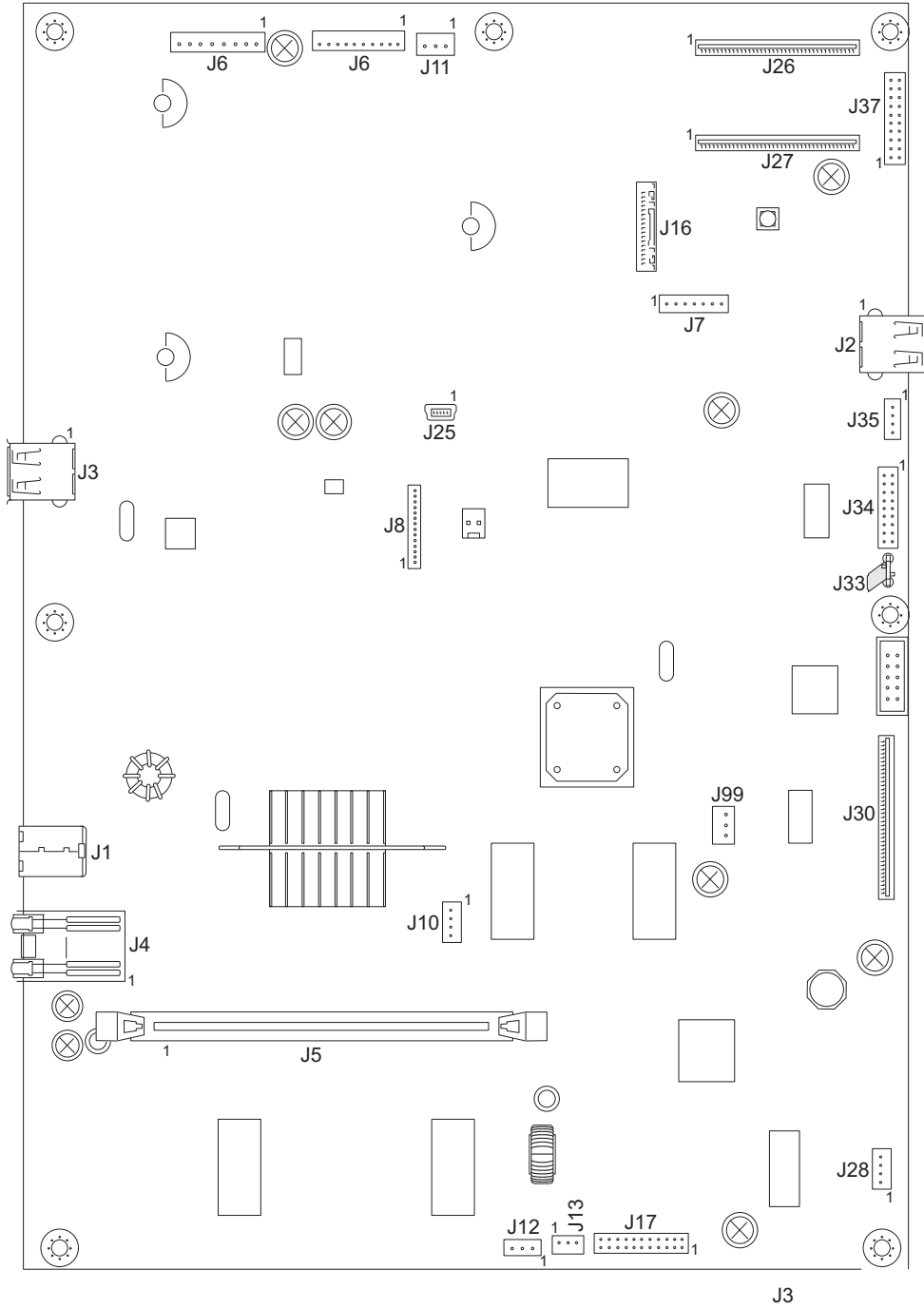

Lexmark X46x series engine board

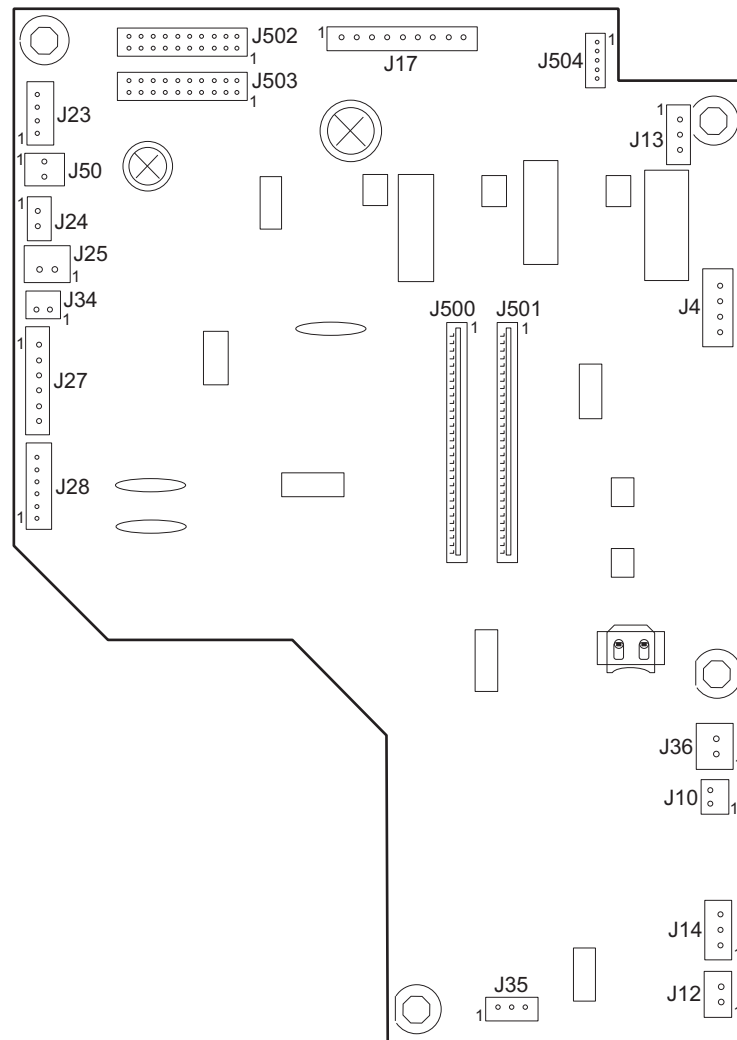

Lexmark X46x controller and engine board connector pin values

Note: The connections listed below are located on the controller board or the engine board. The comments column lists which board the connection appears on.

These values were measured with all connections made (plugged) or with only one connector at a time unplugged to expose the pins. Always disconnect and connect with the printer power off. Otherwise, the values below may not match.

Connector	Pin #	Value cable plugged	Value cable unplugged (if different)	Comments
J8	1, 3, 5, 7, 9, 11, 14	Signals		Modem - Controller Board
	10	5 V dc		
	12, 13	3.3 V dc		
	2, 4, 6, 8	Ground		
J16	10, 12, 14	+5V		ISP - Controller Board
	1, 4 7	Ground		
J7	1	+5V		Cave light - Controller board
	4	Ground		
J99	3	+3.3V		Controller cooling fan - Controller board
	1	Ground		
J4	1	Ground		Cartridge - Engine Board (The front access door must be closed.)
	2	1.7 V dc		
	3, 4	3.3 V dc		
J34	1, 3, 5, 6	3.3 V dc		Operator panel (UICC) - Controller Board
	10, 16 ,17, 18	5.0 V dc		
	2, 9, 15	Ground		
J6	1	> 0 V dc	5 V dc	Printhead - Controller Board
	2, 3	5 V dc		
	4, 5, 6, 7	Ground		
J11	1	5 V dc (door closed)		Cover open - Controller Board
		0 V dc (door open)		
	2	5 V dc		
	3	Ground		
J9	1, 10	5 V dc		LSU - Controller Board
	9	2.9 V dc		
J36	1	24 V dc	0 V dc	Cooling fan - Engine Board
	2	24 V dc		
J10	1	24 V dc	24 V dc	Duplex solenoid - Engine Board
	2	24 V dc	0 V dc	
J35	1		5 V dc	Narrow media sensor - Engine Board
	2	5 V dc	5 V dc	
	3	Ground		

Connector	Pin #	Value cable plugged	Value cable unplugged (if different)	Comments
J12	1	5 V dc		Thermistor - Engine Board
	2	Ground		
J13	1	0.6 V dc		Toner level sensor - Engine Board
	2	Ground		
	3	0 V dc		
J14	1	> 0 V dc	5 V dc	Fuser exit sensor - Engine Board
	2	5 V dc		
	3	Ground		
J17	1, 4	0.1 V dc	5 V dc	Main gear drive motor - Engine Board
	2, 3, 6	5 V dc		
	5	Ground		
	7, 8, 9	24 V dc		
J19				USB port - Controller Board
J23	1	1.1 V dc	5 V dc	Manual feed sensor - Engine Board
	2	5 V dc		
	3	Ground		
J24	1	24 V dc		MPF clutch - Engine Board
	2	24 V dc	0 V dc	
J25	1	24 V dc		Manual feed solenoid - Engine Board
	2	24 V dc	0 V dc	
J34	1	24 V dc		Media feed clutch - Engine Board
	2	24 V dc	0 V dc	
J27	1, 4	1.1 V dc	5 V dc	Input and duplex sensor - Engine Board
	2, 5	5 V dc		
	3, 6	Ground		
J28	1, 4	3.3 V dc		Tray 2 - Engine Board
	2	24 V dc		
	6	Ground		
J504	1	5 V dc		Toner patch (density) sensor - Engine Board
	3	1 V dc	0 V dc	
	4	Ground		
	5	5 V dc	0V dc	
J502	1, 3, 5, 7, 11, 13, 15		5V dc	LVPS - Engine Board
	4		5 V dc	
	6		24 V dc	
	17, 19		24 V dc	
	Other		0 V dc	

Connector	Pin #	Value cable plugged	Value cable unplugged (if different)	Comments
J503	11, 13 15		5V dc	HVPS - Engine Board
	17, 19		24V dc	
	10,12,14,16,18		Ground	
J37	11, 13 15		5V dc	PS (LVPS/HVPS) - Controller Board
	17, 19		24V dc	
	10,12,14,16,18		Ground	
J30	3, 4	+14V		AFE (CCD Ribbon) - Controller Board
	6, 7	+5V		
	1,5,13,15,18, 21,24,27,30, 31-36	GND		
J28	1	V12_A-		FB Motor - Controller Board
	2	V12_A		
	3	V12_B-		
	4	V12_B		
J17	14	+5V		ADF - Controller Board
	11, 12	+24V		
	3,5,8,10,13	GND		
J13	1	+5V		Home Sensor - Controller Board
	2	GND		
	3	HOME		
J12	1	GND		Paper Legnth (FB) - Controller Board
	2	P_LENGTH		
	3	+5V		

6. Preventive maintenance

This chapter describes procedures for printer preventive maintenance. Follow these recommendations to help prevent problems and maintain optimum performance.

Safety inspection guide

The purpose of this inspection guide is to aid you in identifying unsafe conditions.

If any unsafe conditions exist, then find out how serious the hazard could be and if you can continue before you correct the hazard.

Check the following items:

- Damaged, missing, or altered parts, especially in the area of the On/Off switch and the power supply
- Damaged, missing, or altered covers, especially in the area of the top cover and the power supply cover
- Possible safety exposure from any non-Lexmark attachments

Lubrication specifications

FRUs are typically lubricated as needed from the factory. If not, then lubricate only when parts are replaced or as needed, not on a scheduled basis. Use of lubricants other than those specified can cause premature failure. Some unauthorized lubricants may chemically attack parts. Use P/N 99A0394 (Nyogel 744) to lubricate appropriate areas. Lubricate gears that were lubricated in the original part.

Scanner glass cleaning

Kit 40X0392 is available for cleaning the scanner glass on the flatbed. Included are instructions for cleaning the ADF glass if streaks should appear on copies from the ADF.

Maintenance kits

Maintenance kits

Description	Part number
Low voltage (110 V) maintenance kit Note: The fuser maintenance kit installation is recommended every 120,000 pages. Note: The kit includes: <ul style="list-style-type: none"> • Fuser (P/N 40X5344) • Tray 1 ACM feed tires (P/N 40X5451) • Transfer roll (P/N 40X5364) 	40X5400
High voltage (220 V) maintenance kit Note: The fuser maintenance kit installation is recommended every 120,000 pages. Note: The kit includes: <ul style="list-style-type: none"> • Fuser (P/N 40X5345) • Tray 1 ACM feed tires (P/N 40X5451) Transfer roll (P/N 40X5364)	40X5401

Maintenance kits

Description	Part number
100 V maintenance kit Note: The fuser maintenance kit installation is recommended every 120,000 pages. Note: The kit includes: <ul style="list-style-type: none">• Fuser (P/N 40X5346)• Tray 1 ACM feed tires (P/N 40X5451) Transfer roll (P/N 40X5364)	40X5402
ADF Maintenance kit	40X5807
ADF separator roll	40X7545
ADF separator pad	40X8419
Exit guide	40X5372

7. Parts Catalog

How to use this parts catalog

The following legend is used in the parts catalog:

Asm-Index	Part number	Units/mach	Units/FRU	Description
-----------	-------------	------------	-----------	-------------

- **Asm-index:** identifies the assembly and the item in the diagram. For example, 3-1 indicates assembly 3 and the item number 1.
- **Part number:** identifies the unique number that identifies this FRU.
- **Units/mach:** refers to the number of units actually used in the machine or product.
- **Units/FRU:** refers to the number of units packaged together and identified by the part number.
- **NS:** (Not shown) in the Asm-Index column indicates that the part is procurable but is not pictured in the illustration.
- **PP:** (Parts Packet) in the parts description column indicates the part is contained in a parts packet.
- Model information used in the parts catalog.

Machine type and model	Description
7014-431	Lexmark X463de
7014-636	Lexmark X464de
7014-637	Lexmark X466de and X466dte
7014-63w	Lexmark X466dwe

Assembly 1: Covers

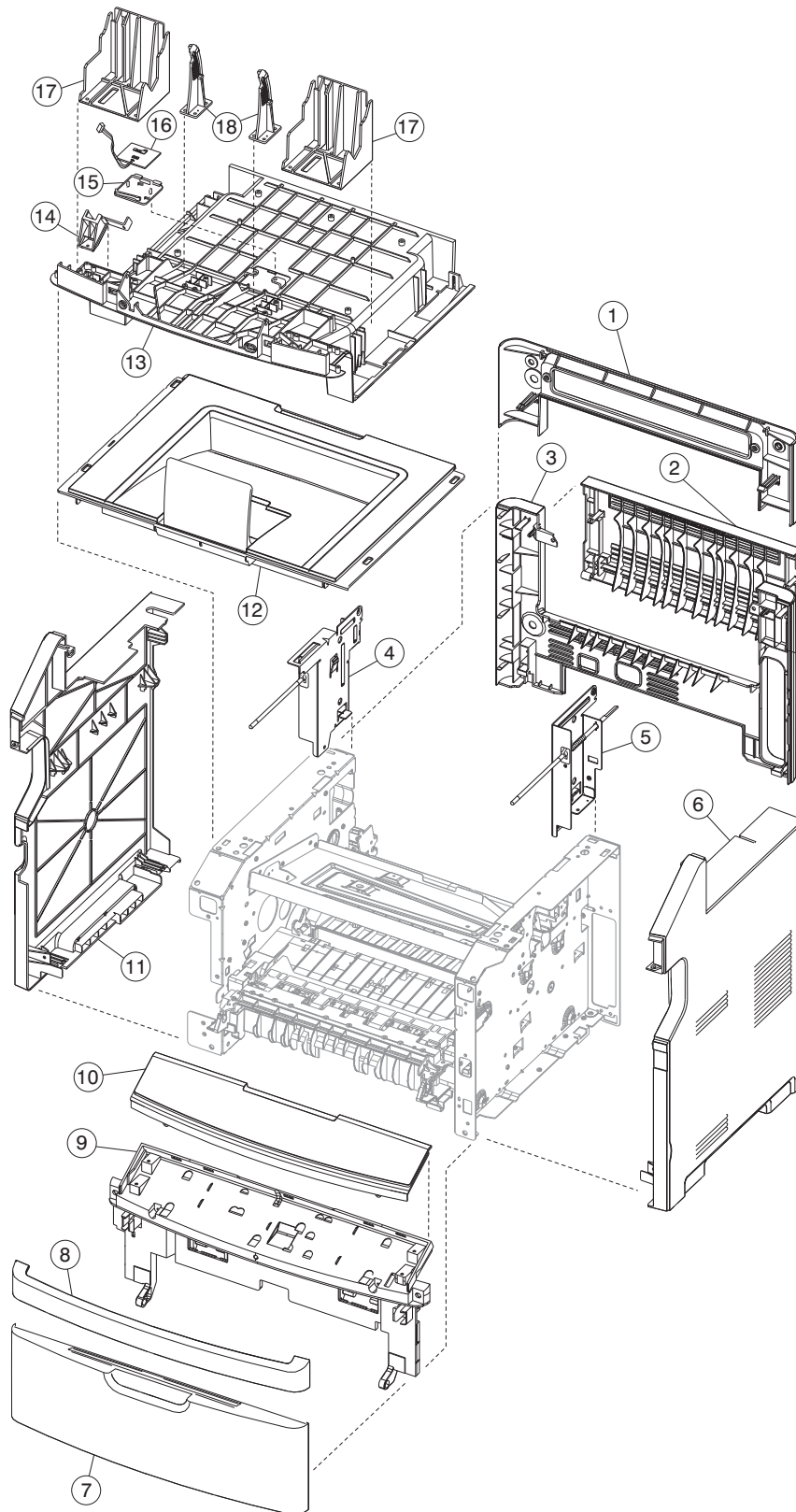

Assembly 1: Covers

Asm-Index	Part number	Units/mach	Units/FRU	Description
1-1	40X5827	1	1	Mid rear cover
2	40X5839	1	1	Rear door
3	40X5838	1	1	Rear cover
4	40X5820	1	1	Rear left frame assembly
5	40X5821	1	1	Rear right frame assembly
6	40X5822	1	1	Right side cover
7	40X5379	1	1	Front door cover
8	40X5359	1	1	Nameplate cover
9	40X5806	1	1	Lower AIO access assembly
10	40X5778	1	1	Front access door cover
11	40X5823	1	1	Left side cover
12	40X5614	1	1	Top cover assembly
13	40X5811	1	1	Tub cover assembly
14	40X5809	1	1	USB cable mount bracket
15	40X5834	1	1	Output bin LED lens
16	40X5835	1	1	Output bin LED
17	40X5815	2	1	Op panel support
18	40X5814	2	1	Display rotation support
NS	40X5381	1	1	Primary tray

Assembly 2: Imaging

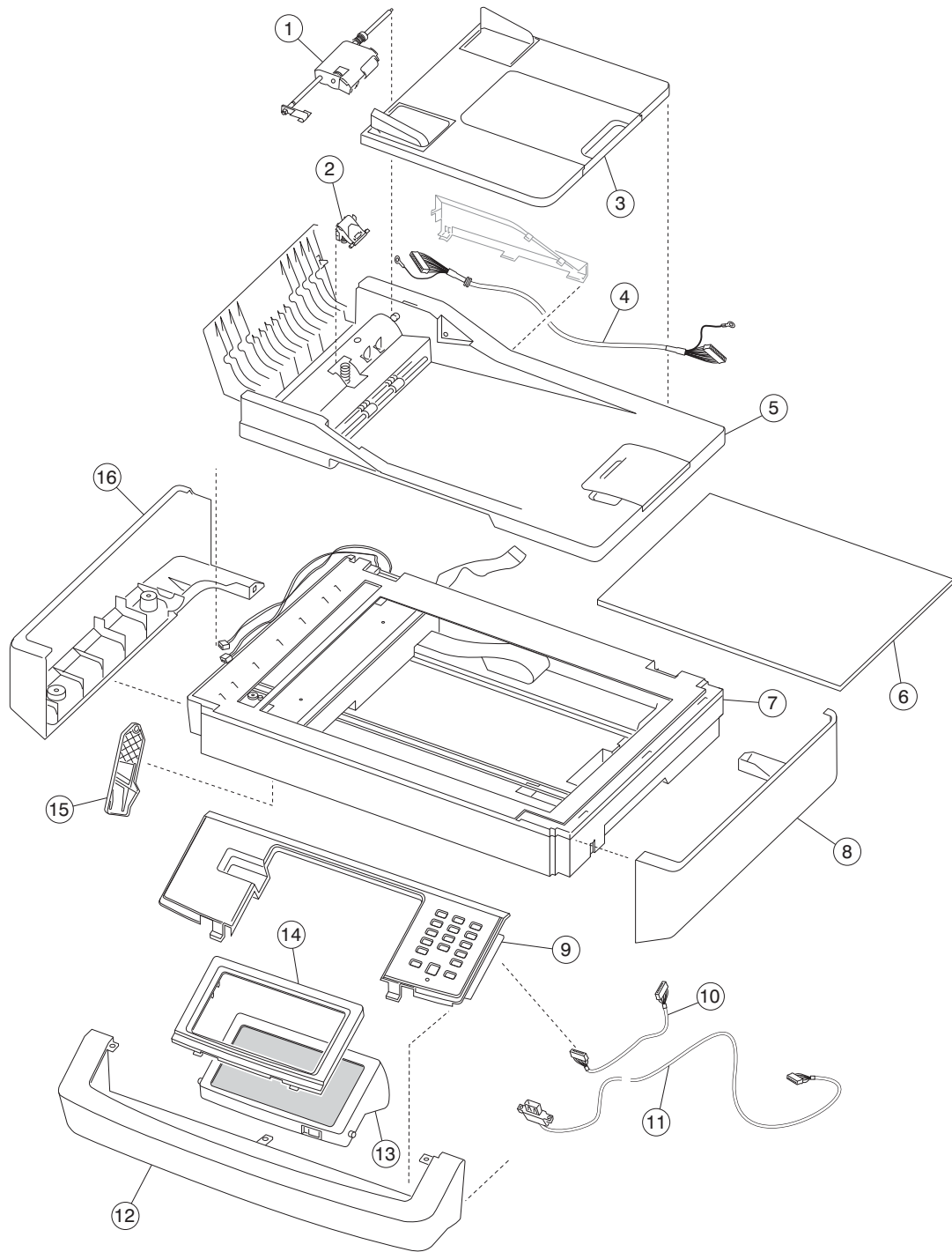

Assembly 2: Imaging

Asm-Index	Part number	Units/mach	Units/FRU	Description
1	40X7545	1	1	ADF Separator roll
2	40X8419	1	1	ADF Separator pad
3	40X5470	1	1	ADF input tray
4	40X5540	1	1	ADF cable
5	40X5824	1	1	Duplex ADF unit
6	40X5804	1	1	Flatbed cushion
7	40X5825	1	1	Flatbed module
8	40X5818	1	1	Right scanner cover
9	40X5836	1	1	Operator panel button assembly
10	40X5810	1	1	UICC Cable (Operator panel cable)
11	40X5831	1	1	Operator panel USB cable
12	40X5826	1	1	Scanner front cover
13	40X5837	1	1	Op panel display
14	40X0399	1	1	Op panel display bezel X463
14	40X0400	1	1	Op panel display bezel X464
14	40X0401	1	1	Op panel display bezel X466
15	40X5813	1	1	Kickstand support
16	40X5819	1	1	Left scanner cover
NS	40X5807	1	1	ADF maintenance kit
NS	40X7546	1	1	ADF hinge, right
NS	40X7547	1	1	ADF hinge, left

Assembly 3: Tray assemblies

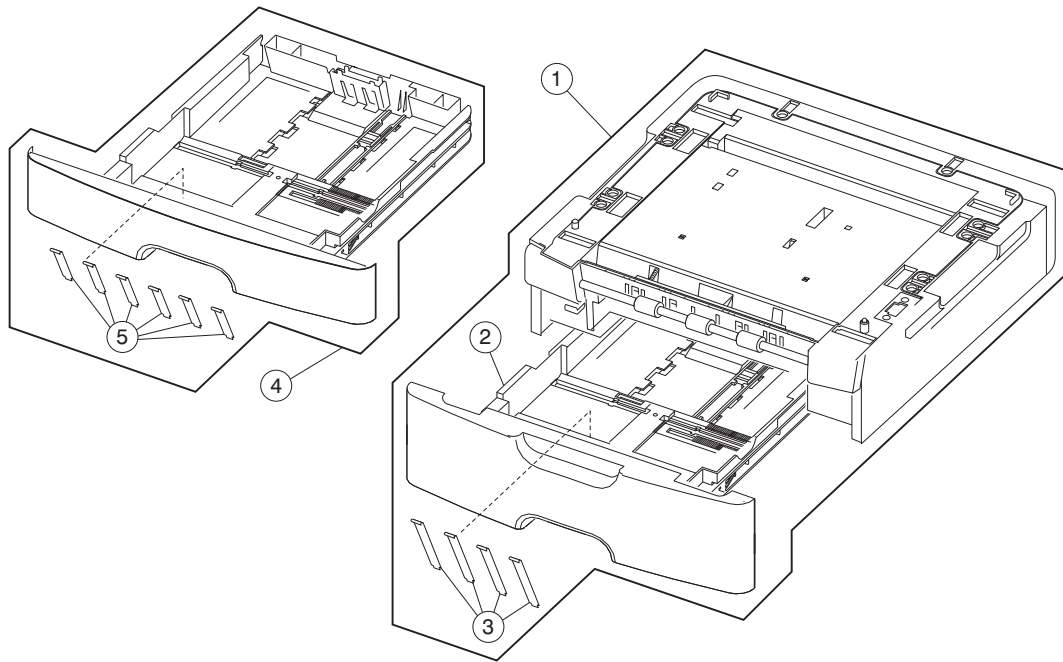

Assembly 3: Tray assemblies

Asm-Index	Part number	Units/mach	Units/FRU	Description
3-1	40X5398	1	1	Optional 250-sheet tray (new asm)
1	40X5399	1	1	Optional 550-sheet tray(new asm)
2	40X5394	1	1	250-sheet (Tray 2) assembly (new asm)
2	40X5395	1	1	550-sheet (Tray 2) assembly (new asm)
3	40X2855	1	4	Tray 2 wear strips (550-sheet tray only) (new asm)
4	40X5381	1	1	Primary tray
5	40X5382	1	6	Wear strips (250-sheet trays, optional and primary) (new asm)

Assembly 4: Electronics 2

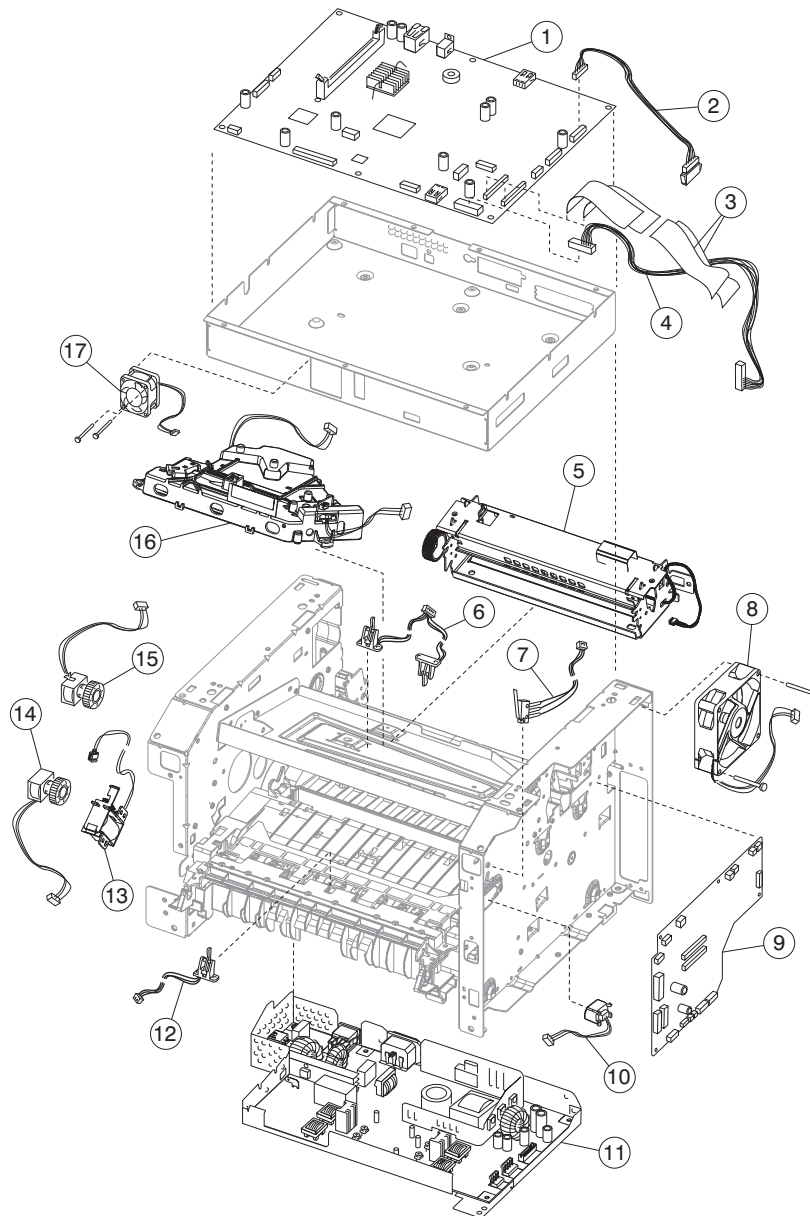

Assembly 4: Electronics 2

Asm-Index	Part number	Units/mach	Units/FRU	Description
4-1	40X5829	1	1	Controller board
2	40X5816	1	1	LSU hsync extension cable
3	40X5832	1	2	Stairway cable
4	40X5833	1	1	Controller board cable
5	40X5344	1	1	Fuser assembly, 115 V
5	40X5345	1	1	Fuser assembly, 230 V
5	40X5346	1	1	Fuser assembly, 100 V
6	40X5365	1	1	Duplex and media sensor assembly
7	40X5360	1	1	Access door open sensor assembly
8	40X5392	1	1	Cooling fan (screws included)
9	40X5830	1	1	Engine board,
10	40X5385	1	1	Toner low sensor
11	40X5842	1	1	LVPS/HVPS card assembly, 110 V
11	40X5841	1	1	LVPS/HVPS card assembly, 220 V
12	40X5366	1	1	Manual input sensor assembly
13	40X5369	1	1	Manual feed solenoid
14	40X5371	1	1	MPF feed clutch
15	40X5370	1	1	Media feed (ACM) clutch
16	40X5387	1	1	LSU, (printhead)
17	40X5805	1	1	Controller board fan
NS	40X5817	1	1	LSU laser diode cable

Assembly 5: Frame

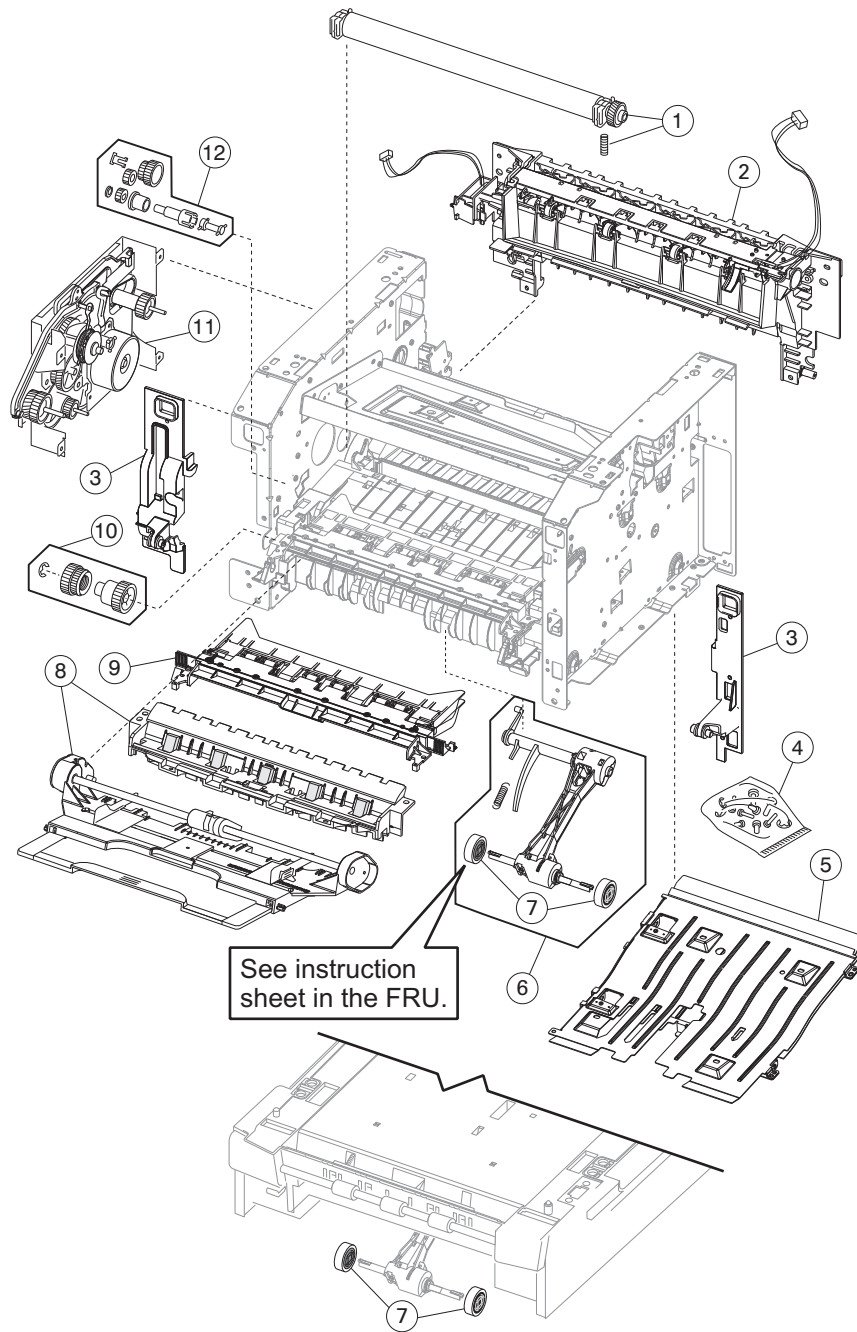

Assembly 5: Frame

Asm-Index	Part number	Units/mach	Units/FRU	Description
5-1	40X5364	1		Transfer roll, bearings, gear, spring (CBM)
2	40X5372	1		Media exit guide assembly (redrive)
3	40X5397	1	1	Front mounts
4	40X5396	N/A		Screws, miscellaneous
			4	TP2NCX3X6PF-Ni
			4	TP2C-4.0+8PF-Ni
			4	M3.0*0.5+6PF-Ni
			2	M3.0*0.5+4PF-Ni
			2	M3.5*0.6+6P-Ni
5	40X5380	1	1	Complete duplex assembly
6	40X5453	1	1	Media (ACM) drive assembly
7	40X5451	2	2	Paper feed, ACM tires
7	40X5440	1	2	Tray 2 paper feed tires
8	40X5358	1	1	MPF tray assembly
9	40X5383	1	1	Upper front frame assembly
10	40X5368	1	1	Manual feed clutch CBM
11	40X5367	1	1	Main drive gearbox (in motor)
12	40X5363	1	1	Duplex gear drive CBM
NS	40X5400	1	1	110 V maintenance kit
NS	40X5401	1	1	220 V maintenance kit
NS	40X5402	1	1	100 V maintenance kit
				Note: Kit contains the following: Fuser (40X5344, 40X5345, or 40X2802) Exit guide (40X5372) Tray 1 ACM feed tires (40X5451) Transfer roll CBM (40X5364)

Assembly 6: Options

Asm-Index	Part number	Units/mach	Units/FRU	Description
NS	40X5972	1	1	Japanese font card assembly
NS	40X5970	1	1	Simplified Chinese font card assembly
NS	40X5971	1	1	Traditional Chinese font card assembly
NS	40X5969	1	1	Korean font card assembly
NS	40X5952	1	1	Print crypton card assembly
NS	40X5951	1	1	Korean KS/KSSM/KSP
NS	40X5940	1	1	Bar code and forms
NS	40X5937	1	1	128MB DIMM
NS	40X5938	1	1	256MB DIMM
NS	40X5939	1	1	512MB DIMM
NS	40X5704	1	1	256MB flash
NS	40X1367	1	1	Parallel cable, packaged (3 m)
NS	40X1368	1	1	USB cable, packaged (2 m)
NS	40X4822	1	1	80 GB Hard Disk Drive
NS	40X5057	1	1	80 GB Hard Disk Drive TAA
NS	40X5038	1	1	Wireless ISP Adapter (US)
NS	40X5039	1	1	Wireless ISP Adapter (EMEA)
NS	40X5318	1	2	Thumbscrews
NS	40X4821	1	1	N.8110 V.34 Fax
NS	40X5606	1	1	14 Pin JST for Fax Cable
NS	56P0558	1	1	RJ11 Cable w/Toroids
NS	40X4819	1	1	RS 232 Serial adapter
NS	40X4826	1	1	N8120 Gigabit INA
NS	40X5315	1	2	ISP screw
NS	40X5316			14 Pin JST for ISP Cable
NS	40X5317	1	1	Standoff Tee w/thumbscrew
NS	40X4823	1	1	Parallel 1284-B thick adapter
NS	40X4827	1	1	N8130 10/100 Fiber adapter
NS	7377732	1	1	Relocation Kit

Assembly 7: Power cords

Asm-Index	Part number	Units/mach	Units/FRU	Description
NS	40X0297	1	1	Power cord, 1.8M (straight)—USA, Canada
NS	40X0278	1	1	Power cord, 6 foot (straight)—Europe and others
NS	40X0288	1	1	Power cord, 8 foot (straight)—Argentina
NS	40X0286	1	1	Power cord, 8 foot (straight)—United Kingdom
NS	40X0275	1	1	Power cord, 6 foot (straight)—Israel
NS	40X0274	1	1	Power cord, 6 foot (straight)—Switzerland
NS	40X0276	1	1	Power cord, 6 foot (straight)—South Africa
NS	40X0287	1	1	Power cord, 6 foot (straight)—Traditional Italy
NS	40X0279	1	1	Power cord, 6 foot (straight)—Denmark
NS	40X0277	1	1	Power cord, 6 foot (straight)—Brazil
NS	40X0282	1	1	Power cord, 1.8M (straight)—PRC
NS	40X0270	1	1	Power cord, 2.5M (straight)—Japan
NS	40X0280	1	1	Power cord, 1.8M (straight)—Korea
NS	40X0281	1	1	Power cord, 1.8M (straight)—Taiwan
NS	40X0296	1	1	Power cord, 1.8M (straight)—Australia

Index

Numerics

840.xx service check **2-55**

A

abbreviations **1-14**

acronyms **1-14**

ADF cover open service check **2-59**

ADF duplex service check **2-62**

ADF feed errors service check **2-60**

ADF paper jam service check **2-60**

ADF separator pad

removal **4-98**

ADF separator roll

removal **4-99**

ADF streak service check **2-59**

ASIC Test **3-34**

B

Button Test **3-21**

buttons

accessing service menus **3-1**

Button Test **3-21**

C

CCD service check **2-57**

compatibility **1-3**

Configuration ID **3-30**

Configuration Menu

Reset Maintenance Counter **3-3**

configuration menu

accessing **3-1**

available menus **3-2**

Factory Defaults **3-6**

Panel Menus **3-4**

PPDS Emulation **3-5**

D

defaults

EP defaults **3-31**

factory defaults **3-6**

US/Non-US defaults **3-29**

diagnostics menu

DEVICE TESTS

Disk Test/Clean **3-28**

Quick Disk Test **3-28**

DUPLEX TESTS

Duplex Feed 1 **3-26**

Duplex Feed 2 **3-26**

Motor Test **3-25**

Quick Test **3-24**

Sensor Test **3-25**

Top Margin **3-25**

EP SETUP

Charge Roll **3-32**

EP Defaults **3-31**

Fuser Page Count **3-31**

Fuser Temp **3-31**

Gap Adjust **3-32**

Print Contrast **3-32**

Transfer **3-32**

Warm Up Time **3-31**

EVENT LOG

Clear Log **3-33**

Display Log **3-32**

Print Log **3-33**

HARDWARE TESTS

Button Test **3-21**

DRAM Test **3-22**

Panel Test **3-21**

INPUT TRAY TESTS

Feed Test **3-26**

Sensor Test **3-26**

OUTPUT BIN TESTS

Feed Test **3-27**

Sensor Tests **3-27**

PRINTER SETUP

Configuration ID **3-30**

Defaults **3-29**

Edge to Edge **3-30**

engine settings **3-29**

Model Name **3-29**

Page Count **3-29**

Perm Page Count **3-29**

Serial Number **3-29**

SCANNER TESTS

ASIC Test **3-34**

Feed Test **3-34**

Sensor Tests **3-34**

diagnostics mode **3-17**

accessing **3-1**

available tests **3-17**

diagnostics mode—

Registration **3-18**

digital imaging specifications **1-9**

DRAM Test **3-22**

duplex tests

Duplex Feed 1 **3-26**

Duplex Feed 2 **3-26**

Motor Test **3-25**

Quick Test **3-24**

Sensor Test **3-25**

Top Margin **3-25**

E

Edge to Edge **3-30**

Engine Setting **3-29**

error messages

service error codes **2-26**

user attendance messages **2-13**

ESD-sensitive parts **4-1**

event log
 clear log (diagnostics menu) **3-33**
 display log (diagnostics mode) **3-32**
 print log (diagnostics menu) **3-33**

F

fan
 parts catalog **7-9**
 service check **2-37**
 fax reception service check **2-66**
 fax specifications **1-12**
 miscellaneous **1-12**
 phone network connectivity **1-12**
 scan resolutions **1-12**
 fax transmission service check **2-64**
 Feed Test (scanner) **3-34**
 flatbed home position service check **2-58**
 flatbed motor service check **2-57**
 frame, parts catalog **7-10**
 fuser
 parts catalog **7-9**
 service check **2-39**

G

gap adjustment **3-32**

H

handling ESD-sensitive parts **4-1**

I

input sensor tray tests **3-26**
 input tray feed test **3-26**

L

lithium battery **v-xvii, 4-8, 4-15**
 locations
 front views **5-1**
 rear views **5-2**
 lubrication specifications **6-1**
 LVPS/HVPS
 parts catalog **7-9**
 service check **2-39**

M

maintenance approach **1-1**
 maintenance kits **6-1**
 manually register a duplex ADF **3-8**
 manually register the flatbed **3-8**
 media
 guidelines **1-6**
 recycled **1-7**
 unacceptable media **1-6**
 menus
 accessing service menus **3-1**
 messages
 service error codes **2-26**
 user attendance messages **2-13**
 Model Name **3-29**
 models
 diagrams **5-1, 5-2**
 trays available **1-4**

modem - fax card service check **2-63**

O

operator panel
 Button Test **3-21**
 LCD— **2-5**
 LED—
 service check **2-43**
 Panel Test **3-21**
 output bin sensor tests **3-27**

P

page count
 Fuser Page Count **3-31**
 Page Count **3-29**
 permanent page count **3-29**
 Panel Test **3-21**
 paper
 guidelines **1-6**
 recycled **1-7**
 unacceptable paper **1-6**
 parts catalog
 covers **7-2**
 electronics **7-8**
 frame **7-10**
 options **7-12**
 power-on self test (POST) **2-1**
 symptoms **2-2**
 print media
 trays by model **1-4**
 types and sizes **1-5**
 print quality pages
 using **2-47**
 print quality problems
 service check **2-47**
 solving **2-51**
 printer symptom table **2-3**
 printhead
 service check **2-54**

Q

Quick Disk Test **3-28**
 Quick Test **3-24**

R

registration **3-18**
 removals
 ADF separator pad **4-98**
 ADF separator roll **4-99**
 covers
 front access cover **4-8**
 procedures **4-2**

S

safety information **v-xvii**
 safety inspection guide **6-1**
 scan and copy specifications **1-11**
 scan fax and copy symptoms **2-4**
 SE Menu **3-41**
 serial number **3-29**

- service checks **2-35**
 - ADF paperfeed **2-60**
 - ADF streak **2-59**
 - black page **2-57**
 - cooling fan **2-37**
 - cover interlock switch **2-37**
 - dead machine **2-38**
 - flatbed **2-58**
 - flatbed motor **2-57**
 - fuser **2-39**
 - LVPS/HVPS **2-39**
 - main motor **2-40**
 - modem / fax card **2-63**
 - networking **2-41**
 - operator panel **2-43**
 - paper feed **2-43**
 - paper jam during POST **2-43**
 - paper never picks **2-44**
 - paper picks but stops **2-44**
 - paper picks sheets **2-44**
 - paper trees, curls **2-45**
 - print quality **2-47**
 - black page **2-48**
 - blank page **2-47**
 - heavy background **2-48**
 - image density **2-49**
 - light print **2-50**
 - partial blank image **2-49**
 - poor fusing of image **2-49**
 - toner on back of page **2-50**
 - white or black lines **2-50**
 - printhead **2-54**
 - scanner, fax, copy
 - 840xx error check **2-55**
 - ADF cover open **2-59**
 - ADF duplex service check **2-62**
 - ADF feed errors **2-60**
 - ADF paper am **2-60**
 - black page or blank page **2-57**
 - CCD service check **2-57**
 - escalating a fax issue to second-level support **2-68**
 - fax reception service check **2-66**
 - fax transmission service check **2-64**
 - flatbed home position **2-58**
 - flatbed motor **2-57**
 - modem service check **2-63**
 - transfer roll **2-54**
 - service error codes **2-26**
 - special tools **1-13**
 - specifications
 - connectivity **1-3**
 - digital imaging **1-9**
 - fax **1-12**
 - input trays **1-4**
 - memory **1-2**
 - operating systems **1-3**
 - photoconductor capacity **1-4**
 - print media **1-5**
 - scan and copy **1-11**
 - toner capacity **1-4**
 - start **2-1**
 - symptom tables **2-2**
 - POST **2-2**
 - printer **2-3**
 - symptoms
 - scan fax and copy **2-4**
- T**
- tools **1-13**
 - Top Margin **3-18**
 - duplex **3-25**
 - transfer roll
 - parts catalog **7-11**
 - service check **2-54**
- U**
- user attendance messages **2-13**
- W**
- warm up time **3-31**

Part number index

P/N	Description	Page
40X0270	Power cord, 1.77M (straight)—Japan	7-13
40X0274	Power cord, 6 foot—Switzerland	7-13
40X0275	Power cord, 6 foot (straight)—Israel	7-13
40X0276	Power cord, 6 foot—South Africa	7-13
40X0277	Power cord, 6 foot (straight)—Brazil	7-13
40X0278	Power cord, 6 foot (straight)—Europe and others	7-13
40X0279	Power cord, 6 foot (straight)—Denmark	7-13
40X0280	Power cord, 1.77M (straight)—Korea	7-13
40X0281	Power cord, 1.77M (straight)—Taiwan	7-13
40X0282	Power cord, 1.77M (straight)—PRC	7-13
40X0286	Power cord, 6 foot—United Kingdom	7-13
40X0287	Power cord, 6 foot (straight)—Traditional Italy	7-13
40X0288	Power cord, 6 foot—Argentina	7-13
40X0296	Power cord, 1.8M (straight)—Australia	7-13
40X0297	Power cord, 1.77M (straight)—USA, Canada	7-13
40X0399	Op panel display bezel X463	7-5
40X0400	Op panel display bezel X464	7-5
40X0401	Op panel display bezel X466	7-5
40X1367	Parallel cable, packaged (3 m) (E460dn only)	7-12
40X1368	USB cable, packaged (2 m)	7-12
40X2855	Tray 2 wear strips (550-sheet tray only)	7-7
40X4819	RS 232 Serial adapter	7-12
40X4821	N.8110 V.34 Fax	7-12
40X4822	80 GB Hard Disk Drive	7-12
40X4823	Parallel 1284-B thick adapter	7-12
40X4826	N8120 Gigabit INA	7-12
40X4827	N8130 10/100 Fiber adapter	7-12
40X5038	Wireless ISP Adapter (US)	7-12
40X5039	Wireless ISP Adapter (EMEA)	7-12
40X5057	80 GB Hard Disk Drive TAA	7-12
40X5315	ISP screw	7-12
40X5316	14 Pin JST for ISP Cable	7-12
40X5317	Standoff Tee w/thumb screw	7-12
40X5318	Thumb screws	7-12
40X5344	Fuser assembly, 115 V	7-9
40X5345	Fuser assembly, 230 V	7-9
40X5346	Fuser assembly, 100 V	7-9
40X5358	MPF tray assembly	7-11
40X5359	Nameplate cover	7-3
40X5360	Access door open sensor assembly	7-9
40X5363	Duplex gear drive CBM	7-11
40X5364	Transfer roll, bearings, gear, spring (CBM)	7-11
40X5365	Duplex and media sensor assembly	7-9
40X5366	Manual input sensor assembly	7-9
40X5367	Main drive gearbox (in motor)	7-11
40X5368	Manual feed clutch CBM	7-11
40X5369	Manual feed solenoid	7-9
40X5370	Media feed (ACM) clutch	7-9
40X5371	MPF feed clutch	7-9
40X5372	Exit guide	6-2
40X5372	Media exit guide assembly (redrive)	7-11
40X5379	Front door cover	7-3
40X5380	Complete duplex assembly	7-11
40X5381	Primary tray	7-3, 7-7

40X5382	Wear strips (250-sheet trays, optional and primary)	7-7
40X5383	Upper front frame assembly	7-11
40X5385	Toner low sensor	7-9
40X5387	LSU, E460dn/E460dw (printhead)	7-9
40X5392	Cooling fan (screws included)	7-9
40X5394	Tray 2 assembly	7-7
40X5395	550-sheet (Tray 2) assembly	7-7
40X5396	Screws, miscellaneous	7-11
40X5397	Front mounts	7-11
40X5398	Optional 250-sheet tray	7-7
40X5399	Optional 550-sheet tray	7-7
40X5400	110 V maintenance kit	7-11
40X5400	Low voltage (110 V) maintenance kit	6-1
40X5401	220 V maintenance kit	7-11
40X5401	High voltage (220 V) maintenance kit	6-1
40X5402	100 V maintenance kit	6-2, 7-11
40X5440	Tray 2 paper feed tires	7-11
40X5451	Paper feed, ACM tires	7-11
40X5453	Media (ACM) drive assembly	7-11
40X5470	ADF input tray	7-5
40X5540	ADF cable	7-5
40X5606	14 Pin JST for Fax Cable	7-12
40X5704	256MB flash	7-12
40X5804	Flatbed cushion	7-5
40X5805	Controller board fan	7-9
40X5807	ADF maintenance kit	6-2, 7-5
40X5810	UICC Cable (Operator panel cable)	7-5
40X5813	Kickstand support	7-5
40X5816	LSU hsync extension cable	7-9
40X5817	LSU laser diode cable	7-9
40X5818	Right scanner cover	7-5
40X5819	Left scanner cover	7-5
40X5824	Duplex ADF unit	7-5
40X5825	Flatbed module	7-5
40X5826	Scanner front cover	7-5
40X5829	Controller board	7-9
40X5830	Engine board	7-9
40X5831	Operator panel USB cable	7-5
40X5832	Stairway cable	7-9
40X5833	Controller board cable	7-9
40X5836	Operator panel button assembly	7-5
40X5837	Op panel display	7-5
40X5841	LVPS/HVPS card assembly, 220 V	7-9
40X5842	LVPS/HVPS card assembly, 110 V	7-9
40X5937	128MB DIMM	7-12
40X5938	256MB DIMM	7-12
40X5939	512MB DIMM	7-12
40X5940	Bar code and forms	7-12
40X5951	Korean KS/KSSM/KSP	7-12
40X5952	Print crypton card assembly	7-12
40X5969	Korean font card assembly	7-12
40X5970	Simplified Chinese font card assembly	7-12
40X5971	Traditional Chinese font card assembly	7-12
40X5972	Japanese font card assembly	7-12
40X7545	ADF Separator roll	6-2, 7-5
40X7546	ADF hinge, right	7-5
40X7547	ADF hinge, left	7-5
40X8419	ADF Separator pad	7-5
40X8419	ADF separator pad	6-2

56P0558	RJ11 Cable w/Toroids	-----	7-12
7377732	Relocation Kit	-----	7-12

